

400 W FOT-controlled PFC pre-regulator with the L6563S

Introduction

This application note describes a demonstration board based on the transition-mode PFC controller L6563S and presents the results of its bench evaluation. The board implements a 400 W, wide-range mains input, PFC pre-conditioner suitable for ATX PSU, flat screen displays, etc. The chip is operated with fixed off time control in order to use a low-cost device like the L6563S, which is usually prohibitive at this power level. Fixed-off-time control allows continuous conduction mode operation, which is normally achieved with more expensive control chips and more complex control architectures.

Figure 1. L6563S 400 W FOT PFC demonstration board (p/n EVL6563S-400W)

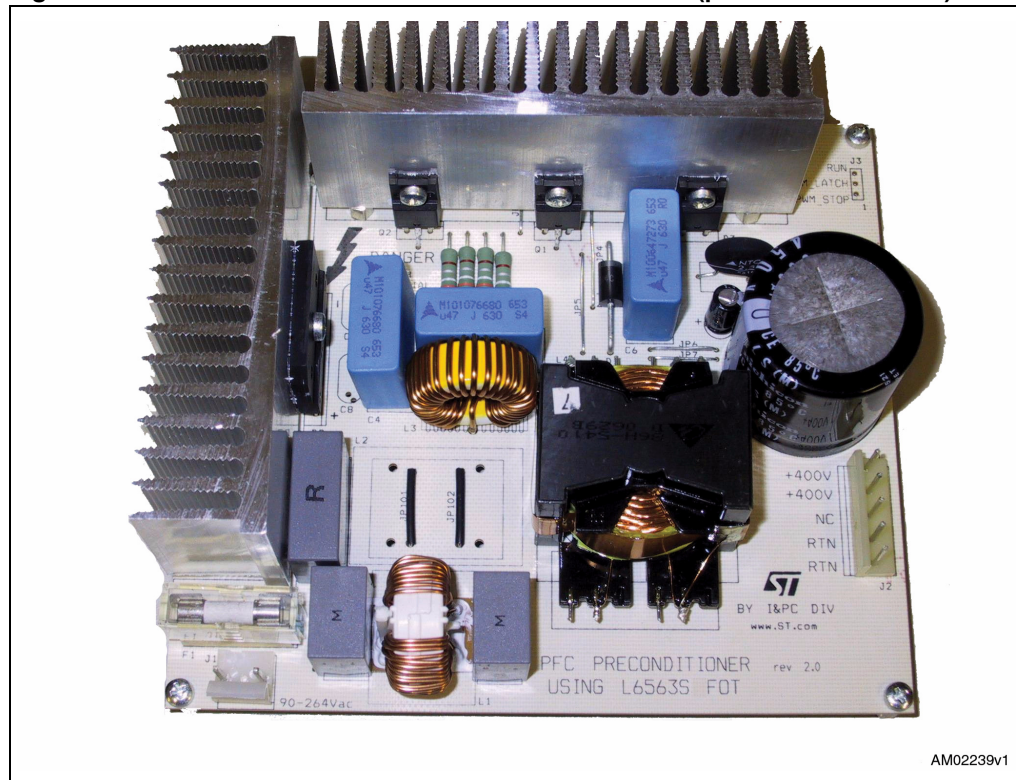

AM02239v1

Contents

1	Main characteristics and circuit description	5
2	Test results and significant waveforms	8
2.1	Harmonic content measurement	8
2.2	Inductor current in FOT and L6563S THD optimizer	12
2.3	Voltage feed-forward	14
2.4	Start-up and RUN pin	18
2.5	Brownout function	19
2.6	Start-up at light loads	21
2.7	Overvoltage and open-loop protection	22
2.8	Power management/housekeeping functions	24
3	Layout hints	26
4	Audible noise	28
5	Thermal measures	29
6	Conducted emissions pre-compliance tests peak detection	30
7	Bill of materials	31
8	PFC coil specification	34
8.1	General description and characteristics	34
8.2	Electrical characteristics	34
8.3	Mechanical aspects and pin numbering	35
9	References	36
10	Revision history	37

List of figures

Figure 1.	L6563S 400 W FOT PFC demonstration board (p/n EVL6563S-400W).	1
Figure 2.	EVL6563S-400W demonstration board: electrical schematic	7
Figure 3.	EVL6563S-400W compliance to EN61000-3-2 Standard at full load	8
Figure 4.	EVL6563S-400W compliance to JEITA-MITI Standard at full load.	8
Figure 5.	EVL6563S-400W compliance to EN61000-3-2 Standard at 70 W load	8
Figure 6.	EVL6563S-400W compliance to JEITA-MITI Standard at 70 W load.	8
Figure 7.	EVL6563S-400W input current waveform at 100 V, 60 Hz, 400 W load.	9
Figure 8.	EVL6563S-400W input current waveform at 230 V, 50 Hz, 400 W load.	9
Figure 9.	EVL6563S-400W input current waveform at 100 V, 60 Hz, 200 W load.	9
Figure 10.	EVL6563S-400W input current waveform at 230 V, 50 Hz, 200 W load.	9
Figure 11.	EVL6563S-400W input current waveform at 100 V, 60 Hz, 70 W load.	10
Figure 12.	EVL6563S-400W input current waveform at 230 V, 50 Hz, 70 W load.	10
Figure 13.	Power factor vs. Vin and load.	10
Figure 14.	THD vs. Vin and load	10
Figure 15.	Efficiency vs. Vin and load	11
Figure 16.	Static Vout regulation vs. Vin and load	11
Figure 17.	EVL6563S-400W inductor current ripple envelope at 115 Vac, 60 Hz, full load.	12
Figure 18.	EVL6563S-400W inductor current ripple (detail) at 115 Vac, 60 Hz, full load	12
Figure 19.	EVL6563S-400W inductor current ripple envelope at 230 Vac, 50 Hz, full load.	13
Figure 20.	EVL6563S-400W inductor current ripple (detail) at 230 Vac, 50 Hz, full load	13
Figure 21.	EVL6563S-400W input current shape at 100 Vac, 60 Hz, CFF = 470 nF, RFF = 390 k Ω .	15
Figure 22.	EVL6563S-400W input current shape at 100 Vac, 60 Hz, CFF = 1.5 μ F, RFF = 390 k Ω	15
Figure 23.	EVL6563S-400W input mains surge from 90 Vac to 140 Vac, full load, CFF = 1 μ F	16
Figure 24.	L6562A FOT input mains surge from 90 Vac to 140 Vac, full load, NO VFF input.	16
Figure 25.	EVL6563S-400W input mains dip from 140 to 90 Vac, full load, CFF = 1 μ F	17
Figure 26.	L6562A FOT input mains dip from 140 to 90 Vac, full load, NO VFF input	17
Figure 27.	EVL6563S-400W start-up at 90 Vac, 60 Hz, full load.	18
Figure 28.	EVL6563S-400W start-up at 265 Vac, 50 Hz, full load.	18
Figure 29.	EVL6563S-400W start-up attempt at 80 Vac, 60 Hz, full load	19
Figure 30.	EVL6563S-400W start-up with slow input voltage increase - full load	20
Figure 31.	EVL6563S-400W turn-off with slow input voltage decrease - full load	20
Figure 32.	EVL6563S-400W start-up at 265 V, 50 Hz, 30 mA load.	21
Figure 33.	EVL6563S-400W start-up at 265 V, 50 Hz, no load and with external Vcc	21
Figure 34.	EVL6563S-400W open loop at 115 Vac, 60 Hz, full load	23
Figure 35.	On/Off control by a cascaded converter controller via PFC_OK or RUN pin	24
Figure 36.	Interface circuits that let the L6563S switch a PWM controller on or off.	25
Figure 37.	EVL6563S-400W PCB layout (not 1:1 scaled)	27
Figure 38.	Thermal map at 115 Vac, 60 Hz - full load	29
Figure 39.	Thermal map at 230 Vac, 50 Hz - full load	29
Figure 40.	115 Vac and full load - phase	30
Figure 41.	115 Vac and full load - neutral	30
Figure 42.	230 Vac and full load - phase	30
Figure 43.	230 Vac and full load - neutral	30
Figure 44.	Electrical diagram	34
Figure 45.	Side view of pin.	35

List of tables

Table 1.	Measured temperature at 115 Vac and 230 Vac - full load	29
Table 2.	Bill of materials for the EVL6563S-400W demonstration board	31
Table 3.	Winding characteristics	34
Table 4.	Document revision history	37

1 Main characteristics and circuit description

The EVL6563S-400W demonstration board has the following characteristics.

- Line voltage range: 90 to 265 Vac
- Minimum line frequency (f_L): 47 Hz
- Regulated output voltage: 400 V
- Rated output power: 400 W
- Maximum $2f_L$ output voltage ripple: 10 V pk-pk
- Hold-up time: 22 ms (V_{DROD} after hold-up time: 300 V)
- Maximum switching frequency: 85 kHz ($V_{in} = 90$ Vac, $P_{out} = 400$ W)
- Minimum estimated efficiency: 90% ($V_{in} = 90$ Vac, $P_{out} = 400$ W)
- Maximum ambient temperature: 50 °C
- EMI: in accordance with EN55022 Class-B
- PCB type and size: single side, 70 μ m, CEM-1, 148.5 x 132 mm
- Low profile design: 35 mm component maximum height

The demonstration board implements a power factor correction (PFC) pre-regulator delivering 400 W of continuous power on a regulated 400 V rail from a wide-range mains voltage, and providing for the reduction of the mains harmonics, thus complying with the European norm EN61000-3-2 and the Japanese norm JEITA-MITI. This rail will be the input for the cascaded isolated DC-DC converter that will provide the output voltages required by the load.

The board is equipped with enough heat sinking to allow full-load operation in still air. With an appropriate airflow and without any change in the circuit, the demonstration board can easily deliver up to 450 W.

The controller is the L6563S (U1), integrating all the functions needed to control the PFC stage and to interface with the downstream converter. The L6563S controller chip is designed for transition-mode (TM) operation, where the boost inductor works next to the boundary between continuous (CCM) and discontinuous conduction mode (DCM). However, with a slightly different usage, the chip can operate so that the boost inductor works in CCM, hence surpassing the limitations of TM operation in terms of power handling capability. The gate-drive capability of the L6563S is also adequate to drive the MOSFETs used at higher power levels. This approach, which couples the simplicity and cost-effectiveness of TM operation with the high-current capability of CCM operation, is the fixed off time (FOT) control. The control modulates the ON time of the power switch, while its OFF time is kept constant. More precisely, the line-modulated FOT (LM FOT) is used, where the OFF time of the power switch is not rigorously constant but is modulated by the instantaneous mains voltage. Refer to [2] for a detailed description of this technique.

The power stage of the PFC is a conventional boost converter, connected to the output of the rectifier bridge D2. It includes the coil L4, the diode D3 and the capacitors C6 and C7. The boost switch is represented by the power MOSFETs Q1 and Q2. The NTC R2 limits the inrush current at switch on. It has been connected to the DC rail, in series to the output electrolytic capacitor, in order to improve the efficiency during low line operation. Additionally, the splitting into two of the output capacitors (C6 and C7) means that the AC current is mainly managed by the film capacitor C7, making the electrolytic cheaper because it only has to bear the DC part.

At start-up the L6563S is powered by the Vcc capacitor (C12) that is charged via the resistors R3 and R4, and then the L4 secondary winding (pins 8-11), and the charge pump circuit (R5, C10, D5 and D4) generates the Vcc voltage that powers the L6563S during normal operations.

The dividers R32, R33 and R34 provide the L6563S multiplier with information relating to the instantaneous voltage used to modulate the boost current. The same information is also used to obtain the average value of the AC line by the voltage feed-forward (V_{FF}) pin. The dividers R9, R10, R11, R12 and R13 are dedicated to sensing the output voltage while the dividers R6, R7, R8 and R24 are dedicated to protecting the circuit in case of voltage loop failures. The line-modulated FOT is obtained by the timing generator components D6, C15, R15, C16, R16, R31, Q3.

The board is equipped with an input EMI filter designed for a two-wire input mains plug. It is composed of two stages: a common-mode pi-filter connected at the input (C1, L1, C2, C3) and a differential-mode pi-filter after the input bridge (C4, L3, C5). It also offers the possibility of easily connecting a downstream converter and testing the interface signals managed by the L6563S.

2 Test results and significant waveforms

2.1 Harmonic content measurement

One of the main purposes of a PFC pre-conditioner is to correct the input current distortion, decreasing the harmonic contents below the limits of the relevant regulations. Therefore, the board has been tested according to the European rule EN61000-3-2 Class-D and Japanese rule JEITA-MITI Class-D, at full load and 70 W output power, at both the nominal input voltage mains.

As shown in the following figures, the circuit can reduce the harmonics well below the limits of both regulations from full load down to light load. An output power of 70 W has been chosen because it is almost the lower power limit at which the harmonics have to be limited according the mentioned rules.

Figure 3. EVL6563S-400W compliance to EN61000-3-2 Standard at full load

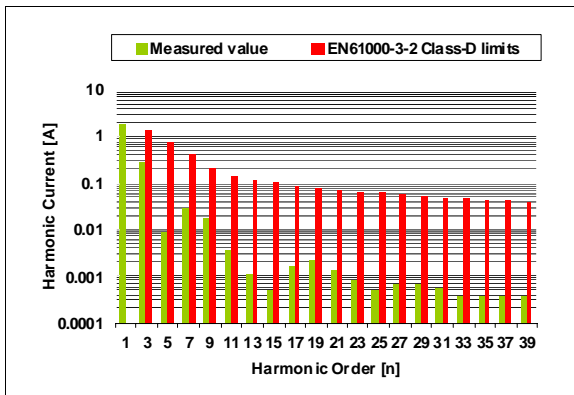

Figure 4. EVL6563S-400W compliance to JEITA-MITI Standard at full load

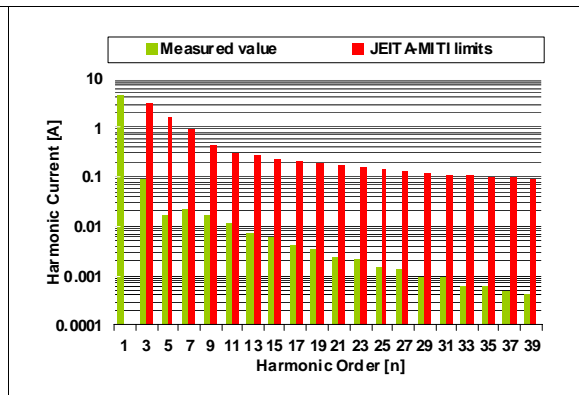

Figure 5. EVL6563S-400W compliance to EN61000-3-2 Standard at 70 W load

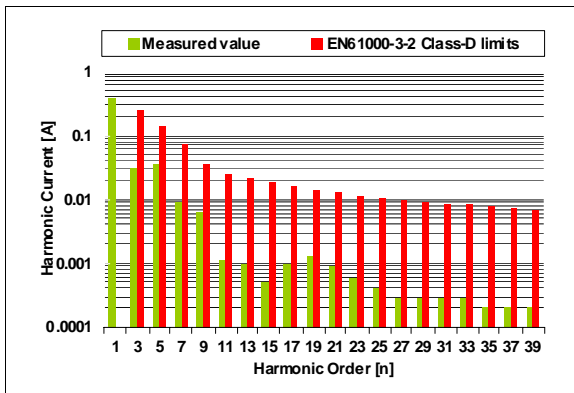
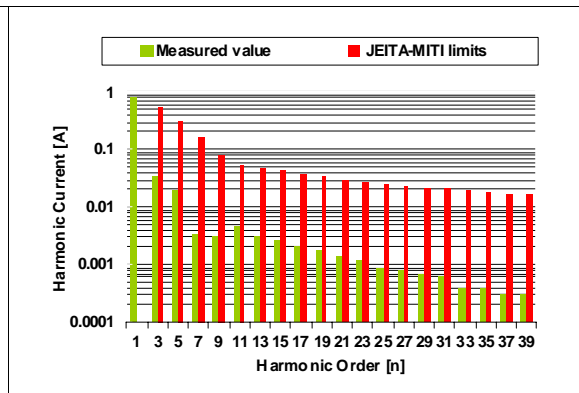

Figure 6. EVL6563S-400W compliance to JEITA-MITI Standard at 70 W load



For reference, the following waveforms show the input current and voltage at the nominal input voltage mains and at different load conditions.

Figure 7. EVL6563S-400W input current waveform at 100 V, 60 Hz, 400 W load

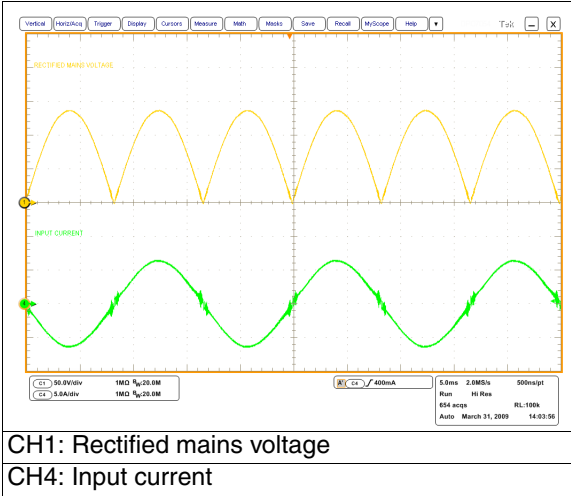

Figure 8. EVL6563S-400W input current waveform at 230 V, 50 Hz, 400 W load

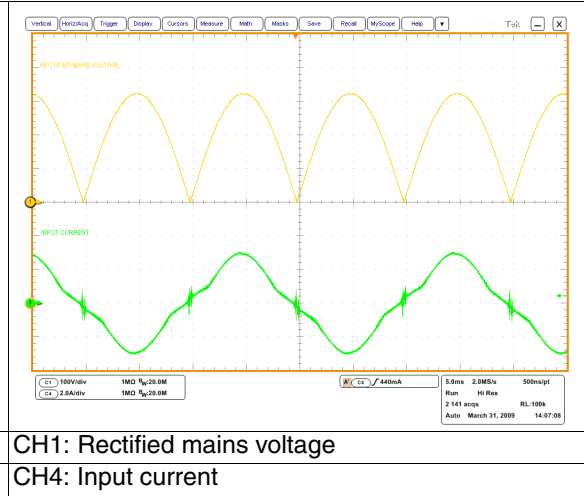

Figure 9. EVL6563S-400W input current waveform at 100 V, 60 Hz, 200 W load

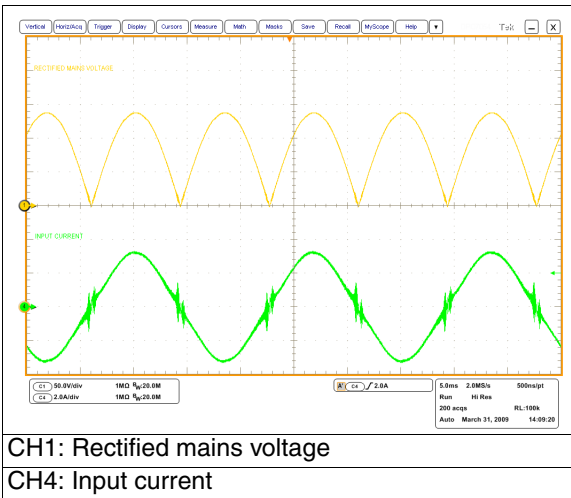

Figure 10. EVL6563S-400W input current waveform at 230 V, 50 Hz, 200 W load

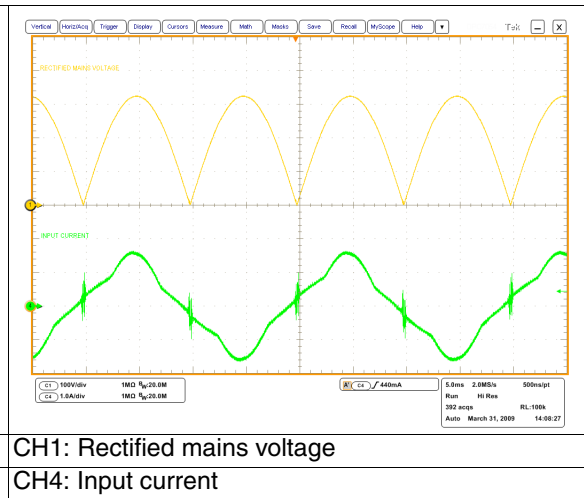

Figure 11. EVL6563S-400W input current waveform at 100 V, 60 Hz, 70 W load

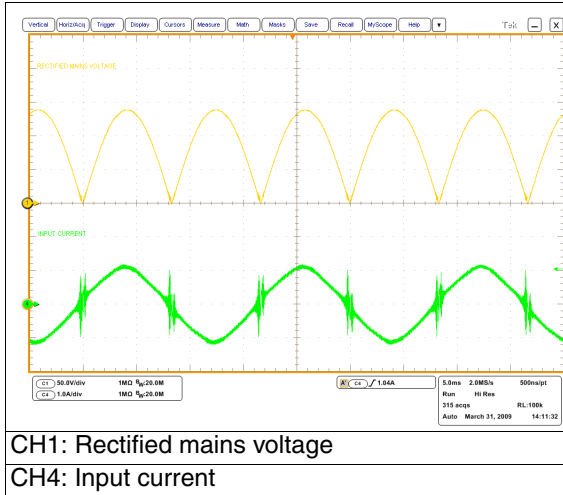
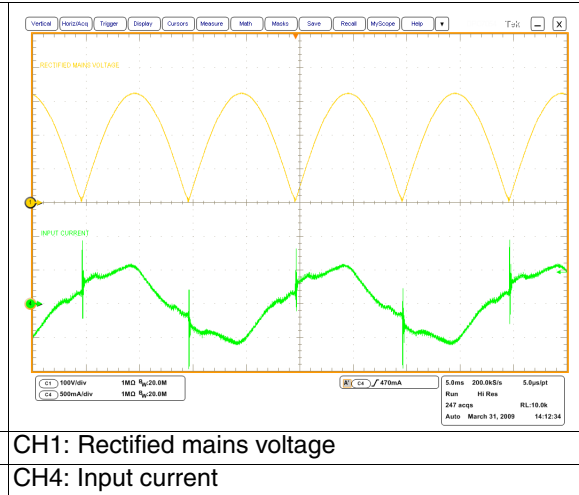

Figure 12. EVL6563S-400W input current waveform at 230 V, 50 Hz, 70 W load



The power factor (PF) and the total harmonic distortion (THD) have also been measured and the results are reported in [Figure 13](#) and [Figure 14](#). As shown, the PF at full load and half load remains close to unity throughout the input voltage mains range, while when the circuit is delivering 70 W it decreases at a high mains range. THD is low, remaining within 20% at the maximum input voltage.

Figure 13. Power factor vs. Vin and load

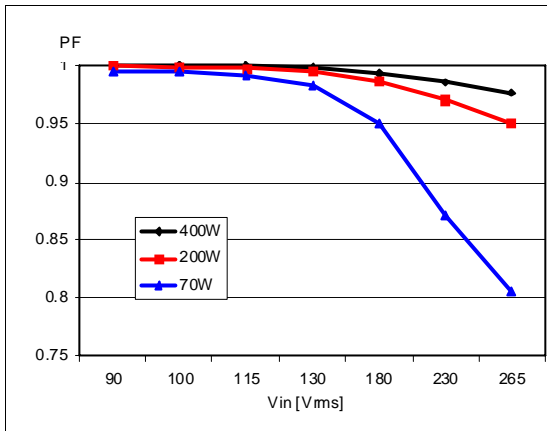
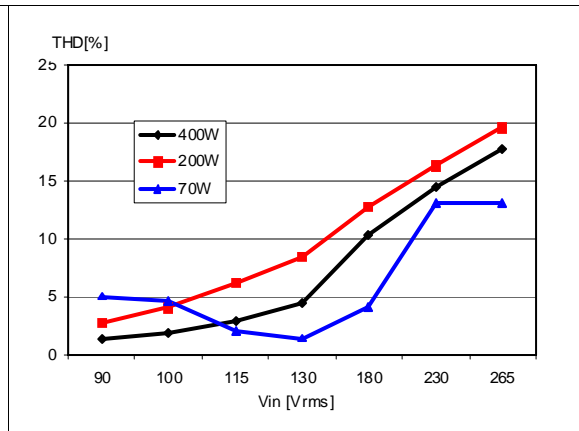

Figure 14. THD vs. Vin and load



The converter’s efficiency reported in [Figure 15](#) is very good at all load and line conditions. At full load, it is always significantly higher than 90%, making this design suitable for high-efficiency power supplies.

The measured output voltage variation at different line and load conditions is reported in [Figure 16](#). As shown, thanks to the voltage feed-forward function embedded in the L6563S, the voltage is perfectly stable over the entire input voltage range. At 265 Vac and light load, there is a negligible deviation of 1 V due to the intervention of the burst mode function.

Figure 15. Efficiency vs. Vin and load

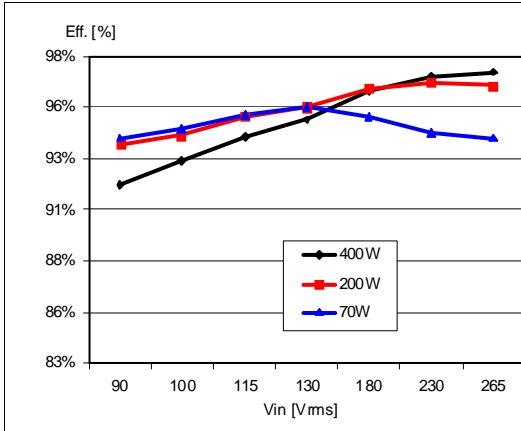
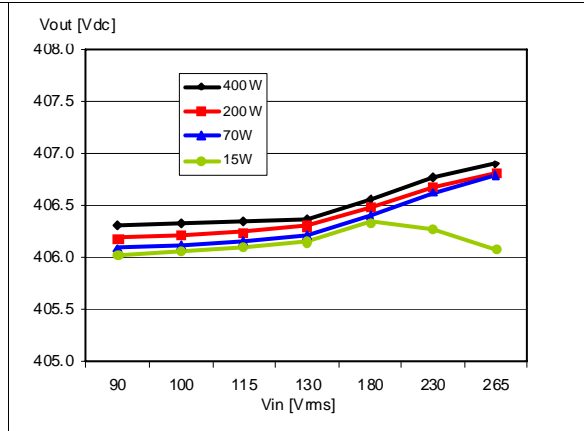

Figure 16. Static Vout regulation vs. Vin and load



2.2 Inductor current in FOT and L6563S THD optimizer

The following figures show the waveforms of the inductor current at different voltage mains: as shown in [Figure 17](#) and [Figure 19](#), the inductor current waveform over the half-period of a line is very similar to that of a CCM PFC. [Figure 18](#) and [Figure 20](#) (magnifications of the waveforms at the peak of the sine wave), show the different ripple currents and OFF times, which are modulated by the input mains voltage. It is also possible to note the transition angle from DCM to CCM, which occurs closer to the zero crossing of the current sine wave at low mains and moves towards the top if the circuit is working at high mains.

Figure 17. EVL6563S-400W inductor current ripple envelope at 115 Vac, 60 Hz, full load

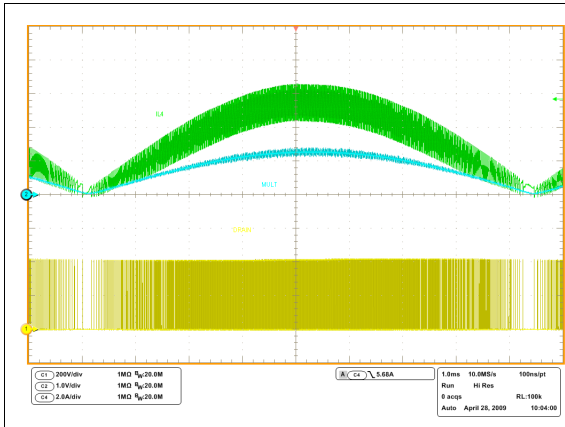

CH1: Q1/Q2 drain voltage
CH2: MULT voltage - pin #3
CH4: L4 inductor current ripple envelope

Figure 18. EVL6563S-400W inductor current ripple (detail) at 115 Vac, 60 Hz, full load

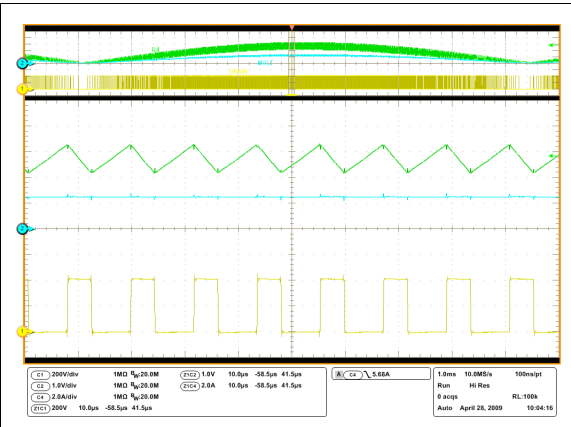

CH1: Q1/Q2 drain voltage
CH2: MULT voltage - pin #3
CH4: L4 inductor current ripple envelope

On both the drain voltage traces reported in [Figure 18](#) and [Figure 20](#), close to the zero crossing points of the sine wave it is possible to note the action of the THD optimizer embedded in the L6563S. This optimizer is a circuit that minimizes the conduction's dead-angle occurring at the AC's input current near the zero-crossings of the line voltage (crossover distortion). In this way, the THD of the current is considerably reduced. A major cause of this distortion is the inability of the system to transfer energy effectively when the instantaneous line voltage is very low. This effect is magnified by the high-frequency filter capacitor placed after the bridge rectifier, which retains some residual voltage that causes the diodes of the bridge rectifier to be reverse-biased and the input current flow to temporarily stop. To overcome this issue, the device forces the PFC pre-regulator to process more energy near the line voltage's zero-crossing, as compared to that commanded by the control loop.

This results in minimizing the time interval where energy transfer is lacking and fully discharging the high-frequency filter capacitor after the bridge. Essentially, the circuit artificially increases the ON time of the power switch with a positive offset added to the output of the multiplier in the proximity of the line voltage zero crossing. This offset is reduced as the instantaneous line voltage increases, so that it becomes negligible as the line voltage moves towards the top of the sinusoid, and it is modulated by the voltage on the V_{FF} pin so as to have little offset at low lines, where the transfer of energy at zero crossings is typically quite good, and a larger offset at high lines, where the energy transfer gets worse.

To get the maximum benefit from the THD optimizer circuit, the high-frequency filter capacitors after the bridge rectifier should be minimized, compatibly with EMI filtering needs. A large capacitance, in fact, introduces a conduction dead-angle of the AC input current in itself, thus reducing the effectiveness of the optimizer circuit.

Figure 19. EVL6563S-400W inductor current ripple envelope at 230 Vac, 50 Hz, full load

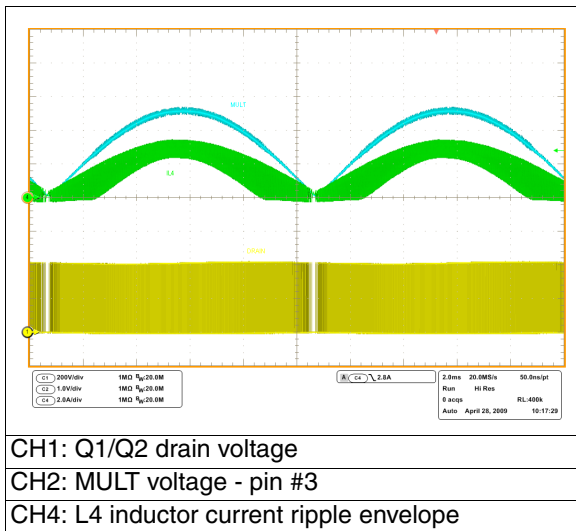
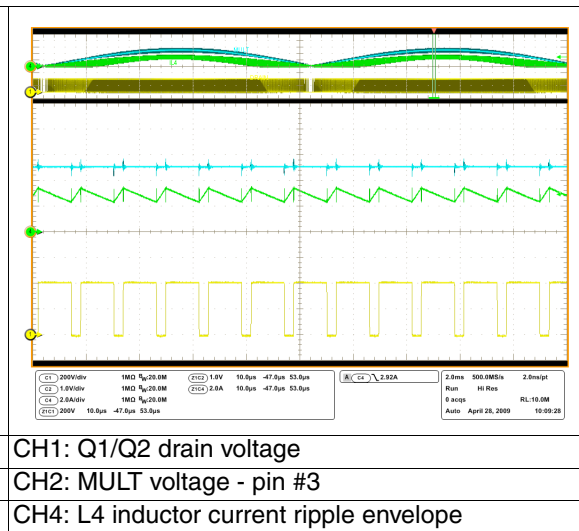

Figure 20. EVL6563S-400W inductor current ripple (detail) at 230 Vac, 50 Hz, full load



2.3 Voltage feed-forward

The power stage gain of PFC pre-regulators varies with the square of the RMS input voltage. So does the crossover frequency (f_c) of the overall open-loop gain because the gain has a single pole characteristic. This leads to large trade-offs in the design. For example, setting the gain of the error amplifier to get an f_c of 20 Hz at 264 Vac means having an f_c of 4 Hz at 88 Vac, resulting in sluggish control dynamics. Additionally, the slow control loop causes large transient current flows during rapid line or load changes that are limited by the dynamics of the multiplier output. This limit is considered when selecting the sense resistor to let the full load power pass under minimum line voltage conditions, with some margin. But a fixed current limit allows excessive power inputs at high lines, whereas a fixed power limit requires the current limit to vary inversely with the line voltage.

The voltage feed-forward function can compensate for the gain variation with the line voltage and allow overcoming all of the above-mentioned issues. It consists of deriving a voltage proportional to the input RMS voltage, feeding this voltage into a squarer/divider circuit ($1/V^2$ corrector) and providing the resulting signal to the multiplier that generates the current reference for the inner current-control loop. In this way, a change of the line voltage will cause an inversely proportional change of the half sine amplitude at the output of the multiplier so that the current reference is adapted to the new operating conditions with (ideally) no need for invoking the slow dynamics of the error amplifier. Additionally, the loop gain will be constant throughout the input voltage range, which significantly improves dynamic behavior at low lines and simplifies loop design.

The L6563S realizes a voltage feed-forward with a technique that makes use of just two external parts and that limits the feed-forward time constant trade-off issue to only one direction. A capacitor C_{FF} (C18) and a resistor R_{FF} ($R26 + R27$), both connected to the V_{FF} pin (5), complete an internal peak-holding circuit that provides a DC voltage equal to the peak of the rectified sine wave applied on the MULT pin (pin 3). R_{FF} provides a means of discharging C_{FF} when the line voltage decreases.

However, a drawback of the V_{FF} technique is an increase in the harmonics; in fact, deriving a voltage proportional to the RMS line voltage implies a form of integration, which has its own time constant. If it is too small, the voltage generated will be affected by a considerable amount of ripple at twice the mains frequency, thus causing a distortion of the current reference (resulting in high THD and poor PF). If it is too large, there will be a considerable delay in setting the right amount of feed forward, resulting in excessive overshoot and undershoot of the pre-regulator's output voltage in response to large line voltage changes. Clearly, a trade-off is required. For reference, [Figure 21](#) and [Figure 22](#) show a comparison of the input current shape and the measurement of the THD and 3RD harmonic amplitude for different C_{FF} values taken from a similar board using the former L6563.

Figure 21. EVL6563S-400W input current shape at 100 Vac, 60 Hz, $C_{FF} = 470 \text{ nF}$, $R_{FF} = 390 \text{ k}\Omega$

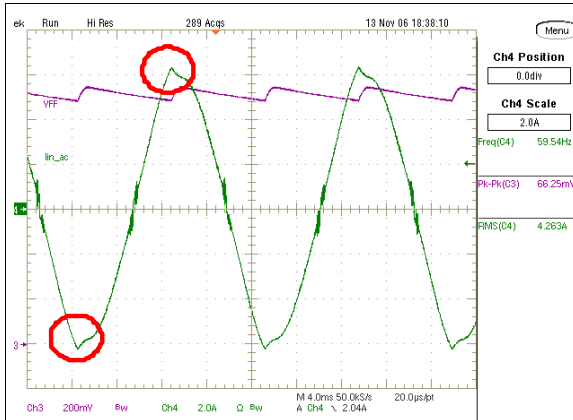

THD [%]: 3.39% - 3RD harmonic: 0.126 A

CH3: V_{FF} voltage - pin #5

CH4: Input current

Figure 22. EVL6563S-400W input current shape at 100 Vac, 60 Hz, $C_{FF} = 1.5 \mu\text{F}$, $R_{FF} = 390 \text{ k}\Omega$

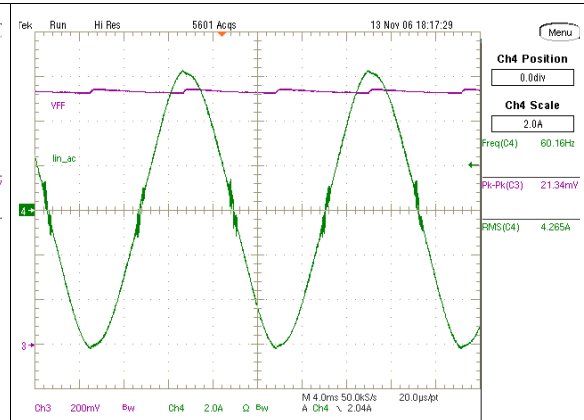

THD [%]: 2.75% - 3RD harmonic: 0.109 A

CH3: V_{FF} voltage - pin #5

CH4: Input current

To overcome this issue, the new L6563S integrates an innovative circuitry that allows getting a fast transient response regardless of the voltage change that occurs on the mains, both surges and drops. Therefore, if there is a sudden rise in the line voltage, C_{FF} is rapidly charged through the low impedance of the internal diode and no appreciable overshoot is visible at the pre-regulator's output. If there is a drop in the line voltage, an internal "mains drop" detector enables a low impedance switch that suddenly discharges C_{FF} , therefore avoiding a long settling time before reaching the new voltage level. Consequently, an acceptably low steady-state ripple and low current distortion can be achieved without any considerable undershoot or overshoot on the pre-regulator's output like in systems with no feed-forward compensation.

Figure 23 shows the behavior of the EVL6563S-400W demonstration board in the case of an input voltage surge from 90 to 140 Vac: in the graphic, it is evident that the V_{FF} function provides for the stability of the output voltage, which is not affected by the input voltage surge. In fact, thanks to the V_{FF} function, the compensation of the input voltage variation is very fast and the output voltage remains stable at its nominal value. The opposite is confirmed in *Figure 24*: it shows the behavior of a PFC using the L6562 operating in FOT and delivering a similar output power. In the case of a mains surge, the controller cannot compensate it and the output voltage stability is guaranteed by the feedback loop only. Unfortunately, as previously said, its bandwidth is narrow and thus the output voltage has a significant deviation from the nominal value. The circuit has the same behavior in the case of a mains surge at any input voltage, and is also not affected if the input mains surge happens at any point of the input sine wave.

Figure 23. EVL6563S-400W input mains surge from 90 Vac to 140 Vac, full load, $C_{FF} = 1 \mu F$

Figure 24. L6562A FOT input mains surge from 90 Vac to 140 Vac, full load, NO V_{FF} input

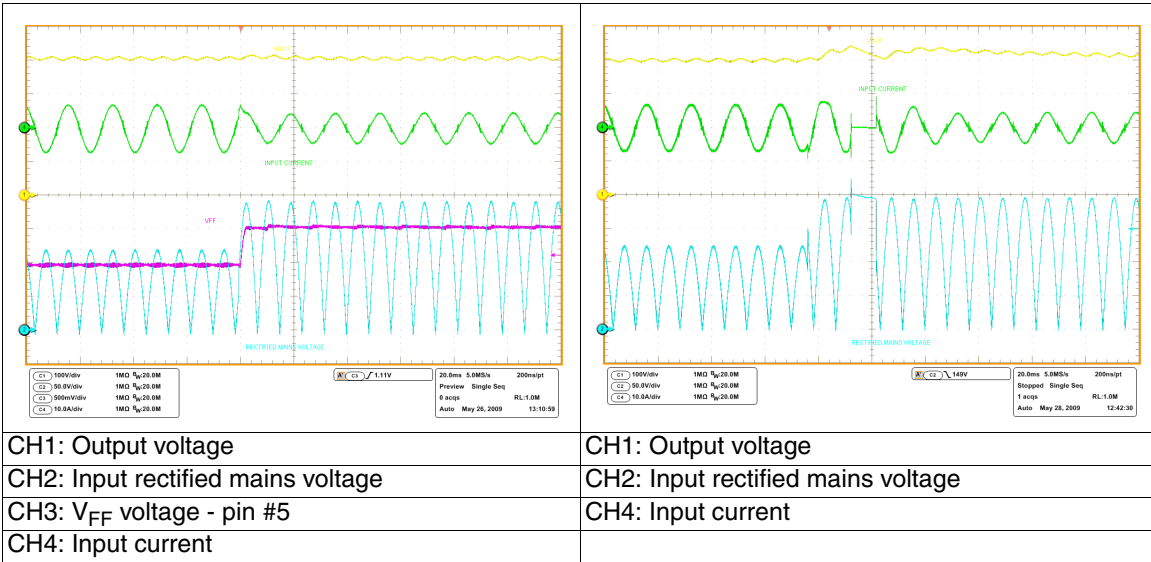
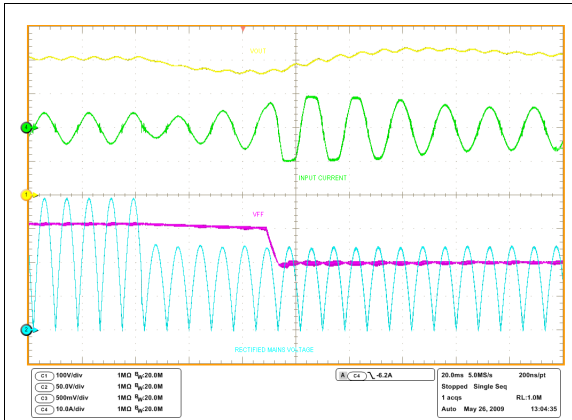

Figure 25 shows the circuit's behavior in the case of a mains dip: as previously described, the internal circuitry has detected the decreasing of the mains voltage and has activated the C_{FF} internal fast discharge. As you can see in this case, the output voltage changes but within a few mains cycles it comes back to the nominal value. The situation is different if we check the performance of a controller without the V_{FF} function. Figure 26 shows the behavior of a PFC using the L6562A operating in FOT and delivering a similar output power: in the case of a mains dip from 140 to 90 Vac, the output voltage variation is not very different but the output voltage requires a longer time to restore the original value.

Doing tests with a wider voltage variation (for example, 265 to 90 Vac) the output voltage variation of a PFC without the voltage feed-forward fast discharge is much more emphasized.

Figure 25. EVL6563S-400W input mains dip from 140 to 90 Vac, full load, $C_{FF} = 1 \mu F$



CH1: Output voltage
 CH2: Input rectified mains voltage
 CH3: V_{FF} voltage - pin #5
 CH4: Input current

Figure 26. L6562A FOT input mains dip from 140 to 90 Vac, full load, NO V_{FF} input

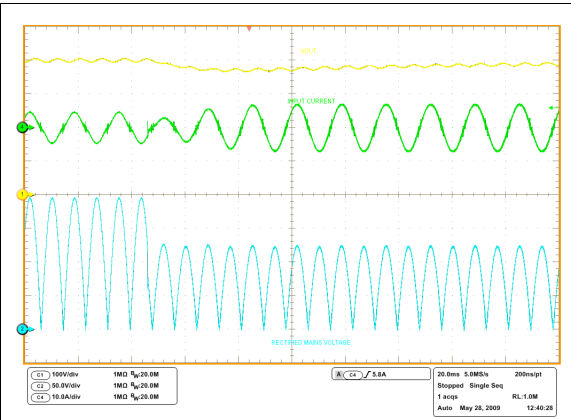

CH1: Output voltage
 CH2: Input rectified mains voltage
 CH4: Input current

If you compare [Figure 21](#) and [Figure 22](#) to [Figure 23](#) and [Figure 25](#), you can see that the input current of the last two figures is much better and the 3rd harmonic current distortion is not noticeable. This demonstrates the benefits of the new voltage feed-forward circuit integrated in the L6563S, allowing you to get a fast response to mains disturbances and a very low THD and high PF at the same time.

2.4 Start-up and RUN pin

Figure 27 and Figure 28 show the waveforms during the start-up of the circuit, at mains plug-in. The Vcc voltage rises up to the turn-on threshold, and the L6563S starts the operation. For a short time the energy is supplied by the Vcc capacitor, then the auxiliary winding and the charge pump circuit take over. At the same time, the output voltage rises from the peak value of the rectified mains to the nominal value of the PFC output voltage. The good phase margin of the compensation network allows a clean start-up, without any large overshoot.

Figure 27. EVL6563S-400W start-up at 90 Vac, 60 Hz, full load

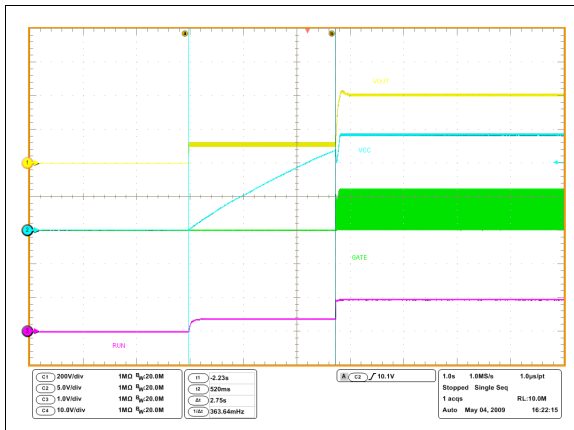

CH1: Output voltage
 CH2: Pin #14 - Vcc voltage
 CH3: Pin #10 - RUN
 CH4: Pin #13 - Gate drive

Figure 28. EVL6563S-400W start-up at 265 Vac, 50 Hz, full load

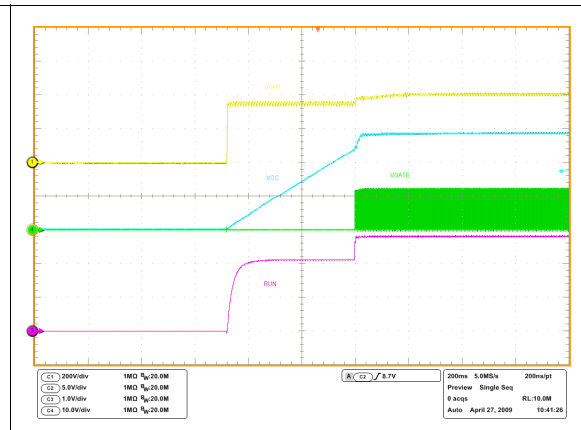

CH1: Output voltage
 CH2: Pin #14 - Vcc voltage
 CH3: Pin #10 - RUN
 CH4: Pin #13 - Gate drive

2.5 Brownout function

A dangerous event for any PFC is the operation during a mains undervoltage. This condition may cause overheating of the power section due to an excess of RMS current. To protect the PFC from this abnormal operation, a brownout protection is needed. It is basically a non-latched shutdown function that has to be activated when a mains undervoltage condition is detected.

The L6563S has a dedicated inhibit pin (RUN, #10) that embeds a comparator with hysteresis and which stops the L6563S operation if the voltage applied is below its threshold. Because the L6563S V_{FF} pin delivers a voltage signal proportional to the input mains, the complete brownout function can be easily realized using a simple resistor divider connected between the V_{FF} and RUN pins. In this demonstration board, the divider resistors setting the turn-on threshold are R26 and R27 on the schematic in [Figure 1](#). [Figure 29](#) shows a start-up tentative below the threshold. As visible at start-up, the RUN pin does not allow the PFC start-up.

Figure 29. EVL6563S-400W start-up attempt at 80 Vac, 60 Hz, full load

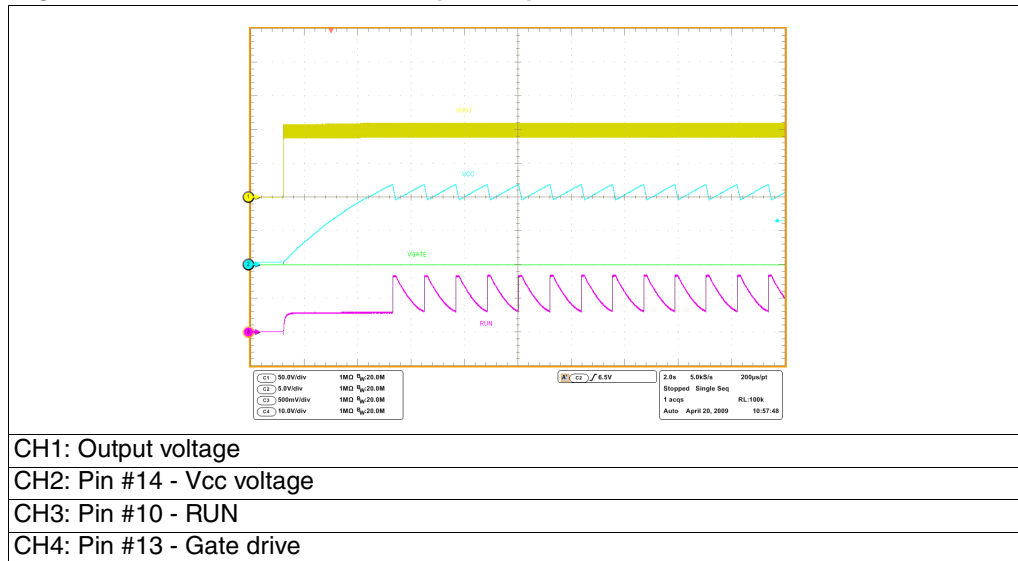

[Figure 30](#) and [Figure 31](#) show the waveforms of the circuit during operation of the brownout protection. In both cases, the mains voltages were increased or decreased slowly. As you can see, at both turn-on and turn-off, there are no bouncing or starting attempts by the converter.

Figure 30. EVL6563S-400W start-up with slow input voltage increase - full load

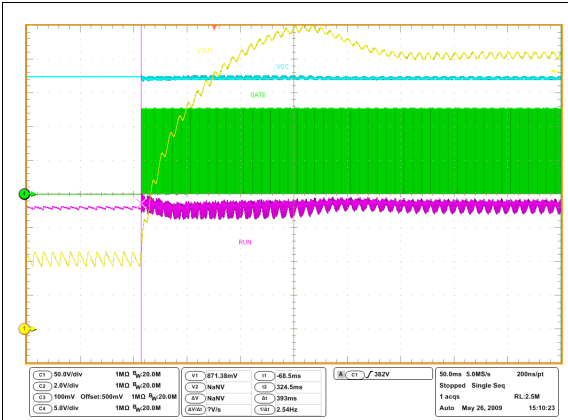

CH1: Output voltage
 CH2: Pin #14 - Vcc voltage
 CH3: Pin #10 - RUN
 CH4: Pin #13 - gate drive

Figure 31. EVL6563S-400W turn-off with slow input voltage decrease - full load

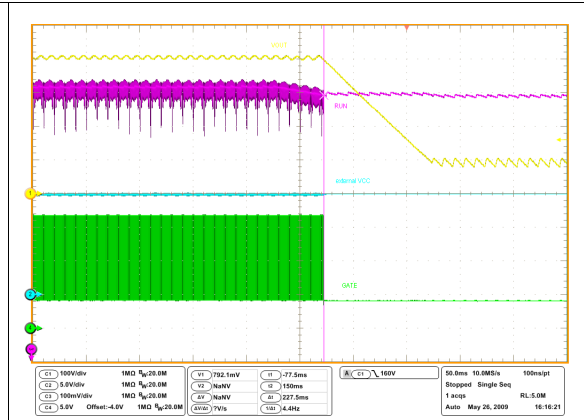

CH1: Output voltage
 CH2: Pin #14 - Vcc voltage
 CH3: Pin #10 - RUN
 CH4: Pin #13 - gate drive

2.6 Start-up at light loads

Figure 32. EVL6563S-400W start-up at 265 V, 50 Hz, 30 mA load

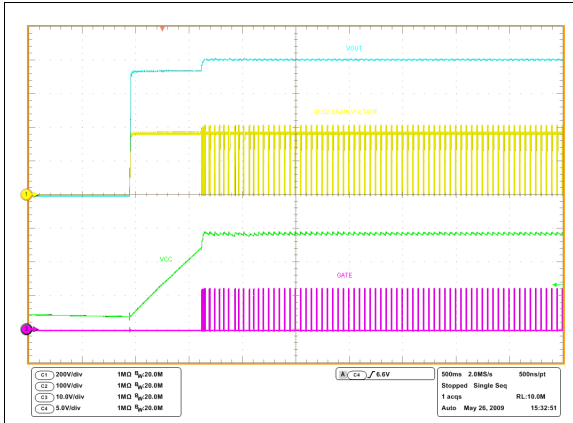

CH1: Q1/Q2 drain voltage

CH2: Output voltage

CH3: Pin #13 - gate drive

CH4: Pin #14 - Vcc voltage

Figure 33. EVL6563S-400W start-up at 265 V, 50 Hz, no load and with external Vcc

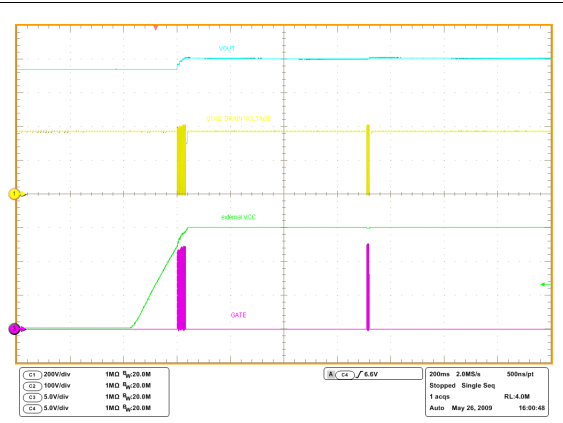

CH1: Q1/Q2 drain voltage

CH2: Output voltage

CH3: Pin #13 - gate drive

CH4: Pin #14 - Vcc voltage

The board, as it is, is able to properly handle an output load as low as 12 W. With lower load levels, the system will not start up correctly at high lines because burst pulses last so long that the Vcc voltage drops below the UVLO of the L6563S. In such conditions, if the load increases suddenly, the PFC output voltage will drop until the IC resumes normal operation. When the L6563S is supplied from an external source (typically, it is the auxiliary voltage that powers the controller of the downstream converter or an auxiliary power supply), the minimum load that can be handled properly goes to virtually zero. The start-up behavior at the minimum load (12 W) is reported in [Figure 32](#). It can be noted that the self-supply circuit connected to the auxiliary winding of the inductor is working properly.

[Figure 33](#) shows the circuit start-up at no load, with the L6563S powered by an external Vcc (15 V). The PFC regulates the output voltage perfectly.

2.7 Overvoltage and open-loop protection

Normally, the voltage-control loop keeps the output voltage V_o of the PFC pre-regulator close to its nominal value, set by the ratio of the resistors of the output divider (R9, R10, R11 and R12 in parallel to R13). The device's PFC_OK pin (#7) is dedicated to monitoring the output voltage with a separate resistor divider (R6, R7, R8 and R24). This divider has been selected so that the voltage at the pin reaches 2.5 V if the output voltage exceeds a preset value, usually higher than the maximum V_o that can be expected, also including worst-case load/line transients.

When this function is triggered, the activity of the gate drive is immediately stopped until the voltage on the PFC_OK pin drops below 2.4 V. Notice that R1, R2, R3 and R4 can be selected without any constraints.

The unique criterion is that both dividers have to sink a current from the output bus, which needs to be significantly higher than the current biasing the error amplifier and PFC_OK comparator.

The OVP function described above can handle "normal" overvoltage conditions, that is, those resulting from an abrupt load/line change or occurring at start-up. If the overvoltage is generated by a feedback disconnection, for instance, when the upper resistor of the output divider fails to open, an additional circuitry detects the voltage drop of the INV pin. If the voltage on pin INV is lower than 1.66 V and at the same time the OVP is active, the feedback failure is assumed. Hence, the gate drive activity is immediately stopped, the device is shut down, its quiescent consumption is reduced to below 180 μ A and the condition is latched as long as the supply voltage of the IC stays above the UVLO threshold. At the same time, the PWM_LATCH pin is asserted high. PWM_LATCH is an open-source output that can deliver 2.8 V minimum with a 0.25 mA load, intended for tripping a latched shutdown function of the PWM controller IC in the cascaded DC-DC converter, so that the entire unit is latched off. In this case, to resume operation, it is necessary to recycle the input power so that the V_{cc} voltage of the L6563S goes below 6 V and that one of the PWM controller goes below its UVLO threshold.

The PFC_OK pin doubles its function as a non-latched IC disable: a voltage below 0.23 V will shut down the IC, reducing its consumption to below 2 mA. In this case, both PWM_STOP and PWM_LATCH keep their high impedance status. To restart the IC, simply let the voltage at the pin go above 0.27 V.

Note that this function offers a complete protection against not only feedback loop failures or erroneous settings, but also against a failure of the protection itself. Either resistor of the PFC_OK divider failing short or open or a PFC_OK pin floating will result in the IC being shut down and the pre-regulator stopped.

The event of an open loop is captured in [Figure 34](#), where you can see the protection intervention stopping the operation of the L6563S and the activation of the PWM_LATCH pin.

Figure 34. EVL6563S-400W open loop at 115 Vac,60 Hz, full load

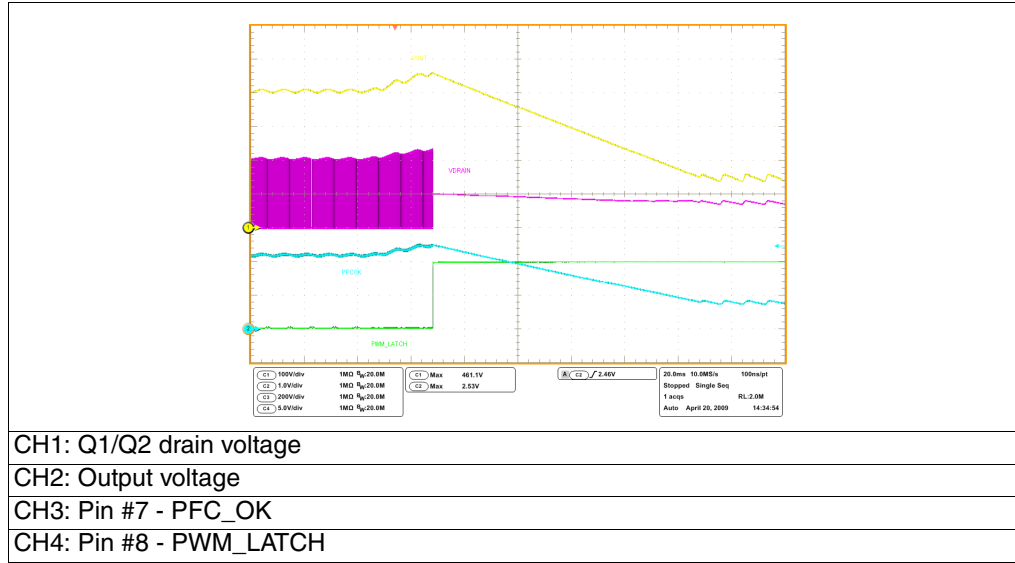

CH1: Q1/Q2 drain voltage

CH2: Output voltage

CH3: Pin #7 - PFC_OK

CH4: Pin #8 - PWM_LATCH

Figure 36. Interface circuits that let the L6563S switch a PWM controller on or off

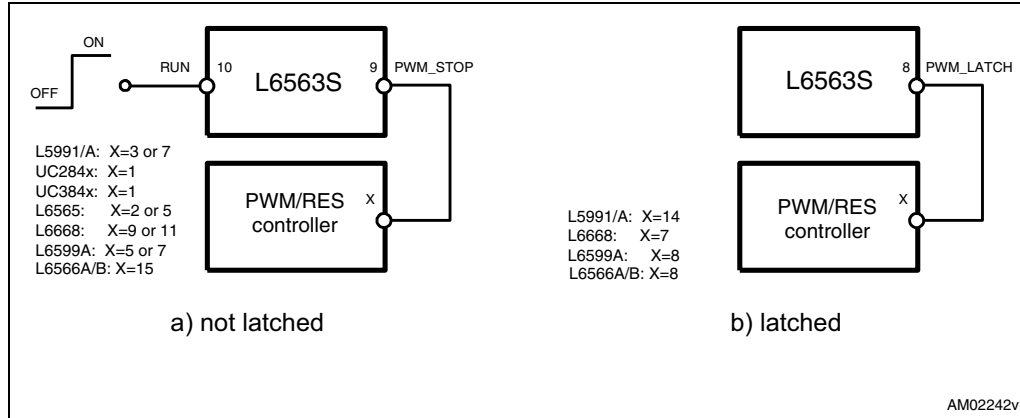

3 Layout hints

The layout of any converter is a very important phase in the design process that sometimes does not get the required attention by engineers. Even if the layout phase is sometimes time-consuming, a good layout saves time during the functional debugging and qualification phases. Additionally, a power supply circuit with a correct layout needs smaller EMI filters or less filter stages and therefore contributes to money saving.

The L6563S does not require any specific attention to the layout. General layout rules for any power converter have to be applied carefully. These basic rules are listed below, taking the EVL6563S-400W schematic as reference. They can be used for other PFC circuits with any power level, working either in FOT or TM control mode.

1. Keep the power and signal RTN separate. Connect the return pins of the component carrying the high current, such as the C4, C5 input filter, sense resistors, C6 and C7 output capacitor, as close as possible. This point will be the RTN's start point. A downstream converter will have to be connected to this return point.
2. Minimize the length of the traces relevant to L3, boost inductor L4, MOSFET drain, boost rectifier D4 and output capacitors C6 and C7.
3. Keep signal components as close as possible to each relevant pin of the L6563S. Keep the tracks relevant to pin #1 (INV) as short as possible. Components and traces relevant to the error amplifier have to be placed far from traces and connections carrying signals with high dv/dt like the MOSFET drains (Q1 and Q2).
4. Connect heat sinks to the power GND.
5. Add an external shield to the boost inductor and connect it to the power GND.
6. Connect the RTN of the signal components, including the feedback, PFC_OK and MULT dividers, close to the L6563S' pin #12 (GND).
7. Connect a ceramic capacitor (100÷470 nF) to pin #14 (Vcc) and to pin #12 (GND), close to the L6563S. Connect this point to the RTN's start point (see 1).

Figure 37. EVL6563S-400W PCB layout (not 1:1 scaled)

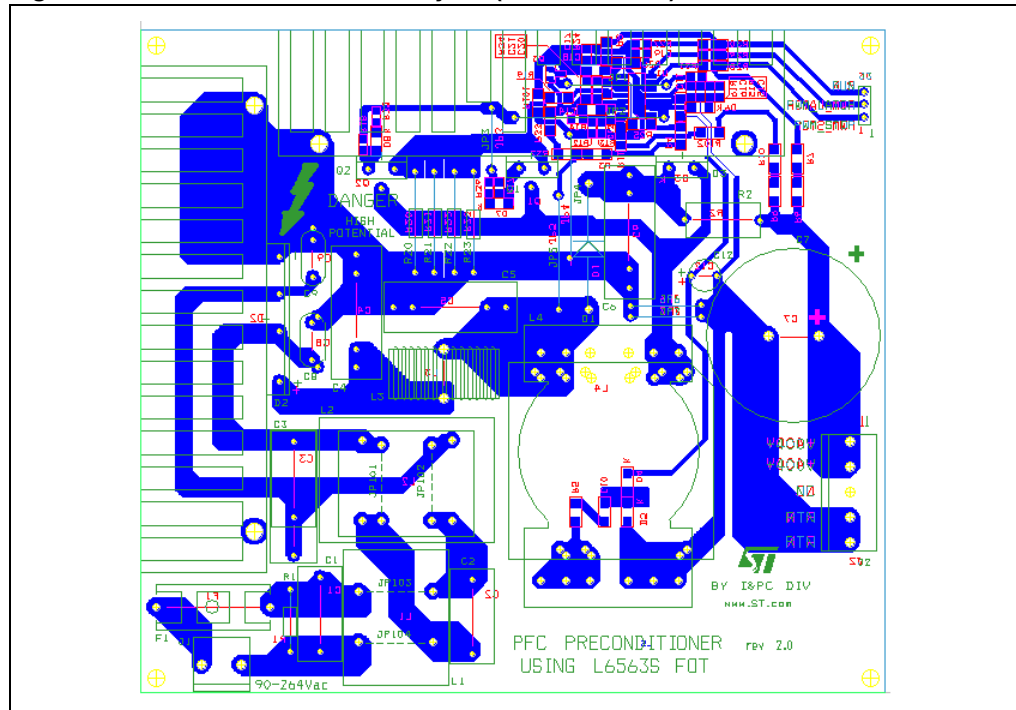

4 Audible noise

Differential mode currents in a circuit with high- and low-frequency components (like in a PFC) may produce audible noise due to inter-modulation between the operating frequency and the mains line frequency.

This phenomenon occurs because of the mechanical vibration of reactive components like capacitors and inductors. Current flowing in the winding can cause the vibration of wires or ferrite, and as such produce buzzing noise. To avoid this, the boost and filter inductors have to be wound with a correct wire tension and the component has to be varnished or dipped. Frequently, X-capacitors and filter capacitors after the bridge generate acoustic noise because of AC current that causes the electrodes to vibrate, producing buzzing noise. Thus, minimizing the AC current by inserting a differential-mode, Pi filter between the bridge and the boost inductor helps to reduce the acoustic noise. The EMI filter will also benefit from this. In fact, such a filter significantly decreases the ripple current that otherwise has to be filtered by the EMI filter. The capacitors to be selected are of a polypropylene (preferably dipped) type because boxed ones are generally more at risk of generating acoustic noise.

5 Thermal measures

To verify the reliability of the design, a thermal mapping by means of an IR camera has been done. *Figure 38* and *Figure 39* show the thermal measurements on the board component side at nominal input voltages and full load. Pointers (visible on the images) placed across the key components show the relevant temperature. *Table 1* provides the correlation between the measured points and the components, for both thermal maps. The ambient temperature during both measurements was 27°C. According to the results obtained, all the board components are operating within their temperature limits.

Figure 38. Thermal map at 115 Vac, 60 Hz - full load

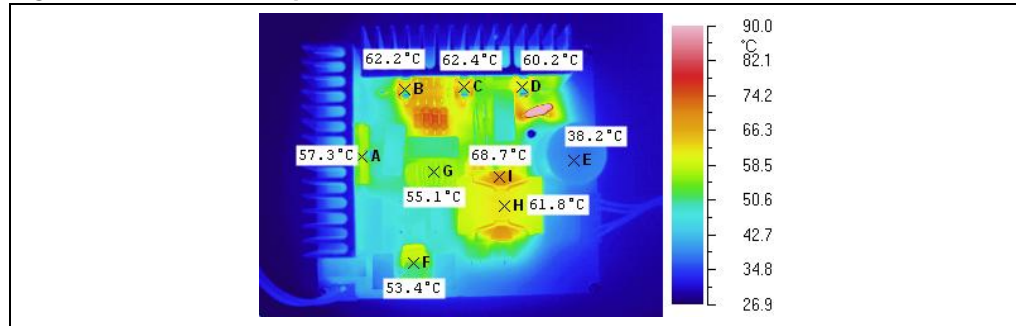

Figure 39. Thermal map at 230 Vac, 50 Hz - full load

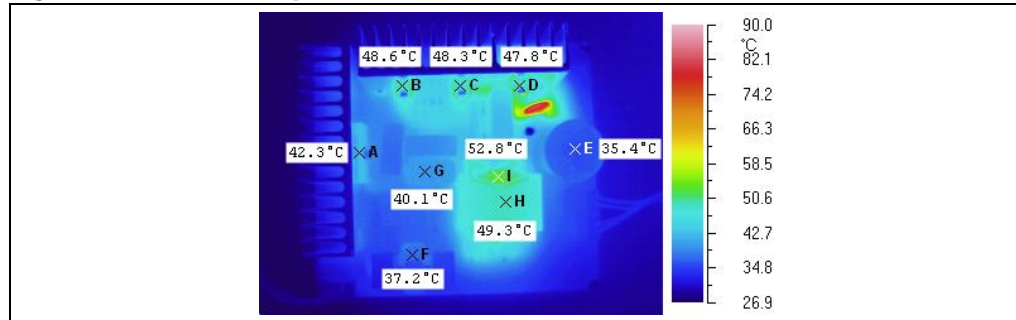

Table 1. Measured temperature at 115 Vac and 230 Vac - full load

Point	Component	Temperature at 115 Vac	Temperature at 230 Vac
A	D2	57.3 °C	42.3 °C
B	Q2	62.2 °C	48.6 °C
C	Q1	62.4 °C	48.3 °C
D	D3	60.2 °C	47.8 °C
E	C7	38.2 °C	35.4 °C
F	L1	53.4 °C	37.2 °C
G	L3	55.1 °C	40.1 °C
H	L4 – CORE	61.8 °C	49.3 °C
I	L4 – WINDING	68.7 °C	52.8 °C

6 Conducted emissions pre-compliance tests peak detection

The following figures show the peak measurement of the conducted noise at full load and nominal mains voltages. The limits shown on the diagrams are relevant to the EN55022 Class-B, the most popular norm for domestic equipment using a two-wire mains connection. As shown, a good margin of the measures with respect to the limits is achieved in all test conditions.

Figure 40. 115 Vac and full load - phase

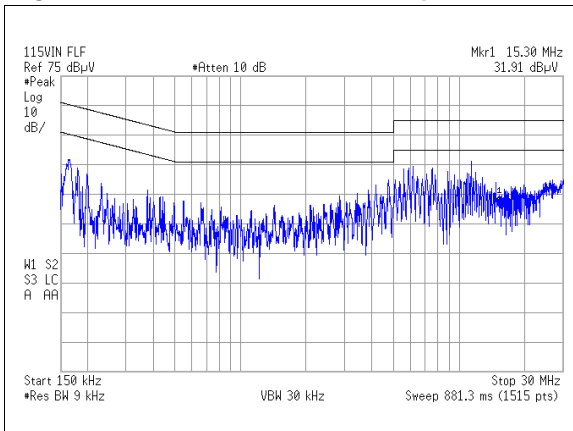

Figure 41. 115 Vac and full load - neutral

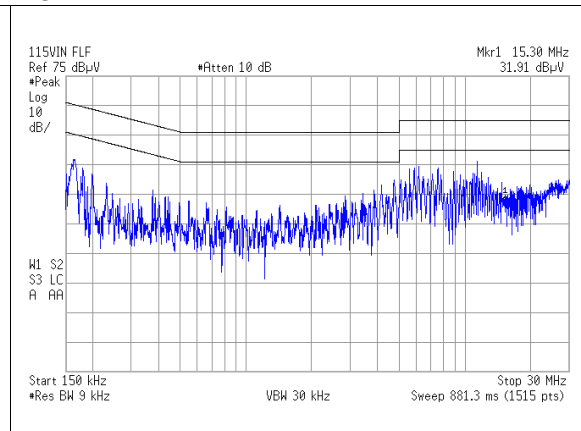

Figure 42. 230 Vac and full load - phase

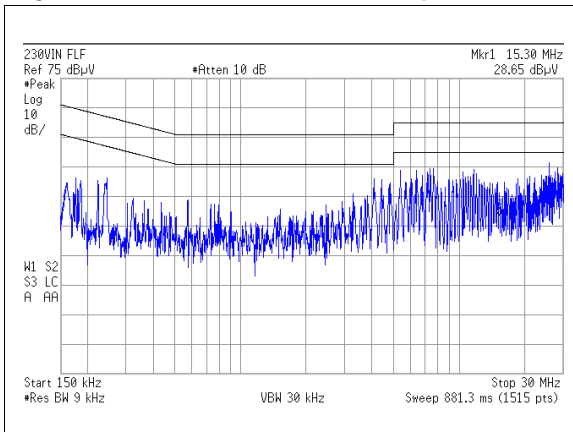
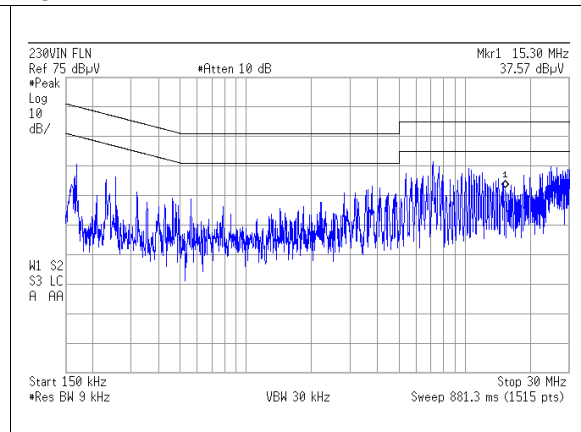

Figure 43. 230 Vac and full load - neutral



7 Bill of materials

Table 2. Bill of materials for the EVL6563S-400W demonstration board

Ref. Des.	Part type/part value	Case/package	Description	Supplier
C1	470 nF - X2	DWG	X2 film capacitor R46-I 3470--M1-	Arcotronics
C10	18N	1206	100 V SMD cericap - general-purpose	AVX
C11	470 nF/50 V	1206	50 V SMD cericap - general-purpose	AVX
C12	68 uF/50 V	DIA6.3X11	Aluminium elcap - FC series - 105 °C	Panasonic
C13	100 nF	0805	50 V SMD cericap - general-purpose	AVX
C14	1 uF	1206	50 V SMD cericap - general-purpose	AVX
C15	100 pF	0805	50 V SMD cericap - general-purpose	AVX
C16	220 pF	0805	50 V SMD cericap - general-purpose	AVX
C17	10 nF	0805	50 V SMD cericap - general-purpose	AVX
C18	1 uF	1206	25 V SMD cericap - general-purpose	AVX
C19	2 nF 2	0805	50 V SMD cericap - general-purpose	AVX
C2	470 nF - X2	DWG	X2 film capacitor R46-I 3470--M1-	Arcotronics
C20	330 pF	0805	50 V smd cericap - general-purpose	AVX
C21	10 nF	1206	50 V smd cericap - general-purpose	AVX
C3	680 nF - X2	DWG	X2 film capacitor R46-I 3680--M1-	Arcotronics
C4	470 nF - 630 V	DWG	Film capacitor MKP - B32653A6474J	EPCOS
C5	470 nF - 630 V	DWG	Film capacitor MKP - B32653A6474J	EPCOS
C6	470 nF - 630 V	DWG	Film capacitor MKP - B32653A6474J	EPCOS
C7	330 uF - 450 V	DIA35x35	Aluminium elcap - LLS series - 85 °C	Nichicon
D1	1N5406	DO-201	STD recovery rectifier	Vishay
D2	D15XB60	DWG	Rectifier bridge	Shindengen
D3	STTH8R06	TO-220FP	Ultrafast high voltage rectifier	STMicroelectronics
D4	LL4148	MINIMELF	Fast switching diode	VISHAY
D5	BZX85-C15	MINIMELF	Zener diode	VISHAY
D6	LL4148	MINIMELF	Fast switching diode	VISHAY
D7	LL4148	MINIMELF	Fast switching diode	VISHAY
D8	LL4148	MINIMELF	Fast switching diode	VISHAY
F1	8 A/250 V	5x20MM	8 A mains input fuse	Wickmann
J1			3-pin conn. (central rem.) P 3.96 KK series	Molex
J2			5-pin conn. (central rem.) P 3.96 KK series	Molex
JP101	Jumper		Wire jumper	

Table 2. Bill of materials for the EVL6563S-400W demonstration board (continued)

Ref. Des.	Part type/ Part value	Case/ package	Description	Supplier
JP102	JUMPER		Wire jumper	
L1	1.5 mH - 5 A	DWG	CM choke - LFR2205B	Delta electronics
L3	DM - 51 uH - 6 A	DWG	Filter inductor - LSR2306-1	Delta electronics
L4	PQ40 - 500 uH	DWG	PFC inductor - 86H-5410B	Delta electronics
Q1	STP12NM50FP	TO-220FP	N-channel power MOSFET	STMicroelectronics
Q2	STP12NM50FP	TO-220FP	N-channel power MOSFET	STMicroelectronics
Q3	BC857C	SOT-23	Small signal BJT - PNP	Vishay
R1	1M5	AXIAL	HV resistor	BC components
R10	680k	1206	SMD STD film res - 1% - 250 ppm/°C	BC components
R11	680k	1206	SMD STD film res - 1% - 250 ppm/°C	BC components
R12	82K	0805	SMD STD film res - 1% - 250 ppm/°C	BC components
R13	15k	0805	SMD STD film res - 1% - 250 ppm/°C	BC components
R14	56k	0805	SMD STD film res - 5% - 250 ppm/°C	BC components
R15	3K3	0805	SMD STD film res - 1% - 100 ppm/°C	BC components
R16	15K	0805	SMD STD film res - 1% - 100 ppm/°C	BC components
R17	6R8	0805	SMD STD film res - 5% - 250 ppm/°C	BC components
R18	6R8	0805	SMD STD film res - 5% - 250 ppm/°C	BC components
R19	1K0	1206	SMD STD film res - 5% - 250 ppm/°C	BC components
R2	NTC 2R5-S237	DWG	NTC resistor 2R5 S237	EPCOS
R20	0R39 - 1 W	AXIAL	Axial res - 5% - 250ppm/°C	BC components
R21	0R39 - 1 W	AXIAL	Axial res - 5% - 250 ppm/°C	BC components
R22	0R39 - 1 W	AXIAL	Axial res - 5% - 250 ppm/°C	BC components
R23	0R39 - 1 W	AXIAL	Axial res - 5% - 250 ppm/°C	BC components
R24	36k	0805	SMD STD film res - 5% - 250 ppm/°C	BC components
R26	56k	1206	SMD STD film res - 1% - 250 ppm/°C	BC components
R27	1M0	0805	SMD STD film res - 1% - 100 ppm/°C	BC components
R3	150K	1206	SMD STD film res - 5% - 250 ppm/°C	BC components
R31	1k5	0805	SMD STD film res - 1% - 100 ppm/°C	BC components
R32	620k	1206	SMD STD film res - 5% - 250 ppm/°C	BC components
R33	620k	1206	SMD STD film res - 5% - 250 ppm/°C	BC components
R34	10k	1206	SMD STD film res - 5% - 250 ppm/°C	BC components
R35	3R9	0805	SMD STD film res - 5% - 250 ppm/°C	BC components
R36	3R9	0805	SMD STD film res - 5% - 250 ppm/°C	BC components
R4	150K	1206	SMD STD film res - 5% - 250 ppm/°C	BC components

Table 2. Bill of materials for the EVL6563S-400W demonstration board (continued)

Ref. Des.	Part type/ Part value	Case/ package	Description	Supplier
R5	47R	1206	SMD STD film res - 5% - 250 ppm/°C	BC components
R6	2M2	1206	SMD STD film res - 5% - 250 ppm/°C	BC components
R7	2M2	1206	SMD STD film res - 5% - 250 ppm/°C	BC components
R8	2M2	1206	SMD STD film res - 5% - 250 ppm/°C	BC components
R9	680k	1206	SMD STD film res - 1% - 250 ppm/°C	BC components
R101	0R0	1206	SMD STD film res - 5% - 250 ppm/°C	BC components
R102	0R0	1206	SMD STD film res - 5% - 250 ppm/°C	BC components
U1	L6563S	SO-14	ENHANCED TM PFC CONTROLLER	STMicroelectronics

8 PFC coil specification

8.1 General description and characteristics

- Application types: consumer, home appliances
- Inductor type: open
- Coil former: vertical type, 6 + 6 pins
- Maximum temperature rise: 45 °C
- Maximum operating ambient temperature: 60 °C

8.2 Electrical characteristics

- Converter topology: boost PFC pre-regulator, FOT control
- Core type: PQ40-30 material grade PC44 or equivalent
- Maximum operating frequency: 100 kHz
- Primary inductance: 500 H 10% at 1 kHz - 0.25 V ^(a)
- Primary RMS current 4.75 A

Figure 44. Electrical diagram

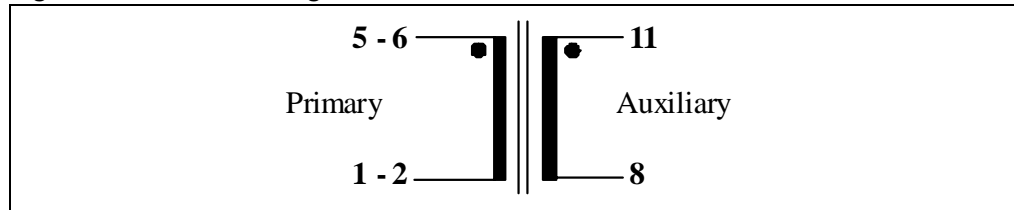

Table 3. Winding characteristics

Start pins	End pins	Number of turns	Wire type	Wire diameter	Notes
11	8	5 (spaced)	Single	0.28Ø	Bottom
5 - 6	1 - 2	65	Multistrand – G2	Litz 0.2Ø x 30	Top

a. Measured between pins 1-2 and 5-6.

8.3 Mechanical aspects and pin numbering

- Maximum height from PCB: 31 mm
- Ferrite: two symmetrical half cores, PQ40-30
- Material grade: PC44 or equivalent
- Central leg air gap: to be defined, in order to get the required inductance value
- Coil former type: vertical, 6 + 6 pins
- Pin distance: 5 mm
- Row distance: 45.5 mm
- Cut pins: 9 - 12
- External copper shield: not insulated (for EMI reasons), connected to pin 11 (GND)

Figure 45. Side view of pin

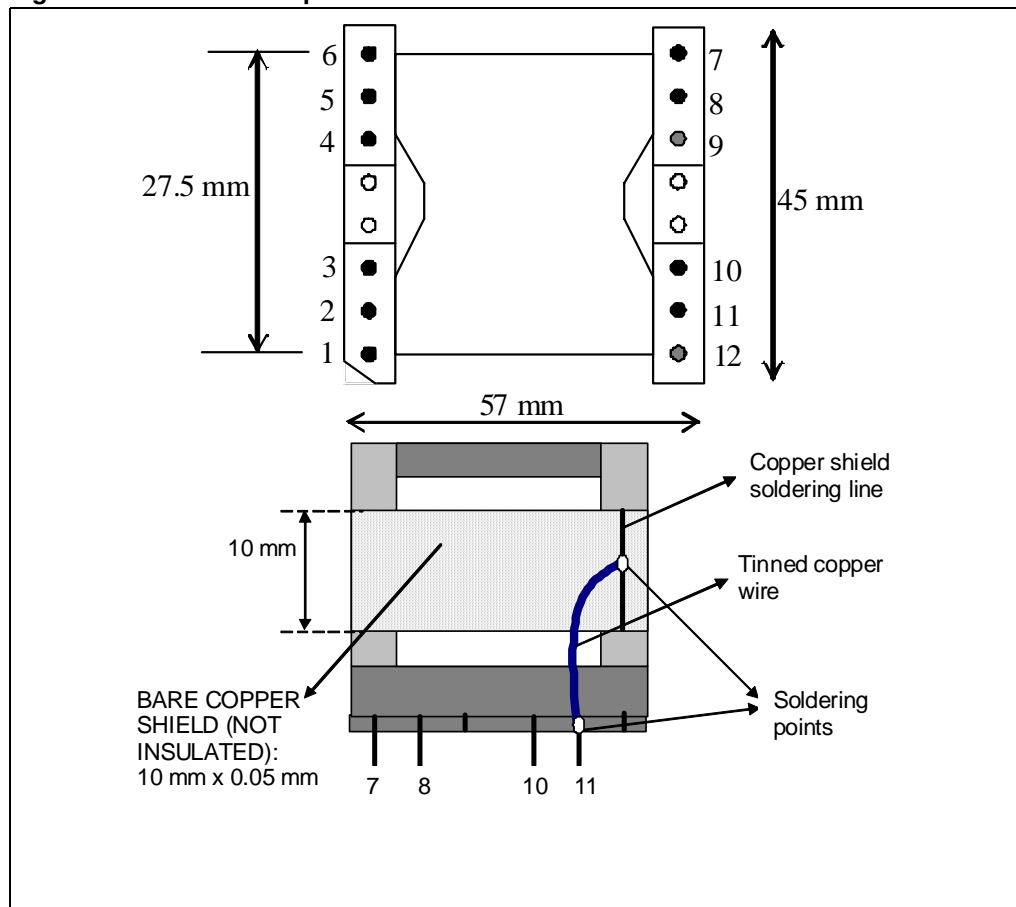

- Manufacturer: Delta electronics
- P/N: 86H-5410B

9 References

1. "L6563S enhanced transition-mode PFC controller", datasheet.
2. "Design of fixed-off-time controlled PFC pre-regulators with the L6562", AN1792.
3. "How to design a transition mode PFC pre-regulator with the new L6562A", AN2761.
4. "Design of 400 W fixed-off-time controlled PFC pre-regulator with the new L6562A", AN2782.

10 Revision history

Table 4. Document revision history

Date	Revision	Changes
20-Apr-2010	1	Initial release.
30-Nov-2010	2	Updated: Section 2.7 on page 22

Please Read Carefully:

Information in this document is provided solely in connection with ST products. STMicroelectronics NV and its subsidiaries ("ST") reserve the right to make changes, corrections, modifications or improvements, to this document, and the products and services described herein at any time, without notice.

All ST products are sold pursuant to ST's terms and conditions of sale.

Purchasers are solely responsible for the choice, selection and use of the ST products and services described herein, and ST assumes no liability whatsoever relating to the choice, selection or use of the ST products and services described herein.

No license, express or implied, by estoppel or otherwise, to any intellectual property rights is granted under this document. If any part of this document refers to any third party products or services it shall not be deemed a license grant by ST for the use of such third party products or services, or any intellectual property contained therein or considered as a warranty covering the use in any manner whatsoever of such third party products or services or any intellectual property contained therein.

UNLESS OTHERWISE SET FORTH IN ST'S TERMS AND CONDITIONS OF SALE ST DISCLAIMS ANY EXPRESS OR IMPLIED WARRANTY WITH RESPECT TO THE USE AND/OR SALE OF ST PRODUCTS INCLUDING WITHOUT LIMITATION IMPLIED WARRANTIES OF MERCHANTABILITY, FITNESS FOR A PARTICULAR PURPOSE (AND THEIR EQUIVALENTS UNDER THE LAWS OF ANY JURISDICTION), OR INFRINGEMENT OF ANY PATENT, COPYRIGHT OR OTHER INTELLECTUAL PROPERTY RIGHT.

UNLESS EXPRESSLY APPROVED IN WRITING BY AN AUTHORIZED ST REPRESENTATIVE, ST PRODUCTS ARE NOT RECOMMENDED, AUTHORIZED OR WARRANTED FOR USE IN MILITARY, AIR CRAFT, SPACE, LIFE SAVING, OR LIFE SUSTAINING APPLICATIONS, NOR IN PRODUCTS OR SYSTEMS WHERE FAILURE OR MALFUNCTION MAY RESULT IN PERSONAL INJURY, DEATH, OR SEVERE PROPERTY OR ENVIRONMENTAL DAMAGE. ST PRODUCTS WHICH ARE NOT SPECIFIED AS "AUTOMOTIVE GRADE" MAY ONLY BE USED IN AUTOMOTIVE APPLICATIONS AT USER'S OWN RISK.

Resale of ST products with provisions different from the statements and/or technical features set forth in this document shall immediately void any warranty granted by ST for the ST product or service described herein and shall not create or extend in any manner whatsoever, any liability of ST.

ST and the ST logo are trademarks or registered trademarks of ST in various countries.

Information in this document supersedes and replaces all information previously supplied.

The ST logo is a registered trademark of STMicroelectronics. All other names are the property of their respective owners.

© 2010 STMicroelectronics - All rights reserved

STMicroelectronics group of companies

Australia - Belgium - Brazil - Canada - China - Czech Republic - Finland - France - Germany - Hong Kong - India - Israel - Italy - Japan - Malaysia - Malta - Morocco - Philippines - Singapore - Spain - Sweden - Switzerland - United Kingdom - United States of America

www.st.com