

PACKAGE CONTENTS

- ADAU1761 evaluation board
- USBi control interface board
- USB cable
- Software CD
- Evaluation board documentation/quick-start guide

OTHER SUPPORTING DOCUMENTATION

- ADAU1761 data sheet
- AN-1007 Application Note, Using the ADAU1761 in DSP Bypass Mode to Emulate an ADAU1361
- AN-951 Application Note, Using Hardware Controls with SigmaDSP GPIO Pins
- SigmaStudio Help (included in software installation)

EVALUATION BOARD OVERVIEW

This document explains the design and setup of the ADAU1761 evaluation board.

The EVAL-ADAU1761Z includes both single-ended and differential stereo line-level analog audio inputs as well as a digital audio interface. Single-ended and differential analog outputs are also provided, as well as a stereo capless headphone output.

The USBi provides power and the I²C communications interface to the evaluation board. A switch allows the ADAU1761 to operate at either 3.3 V or 1.8 V. The SigmaStudio™ programming software is used for all register controls and SigmaDSP® core programming.

A header is included for interfacing to stereo digital microphones. GPIO functions, such as push-buttons, LEDs, and switches, can be connected to the GPIO pins of the ADAU1761 for hardware control of the SigmaDSP.

FUNCTIONAL BLOCK DIAGRAM

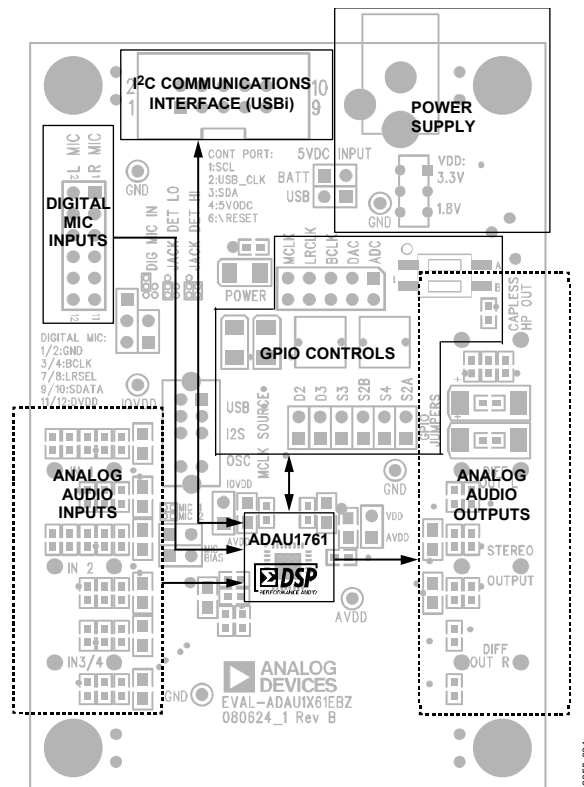

Figure 1.

Rev. 0

Evaluation boards are only intended for device evaluation and not for production purposes. Evaluation boards are supplied "as is" and without warranties of any kind, express, implied, or statutory including, but not limited to, any implied warranty of merchantability or fitness for a particular purpose. No license is granted by implication or otherwise under any patents or other intellectual property by application or use of evaluation boards. Information furnished by Analog Devices is believed to be accurate and reliable. However, no responsibility is assumed by Analog Devices for its use, nor for any infringements of patents or other rights of third parties that may result from its use. Analog Devices reserves the right to change devices or specifications at any time without notice. Trademarks and registered trademarks are the property of their respective owners. Evaluation boards are not authorized to be used in life support devices or systems.

TABLE OF CONTENTS

Package Contents.....	1	Power.....	5
Other Supporting Documentation.....	1	Analog Audio Input	5
Evaluation Board Overview	1	Analog Audio Output.....	5
Functional Block Diagram	1	Clocking the Evaluation Board	6
Revision History	2	External Digital Audio Header.....	6
Setting Up the Evaluation Board—Quick Start.....	3	Digital Microphone and Jack Detection Input.....	6
SigmaStudio Software Installation	3	I ² C Communications Header	6
Hardware Setup, USBi.....	3	GPIO Interface Circuit	7
Powering the Board.....	3	Schematics and Artwork	8
Connecting Audio Cables	3	Ordering Information.....	11
Switch and Jumper Settings.....	3	Bill of Materials.....	11
Your First SigmaStudio Project—EQ and Volume Control....	4	Ordering Guide	12
Using the Evaluation Board.....	5	ESD Caution.....	12
ADAU1761 SigmaDSP.....	5		

REVISION HISTORY

5/09—Revision 0: Initial Version

SETTING UP THE EVALUATION BOARD—QUICK START

SigmaStudio SOFTWARE INSTALLATION

To install the SigmaStudio software, follow these steps:

1. Open the provided .zip file and extract the files to your PC. Alternately, insert the SigmaStudio CD into the PC optical drive and locate the SigmaStudio folder on the CD.
2. If Microsoft® .NET Framework Version 2.0 is not already installed on the PC, install it by double-clicking **dotnetfx.exe**.
3. Install SigmaStudio by double-clicking **setup.exe** and following the prompts. A computer restart is not required.

HARDWARE SETUP, USBi

To set up the USBi hardware, follow these steps:

1. Plug the USBi ribbon cable into Header J1.
2. Connect the USB cable to your computer and to the USBi.
3. When prompted for drivers, follow these steps:
 - a) Choose **Install from a list or a specific location**.
 - b) Choose **Search for the best driver in these locations**.
 - c) Check the box for **Include this location in the search**.
 - d) The USBi driver is located in **C:\Program Files\Analog Devices Inc\Sigma Studio\USB drivers**.
 - e) Click **Next**.
 - f) If prompted to choose a driver, select **CyUSB.sys**.
 - g) If the PC is running Windows® XP and you receive the message that the software has not passed Windows Logo testing, click **Continue Anyway**.

POWERING THE BOARD

The board can be powered either by the USBi or by an external power supply. For the board to run independently from the computer, disconnect Jumper J5 and connect the power supply at J2. The power indicator LED D1 should now be lit.

CONNECTING AUDIO CABLES

In this example, the board is set up for stereo analog inputs and stereo analog outputs, using 3.5 mm (1/8") cables.

1. Connect the audio source to Input Jack J24.
2. Connect Output Jack J19 to your headphones.

SWITCH AND JUMPER SETTINGS

To configure the board for stereo analog input and output, make sure that the switches and jumpers are set as follows (see Figure 2).

- The ADAU1761 uses the on-board oscillator as a master clock source (S5 switched to OSC).
- Regulator output VDD is set for 3.3 V operation (S1 switched to 3.3 V).
- Power is supplied by USB (J5 is connected with a jumper).
- AVDD is connected to VDD (J17 connected).
- IOVDD and AVDD operate at VDD (J16 connected).
- I²C control mode is hardwired on board.

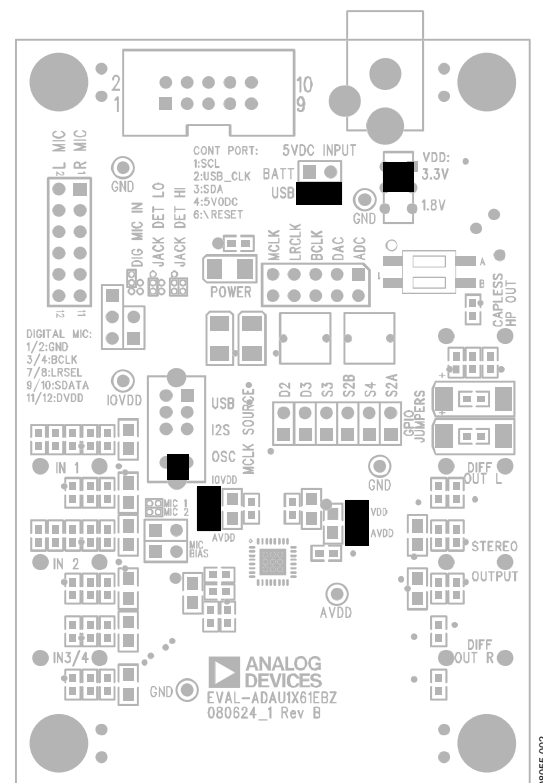

Figure 2. Evaluation Board Setup and Configuration

EVAL-ADAU1761Z

YOUR FIRST SigmaStudio PROJECT—EQ AND VOLUME CONTROL

This section provides a sample first project using SigmaStudio.

1. Create a new project. The **Hardware Configuration** tab will be open.
2. Drag an **ADAU176x** cell and a **USBi** cell into the blank work area.
3. Connect the **USBi** cell to the **ADAU176x** cell by clicking and dragging from the top blue output pin of the **USBi** cell to the green input pin of the **ADAU176x** cell.

Your screen should now resemble Figure 3.

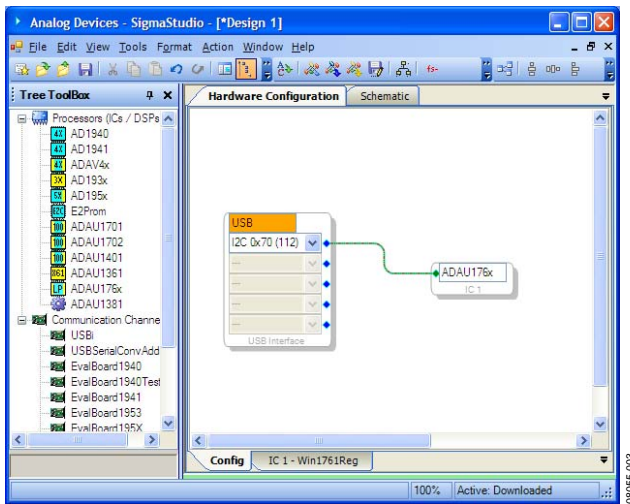

Figure 3. Hardware Configuration Tab

4. In the **IC1-ADAU1761 Register Controls** tab, select the **3 and 4 in, Capless HP Out** option from the **Automatic Startup** list and click **Load Preset** (see Figure 4).

This locks the PLL and sets up the registers for proper routing of the record and playback paths.

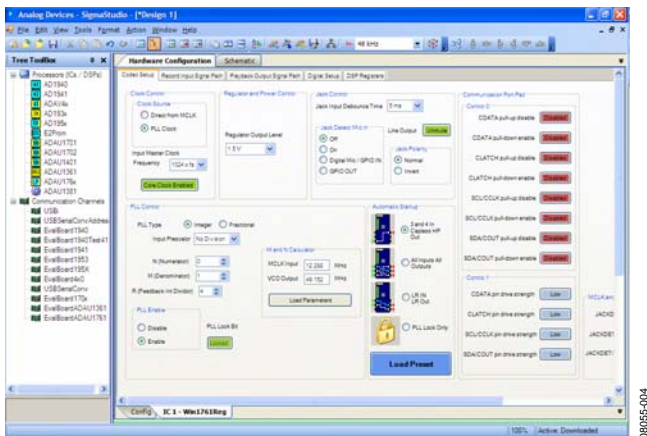

Figure 4. Hardware Configuration Tab—Register Setup

5. Click on the **Schematic** tab at the top of the screen.
6. In the **Tree Toolbox**, expand the **IO > Input** folder. Click and drag an **Input** cell to the work area.
7. Expand the **Filters > Second Order > Double Precision > 2 Ch** folder, then click and drag **Medium Size Eq** to the work area.
8. Right-click the **General (2nd Order)** cell labeled **Gen Filter1**, then click **Grow Algorithm > 1. 2 Channel > Single Precision > 4**. This creates a five-band EQ. The general filter settings for each band can be modified by clicking the blue boxes on the cell.
9. Expand **Volume Controls > Adjustable Gain > Shared Slider > Clickless SW Slew**, then click and drag **Single slew**.
10. Expand the **IO > Output** folder. Click and drag two **Output** cells. By default, these cells are set to **DAC0** (left channel) and **DAC1** (right channel).
11. Connect all the cells as depicted in Figure 5.

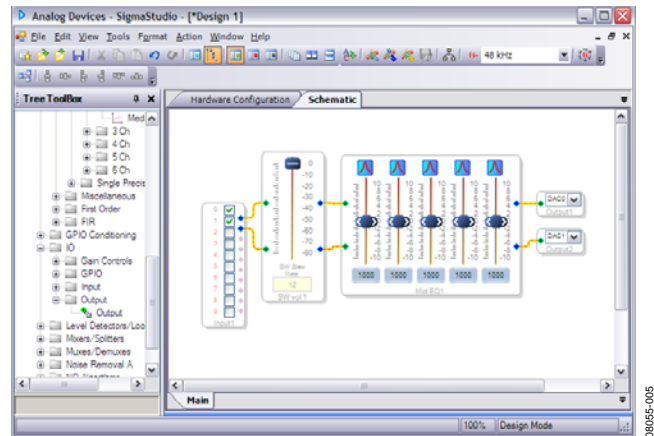

Figure 5. Schematic Tab, Full Design

12. Make sure that your board is powered and connected to the PC. Click **Link-Compile-Download** in SigmaStudio.
13. If the project compiles with no errors, you will be in **Ready-Download** mode (indicated by a green bar across the bottom of the window). Your screen should now resemble Figure 5.
14. Start playing the audio source; you should hear audio on the outputs. You can now move the volume control and filter sliders and hear the effect on the output audio in real time.

USING THE EVALUATION BOARD

ADAU1761 SigmaDSP

The ADAU1761 is a low power, stereo audio codec with integrated digital audio processing that supports stereo 48 kHz record and playback at 10 mW from a 1.8 V analog supply. The stereo audio ADCs and DACs support sample rates from 8 kHz to 96 kHz as well as a digital volume control.

The SigmaDSP core features 28-bit processing (56-bit double precision). The processor allows system designers to compensate for the real-world limitations of microphones, speakers, amplifiers, and listening environments, resulting in a dramatic improvement in the perceived audio quality through equalization, multiband compression, limiting, and third-party branded algorithms.

The SigmaStudio graphical development tool is used to program the ADAU1761. This software includes audio processing blocks such as filters, dynamics processors, mixers, and low level DSP functions for fast development of custom signal flows.

The record path includes an integrated microphone bias circuit and six inputs. The inputs can be mixed and muxed before the ADC, or they can be configured to bypass the ADC. The ADAU1761 includes a stereo digital microphone input.

The ADAU1761 includes five high power output drivers (two differential and three single-ended) that support stereo headphones, an earpiece, or other output transducers. AC-coupled or capless configurations are supported. Individual fine level controls are supported on all analog outputs. The output mixer stage allows for flexible routing of audio.

POWER

The evaluation board uses the [ADP3336](#) low dropout voltage regulator to generate either 3.3 V or 1.8 V for the board. The output voltage VDD of the ADP3336 is set with external resistors, which can be switched with S1 to select either 3.3 V or 1.8 V outputs (see Table 1).

Table 1. VDD Voltage Settings

Voltage Regulator Output (V)	S1 Setting
3.3	Up
1.8	Down

The maximum operating current draw from this board is approximately 75 mA. This maximum value is reached with VDD = 3.3 V, a large SigmaDSP program loaded, headphone outputs enabled, and all LEDs enabled.

Typically, the regulator input comes from the USBi +5 V dc USB supply on Header J1. This supply is enabled with a jumper on J5. To use another +5 V dc supply source, remove the jumper on J5, and connect the other supply either on the J2 power jack (positive tip) or via soldering leads from a supply such as a battery to J3. On J3, Pin 1 (square pad) is ground, and Pin 2 (circle pad) is the power connection.

When the ADP3336 is outputting a regulated voltage, LED D1 is illuminated red.

VDD is connected to the AVDD pin of the ADAU1761 with Jumper J17. To connect the ADAU1761 IOVDD pin to the same supply, connect J16, also. These headers can also be used to separate the supplies of the ADAU1761 from the rest of the board and to connect an external supply to the ADAU1761.

L1 and C24 are connected to the AVDD pin of the ADAU1761 and function as an L-C filter to reject high frequency power supply noise common in GSM mobile applications. This filter is tuned to approximately 1.5 GHz.

ANALOG AUDIO INPUT

The EVAL-ADAU1761Z has three ac-coupled 1/8" input jacks: two mono differential jacks and one stereo single-ended jack. The tips of the differential input jacks, J20 and J22 (labeled IN 1 and IN 2), are connected to the negative input of the ADAU1761, and the rings are connected to the positive input. The stereo single-ended input on J24 (labeled IN 3) is connected to the LAUX and RAUX inputs of the ADAU1761. IN 1 and IN 2 can also be configured to bias a microphone. This is enabled by connecting the MICBIAS pin of the ADAU1761 to the tip of the input connectors with Jumper J15 and Jumper J18.

At VDD = 3.3 V, the full-scale analog input level of the EVAL-ADAU1761Z is 1.0 V rms (1.0 V rms on the single-ended inputs and 0.5 V rms on each of the two pins of the differential inputs). The full-scale input level scales with VDD.

ANALOG AUDIO OUTPUT

The EVAL-ADAU1761Z has four 1/8" output jacks: two mono differential, one stereo single-ended, and one stereo capless headphone output. The differential outputs on J21 and J25 (labeled DIFF OUT L and DIFF OUT R, respectively) are biased at AVDD/2 V. The tips of the differential output jacks are connected to the positive output of the ADAU1761, and the rings are connected to the negative outputs. J23 is a stereo, single-ended, ac-coupled output.

At VDD = 3.3 V, the full-scale analog output level of the EVAL-ADAU1761Z is 1.0 V rms (1.0 V rms on the single-ended outputs and 0.5 V rms on each of the two pins of the differential outputs). The differential line outputs of the ADAU1761 can each be boosted by 6 dB to 2.0 V rms. The full-scale output level scales with VDD.

Note that Jack J21 and Jack J25 tie the ring to the sleeve, resulting in a floating ground output. Be aware of this when connecting to these outputs.

EVAL-ADAU1761Z

Table 2. Analog and Digital Audio Connectors

Jack	Function
J4	Stereo digital microphone input
J6	Serial data port input/output
J19	Capless headphone output
J20	Left differential input
J21	Left differential output
J22	Right differential input
J23	Stereo single-ended line output
J24	Stereo single-ended line input
J25	Right differential output

CLOCKING THE EVALUATION BOARD

The EVAL-ADAU1761Z requires a master clock to operate. The source of this clock is set by Switch S5 (see Table 3).

Table 3. Master Clock Source Settings

Clock Source	S5 Setting
Do not use—function disabled on USBi	Up
MCLK from Header J6	Middle
On-board 12.288 MHz clock oscillator (U3)	Down

EXTERNAL DIGITAL AUDIO HEADER

The LRCLK, BCLK, ADC_SDATA, and DAC_SDATA pins of the ADAU1761 can be connected to external devices with the 5 × 2 Header J6. The pins on the top row of J6 are connected to ground; the pins on the bottom row are the signals indicated on the silkscreen.

In SigmaStudio, the digital input channels (Channel 0 to Channel 7) are accessed in the input cell in Position 2 to Position 9, as shown in Figure 6. Position 0 and Position 1 are inputs from the ADCs.

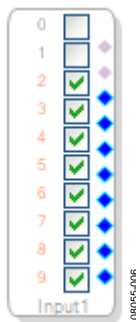

Figure 6. Digital Audio Inputs 0 to 7 in SigmaStudio Input Cell

DIGITAL MICROPHONE AND JACK DETECTION INPUT

A pair of digital microphones can be connected to the evaluation board on Header J4. The pin connections for J4 are detailed on the evaluation board silkscreen.

J7 and J8 set up the routing of signals to the JACKDET/MICIN pin of the ADAU1761. These jumper settings are shown in Figure 7, Figure 8, and Figure 9; they are also shown on the PCB silkscreen. Toggling the jack detection signal can be simulated by setting up the jack detect function on the ADAU1761 and then inserting and removing Jumper J8 with J7-B (lower connection) connected.

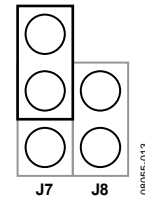

Figure 7. Jumper Settings (J7 and J8) for Stereo Digital Microphone Input

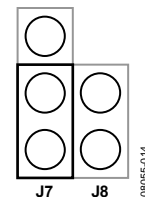

Figure 8. Jumper Settings (J7 and J8) for Jack Detection (Low Signal Detected)

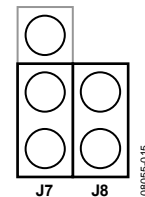

Figure 9. Jumper Settings (J7 and J8) for Jack Detection (High Signal Detected)

I²C COMMUNICATIONS HEADER

The I²C communications header, J1, provides an interface to the ADAU1761 communications port. This header connects to the USBi board (EVAL-ADUSB2), which controls communication between the evaluation board and SigmaStudio on the PC. Additionally, a DSP reset line and USB bus power line are provided. The SigmaStudio hardware configuration for this setup is shown in Figure 10.

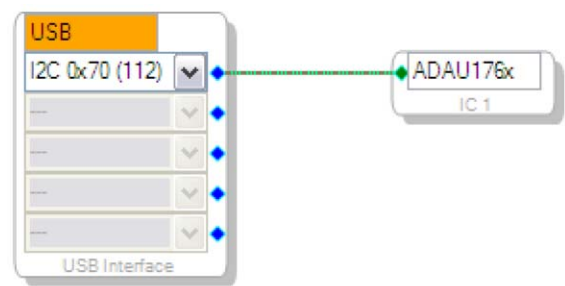

Figure 10. Using the EVAL-ADAU1761Z and the USBi with SigmaStudio

GPIO INTERFACE CIRCUIT

The ADAU1761 has four GPIO pins that can be used to interface to external digital controls. These dual-function pins can also be used as the serial data port; only one of these two functions can be used at one time. On the EVAL-ADAU1761Z, the GPIO pins are connected to buttons, switches, and LEDs through a bank of jumpers, J9 to J14. Jumpers should be attached to the headers to use the on-board GPIO functions; these jumpers are in place to decouple the GPIO circuits from the serial data port when the pins are used for the serial data port function.

Table 4 shows which ADAU1761 pins are connected to the different GPIO functions and the associated jumper for each. Note that GPIO0 and GPIO1 can each be connected to both a push-button and a DIP switch. Make sure to connect only one of these functions to a pin at a time.

Table 4. GPIO Setup

Jumper	ADAU1761 Pin	Device	Settings	SigmaStudio Setting
J9	GPIO3	Green LED D2	Active high	Output set by DSP core with pull-up
J10	GPIO2	Yellow LED D3	Active high	Output set by DSP core with pull-up
J11	GPIO0	Push-button S3	Push to ground	Input with debounce
J12	GPIO0	DIP switch S2-B	Right low, left high	Input with debounce
J13	GPIO1	Push-button S4	Push to ground	Input with debounce
J14	GPIO1	DIP switch S2-A	Right low, left high	Input with debounce

In SigmaStudio, the GPIO functions must be enabled and set to the appropriate function in the DSP Register tab, as shown in Figure 11. The GPIO input and output blocks must also be instantiated in the DSP schematic window (see Figure 12).

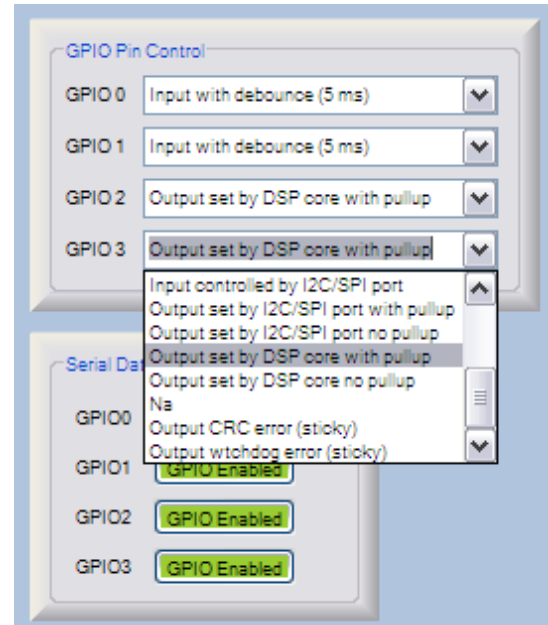

Figure 11. GPIO Settings in SigmaStudio for the ADAU1761

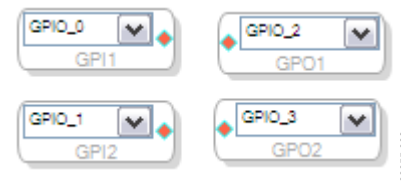
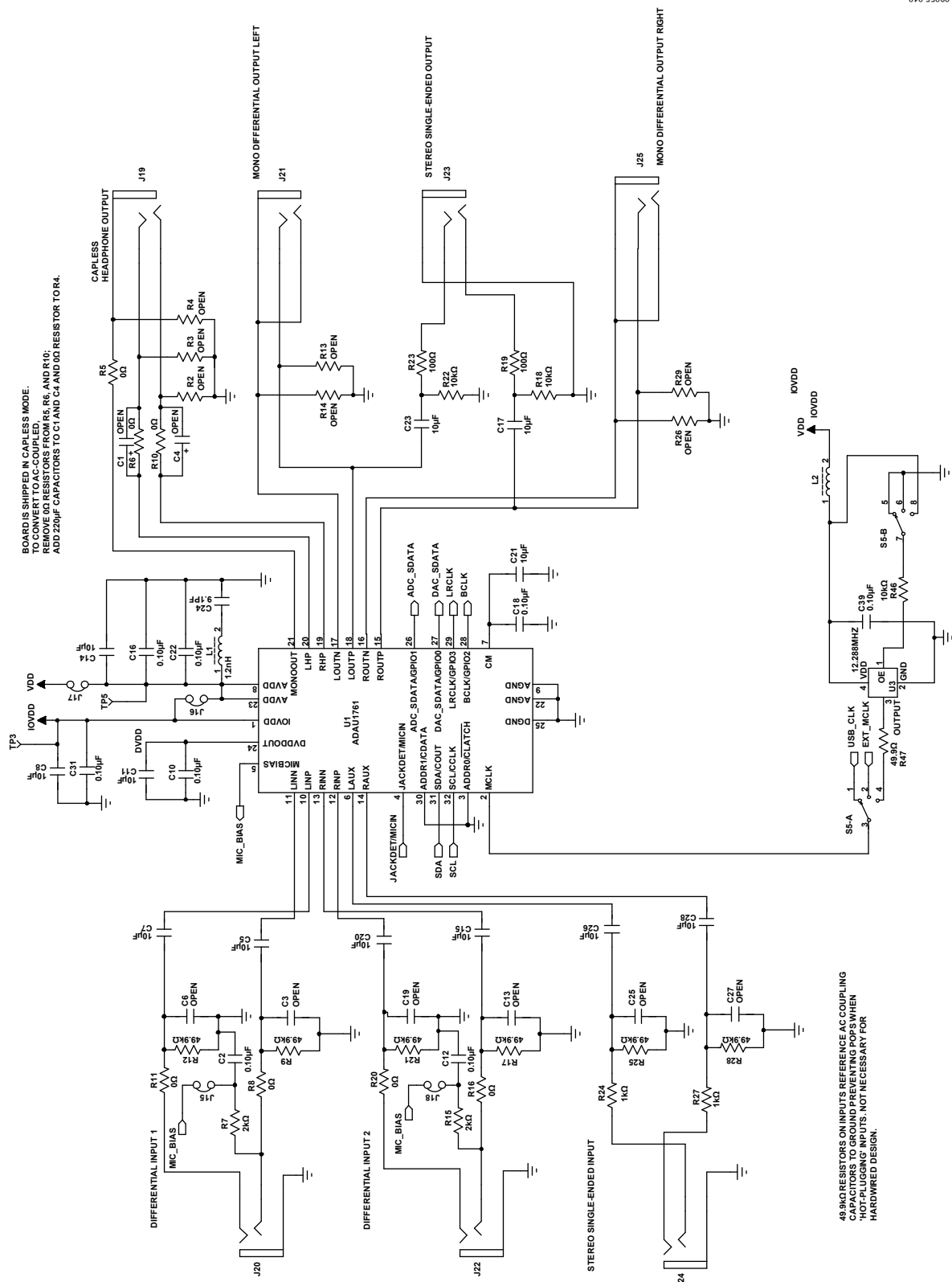

Figure 12. GPIO Input and Output Blocks in SigmaStudio

SCHEMATICS AND ARTWORK



01-55008

Figure 13. Board Schematics, Page 1

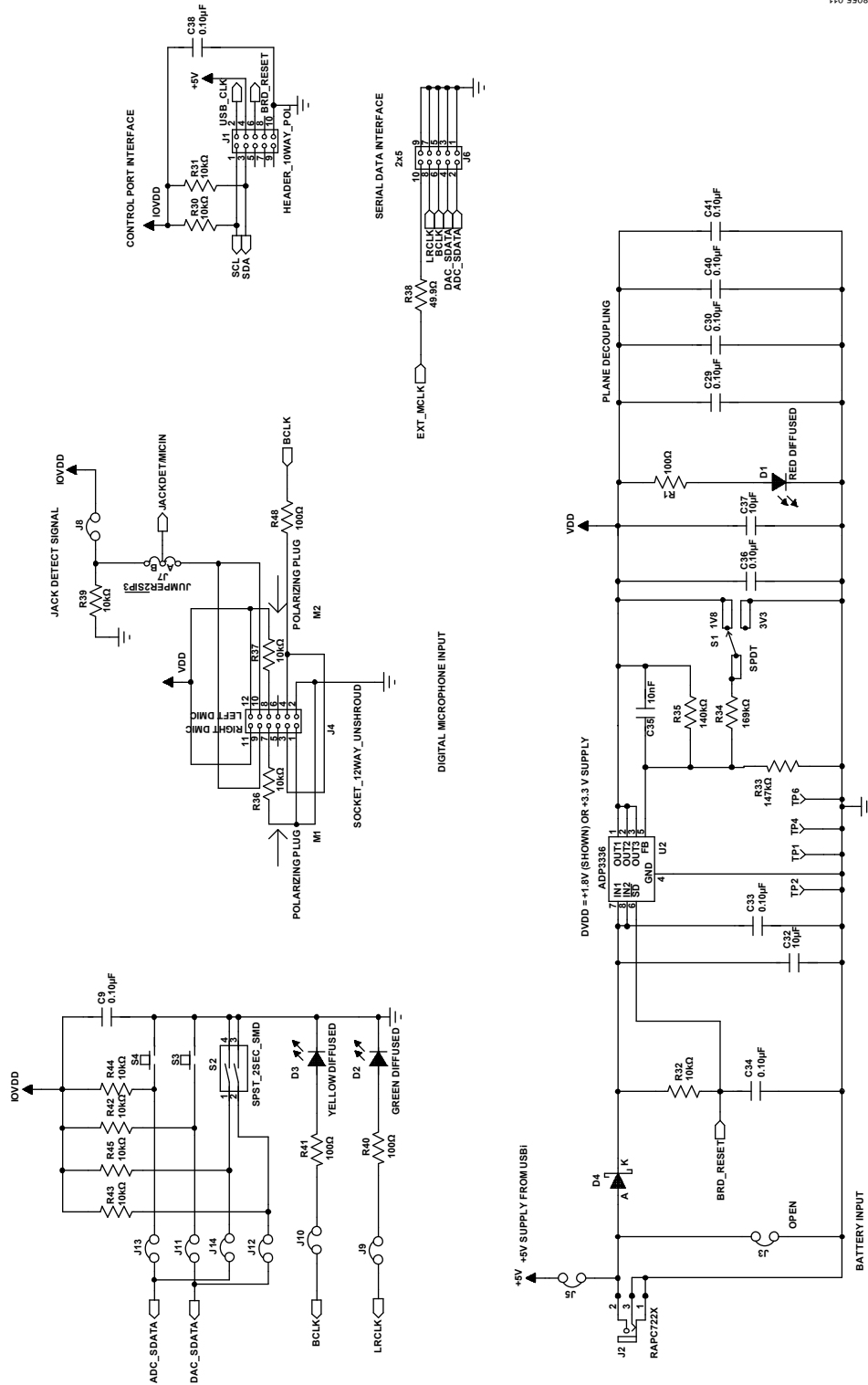

Figure 14. Board Schematics, Page 2

EVAL-ADAU1761Z

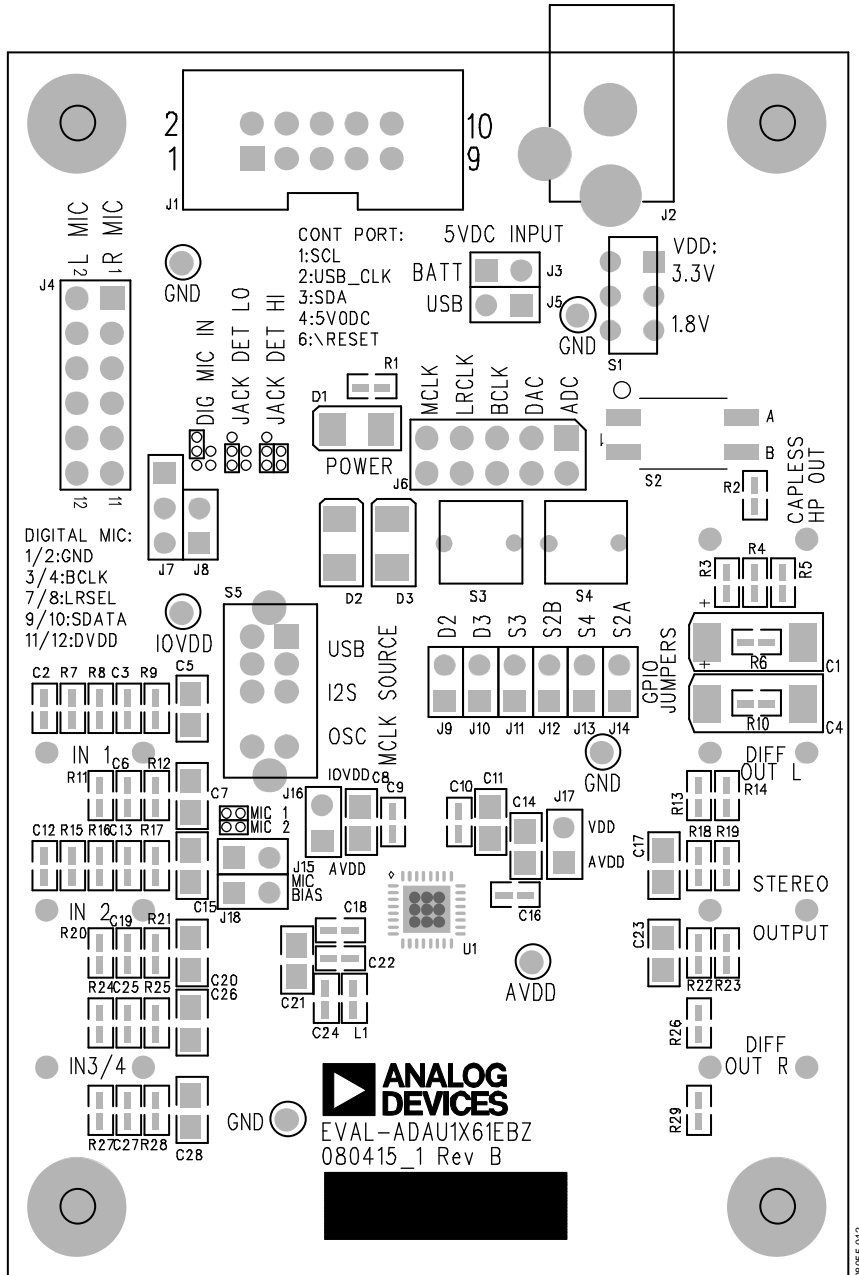

Figure 15. Board Silkscreen and Parts Placement

ORDERING INFORMATION

BILL OF MATERIALS

Table 5.

Qty	Designator	Description	Manufacturer	Part Number
2	C1, C4	Capacitor (open)		
13	C2, C9, C10, C12, C16, C18, C22, C31, C33, C34, C36, C38, C39	Capacitor, multilayer ceramic, 0.10 μ F, 50 V, X7R, 0603	Panasonic	ECJ-1VB1H104K
6	C3, C6, C13, C19, C25, C27	Capacitor (open)		
14	C5, C7, C8, C11, C14, C15, C17, C20, C21, C23, C26, C28, C32, C37	Capacitor, multilayer ceramic, 10 μ F, 10 V, X7R, 0805	Murata	GRM21BR71A106KE51L
1	C24	Capacitor, multilayer ceramic, 9.1 pF, 50 V, NP0, 0603	Murata	GQM1885C1H9R1CB01D
4	C29, C30, C40, C41	Capacitor, multilayer ceramic, 0.10 μ F, 16 V, X7R, 0402	Panasonic	ECJ-0EX1C104K
1	C35	Capacitor, multilayer ceramic, 10 nF, 25 V, NP0, 0603	TDK	C1608C0G1E103J
1	D1	LED, red diffused, 6 millicandela, 635 nm, 1206	Lumex	SML-LX1206IW-TR
1	D2	LED, green diffused, 10 millicandela, 565 nm, 1206	Lumex	SML-LX1206GW-TR
1	D3	LED, yellow diffused, 4 millicandela, 585 nm, 1206	CML Innovative Technologies	CMD15-21VYD/TR8
1	D4	Schottky diode, 30 V, 0.5 A, SOD-123	ON Semiconductor	MBR0530T1G
1	J1	Header, 10-way (2 \times 5), shrouded, polarized	3M	N2510-6002RB
1	J2	Mini power jack, 0.08", R/A T/H	Switchcraft, Inc.	RAPC722X
1	J3	Open		
1	J4	Header, 12-way (2 \times 6), socket, unshrouded	Sullins Connector Solutions	PPPC062LFBN-RC
12	J5, J8 to J18	Header, 2-pin, unshrouded, 2-jumper, 0.10" (use Tyco shunt, 881545-2)	Sullins Connector Solutions	PBC02SAAN
1	J6	Header, 10-way (2 \times 5), unshrouded	Sullins Connector Solutions	PBC05DAAN
1	J7	Header, 3-position, SIP	Sullins Connector Solutions	PBC03SAAN
7	J19 to J25	Stereo mini jack, SMT	CUI Inc.	SJ-3523-SMT
1	L1	Inductor, 1.2 nH	Jaro Components, Inc.	HFI-160808-1N2S
1	L2	Chip ferrite bead, 600 Ω @ 100 MHz	TDK	MPZ1608S601A
6	R1, R19, R23, R40, R41, R48	Chip resistor, 100 Ω , 1%, 100 mW, thick film, 0603	Panasonic	ERJ-3EKF1000V
7	R2 to R4, R13, R14, R26, R29	Resistor, open		
7	R5, R6, R8, R10, R11, R16, R20	Chip resistor, 0 Ω , 5%, 100 mW, thick film, 0603	Panasonic	ERJ-3GEY0R00V
2	R7, R15	Chip resistor, 2 k Ω , 1%, 100 mW, thick film, 0603	Panasonic	ERJ-3EKF2001V
6	R9, R12, R17, R21, R25, R28	Chip resistor, 49.9 k Ω , 1%, 100 mW, thick film, 0603	Panasonic	ERJ-3EKF4992V
13	R18, R22, R30 to R32, R36, R37, R39, R42 to R46	Chip resistor, 10 k Ω , 1%, 100 mW, thick film, 0603	Panasonic	ERJ-3EKF1002V
2	R24, R27	Chip resistor, 1 k Ω , 1%, 100 mW, thick film, 0603	Panasonic	ERJ-3EKF1001V
1	R33	Chip resistor, 147 k Ω , 1%, 100 mW, thick film, 0603	Panasonic	ERJ-3EKF1473V
1	R34	Chip resistor, 169 k Ω , 1%, 100 mW, thick film, 0603	Panasonic	ERJ-3EKF1693V
1	R35	Chip resistor, 140 k Ω , 1%, 100 mW, thick film, 0603	Panasonic	ERJ-3EKF1403V
2	R38, R47	Chip resistor, 49.9 Ω , 1%, 100 mW, thick film, 0603	Panasonic	ERJ-3EKF49R9V

EVAL-ADAU1761Z

Qty	Designator	Description	Manufacturer	Part Number
1	S1	Slide switch, SPDT, PC mount, L = 2 mm	E-Switch	EG1271
1	S2	SMD dip switch, 2-section SPST, raised actuator	CTS Corporation	219-2LPST
2	S3, S4	Tact switch, long stroke (normally open)	Omron Electronics	B3M-6009
1	S5	Slide switch, DP3T, PC mount, L = 4 mm	E-Switch	EG2305
6	TP1 to TP6	Mini test point, white, 0.1" OD	Keystone Electronics	5002
1	U1	SigmaDSP codec	Analog Devices	ADAU1761BCPZ
1	U2	Adjustable low dropout voltage regulator	Analog Devices	ADP3336ARMZ
1	U3	SMD oscillator, 12.288 MHz, fixed, 1.8 VDC to 3.3 VDC	Abracon Corporation	AP35-12.288MHz-F-J-B

ORDERING GUIDE

Model	Description
EVAL-ADAU1761Z ¹	Evaluation Board

¹ Z = RoHS Compliant Part.

ESD CAUTION



ESD (electrostatic discharge) sensitive device. Charged devices and circuit boards can discharge without detection. Although this product features patented or proprietary protection circuitry, damage may occur on devices subjected to high energy ESD. Therefore, proper ESD precautions should be taken to avoid performance degradation or loss of functionality.

Purchase of licensed I²C components of Analog Devices or one of its sublicensed Associated Companies conveys a license for the purchaser under the Philips I²C Patent Rights to use these components in an I²C system, provided that the system conforms to the I²C Standard Specification as defined by Philips.

©2009 Analog Devices, Inc. All rights reserved. Trademarks and registered trademarks are the property of their respective owners.
EB08055-0-5/09(0)



www.analog.com