

TEST DATA

ITEM	SPEC	SAMPLE									
		1	2	3	4	5	6	7	8	9	10
Primary Exciting Current Input 120VAC, 60 Hz	60 mA max	34	31	35							
Primary Load Current Input 120 VAC, 60 Hz	95 mA max	87	85	88							
Secondary No Load AC Voltage	15V ±5%	14.9	14.83	14.87							
Secondary AC Voltage Load 600 mA	12V ±5%	11.94	11.92	11.98							
Secondary Voltage Load mA	V ± %										
Secondary Voltage Load mA	V ± %										
Secondary Voltage Load mA	V ± %										
Secondary Voltage Load mA	V ± %										
Ripple Voltage Load mA (PK-PK)	V max										
Hi-Pot Test 3 mA for 3Sec.	Pri. to Sec.	2K VAC	OK	OK	OK						
	Pri. to Core	2K VAC	OK	OK	OK						
	Sec. to Core	1.5K VAC	OK	OK	OK						
Temperature Rise: 70°C MAX measured By Resistance Method (Primary Winding)											
Core Film: SPLIT						Core : EI-35					
Testing Circuit:						Output plug Drawing PLUG: 3.5*14mm					
											
Output conductor length: 6FT min (AWG#22)											
Input conductor length: ft min (AWG#)											
<p>(V)</p> <p style="text-align: center;">Characteristic Curve</p>  <p style="text-align: right;">(mA)</p>											

AC Adaptor Specifications

Internal Construction Drawing and Parts List (Unit: Set or EA)

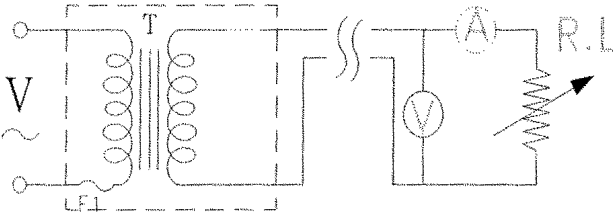
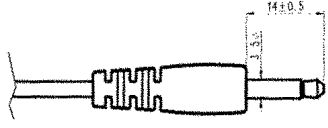
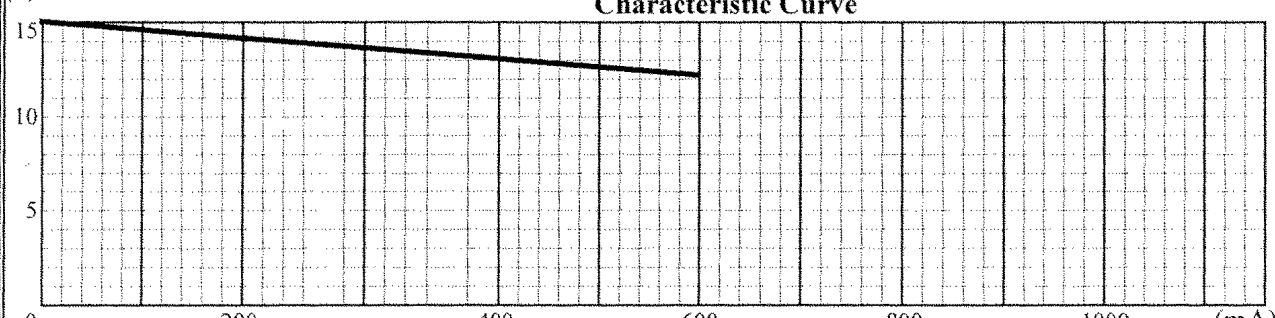
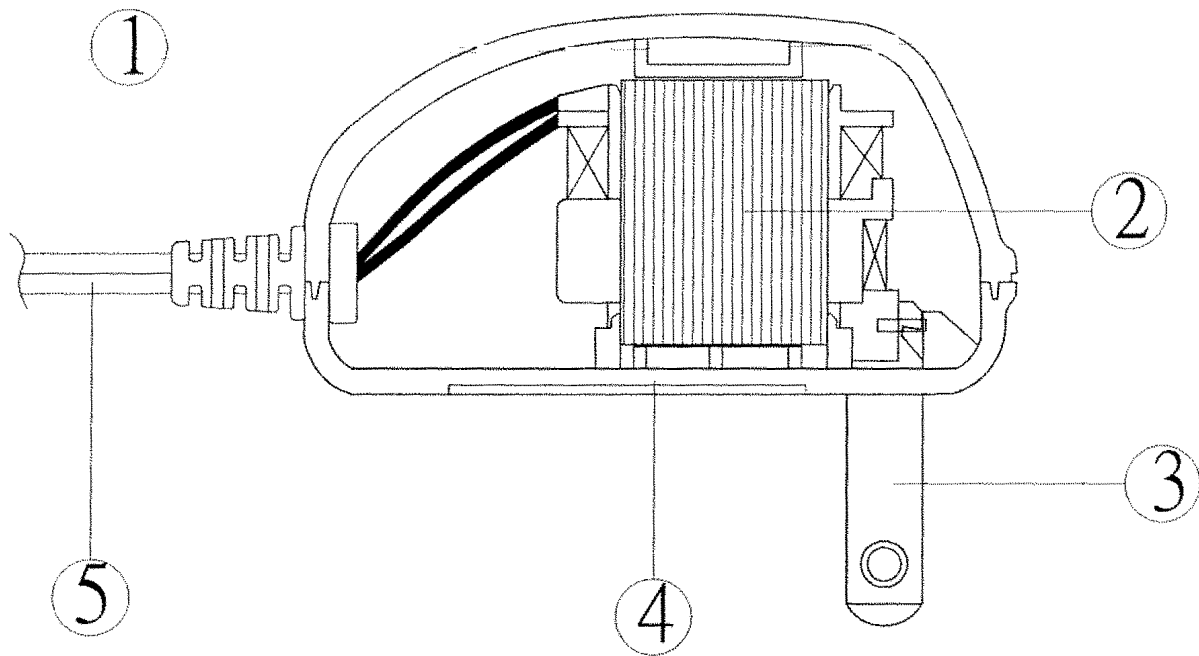

Part Name	Specification	Q'ty
1. Enclosure	Noryl PX1700 94V-1 95°C	
2. Transformer	EI-35	1
3. Blade	Ni plated brass	2
4. Name Plate	Polyester Film	1
5. Output Cord	AWG# 22 6FT min	1

AC Adaptor Specifications

Construction Drawing and Details of Transformer

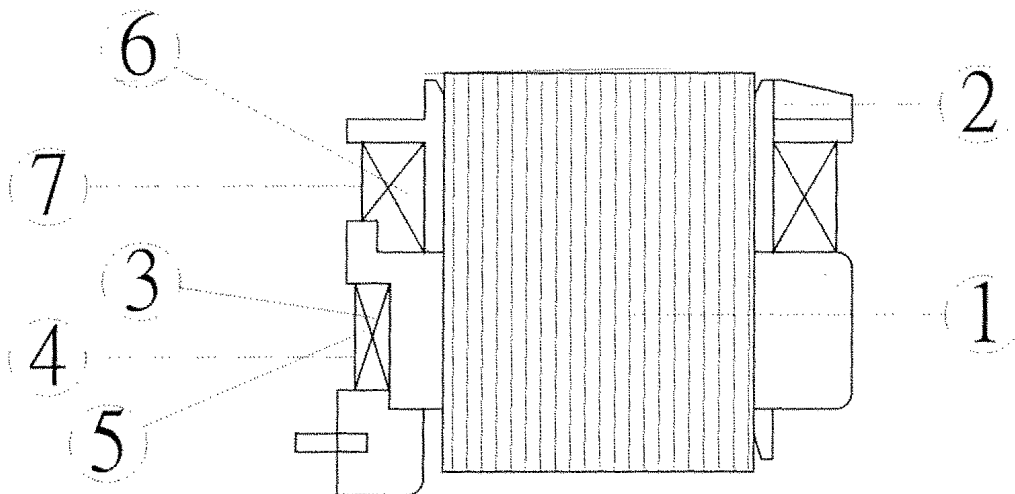

Part Name	Material & Type	Spec or Q'ty
1. Core	Silicon Steel	0.5mm
2. Bobbin	Polybutylene Terephthalate	0.71mm
	1403G6	
	PETP(QMFZ2)	
	FR-530, FR530L Nylon 101L	
3. Primary Winding	Polyurethane Enameled Copper wire	mm turn ohm
4. Primary Outer Winding	Mylar Tape	0.025mmx2T
5. Thermal Fuse	M30 2A 125°C 250V AC	1PC
6. Secondary Winding	Polyurethane Enameled Copper Wire	mm turn ohm
7. Secondary Outer Winding	Mylar Tape	0.025mmx2T

AC Adaptor Specifications

Circuit Diagram

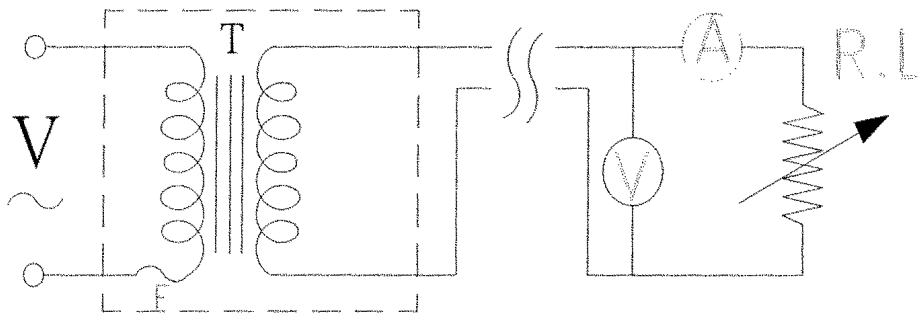

Symbol	Part Name	Note
T	Transformer	EI-35
F	Thermal	125°C 2A 250V

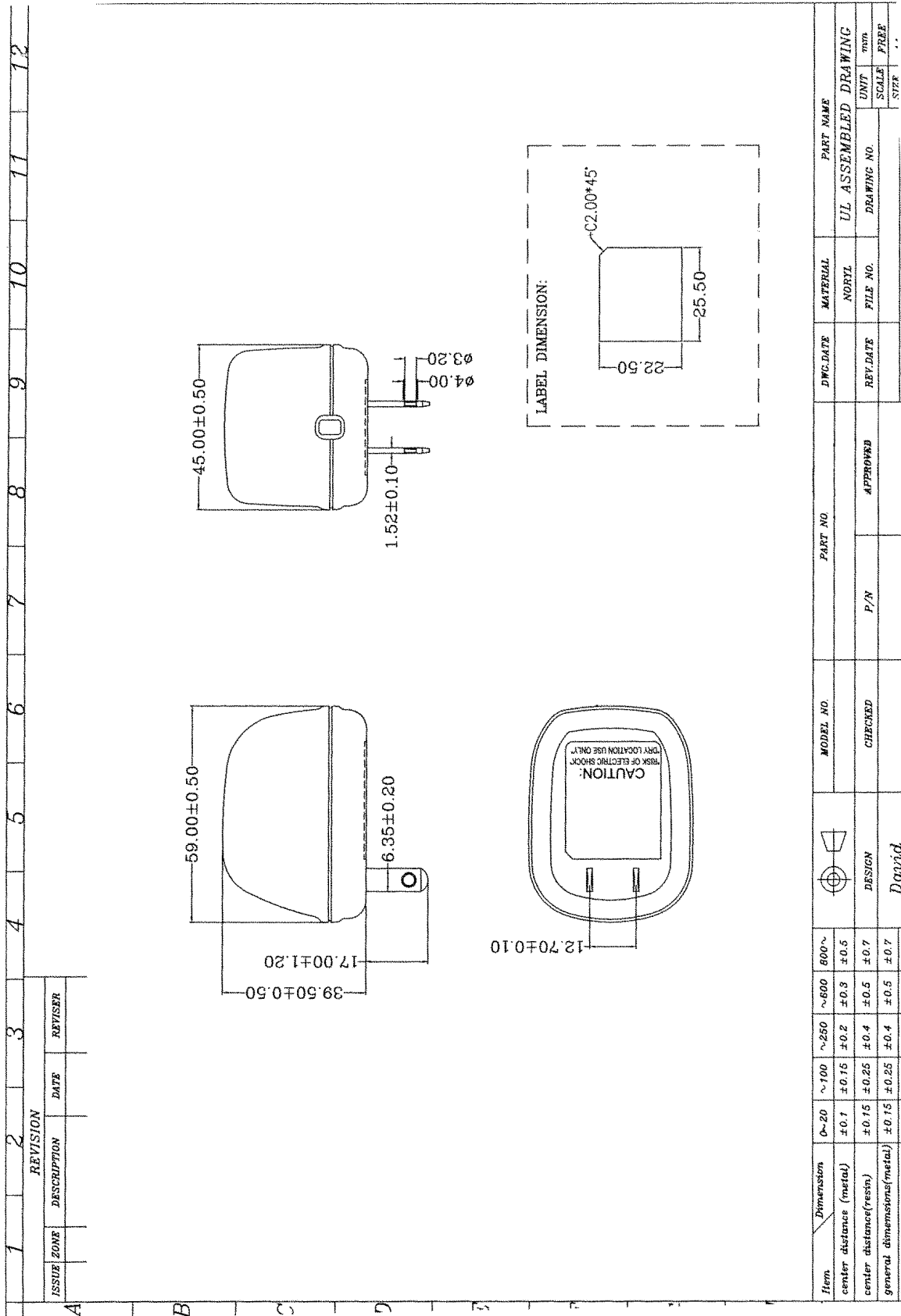

AC Adaptor Specifications

Dimension of Nameplate (Unit:mm)

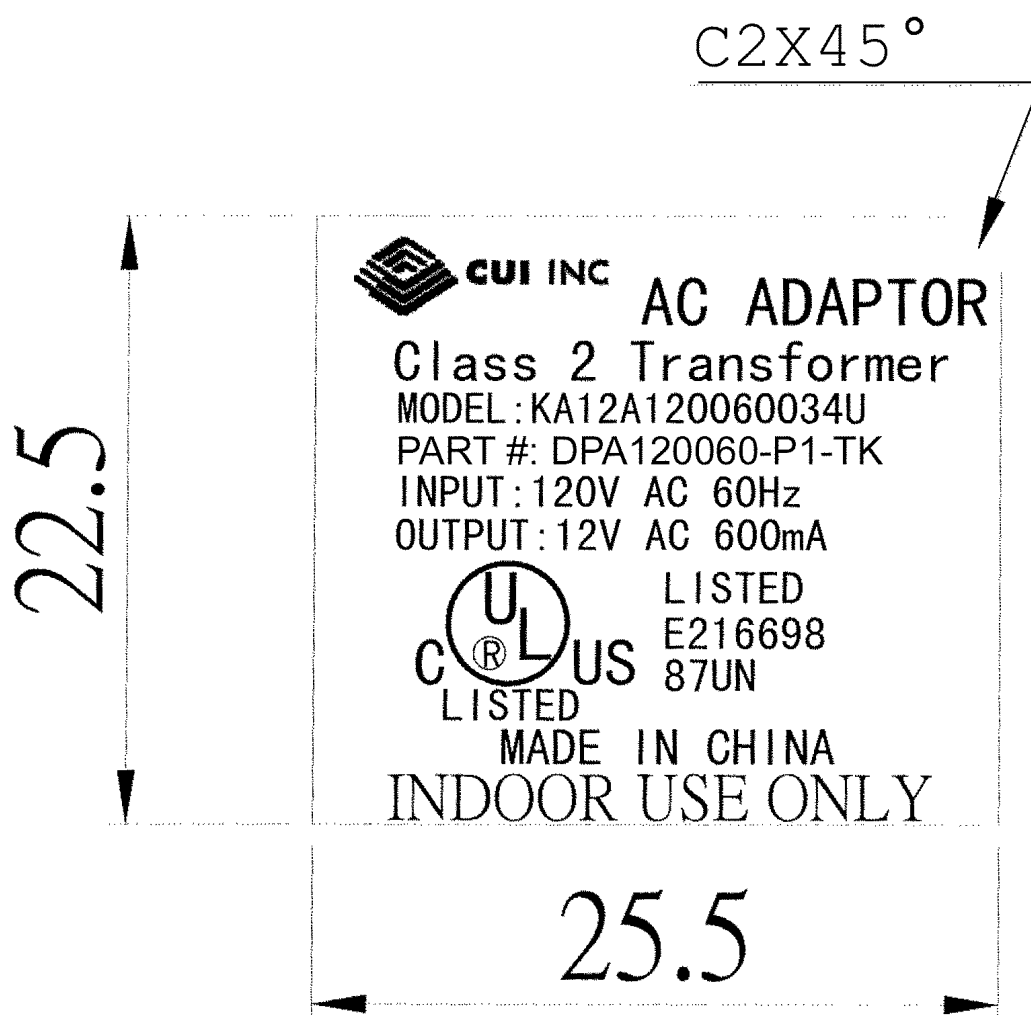

Material: Polyester Film

T: 0.25mm