

TEST DATA

ITEM	SPEC	SAMPLE									
		1	2	3	4	5	6	7	8	9	10
Primary Exciting Current Input 120VAC, 60 Hz	85 mA max	47	52	52							
Primary Load Current Input 120 VAC, 60 Hz	160 mA max	140	141	140							
Secondary No Load AC Voltage	15V ±5%	15.07	15.09	15.09							
Secondary AC Voltage Load 1000 mA	12V ±5%	12.02	12	12.03							
Secondary Voltage Load mA	V ± %										
Secondary Voltage Load mA	V ± %										
Secondary Voltage Load mA	V ± %										
Secondary Voltage Load mA	V ± %										
Ripple Voltage Load mA (PK-PK)	V max										
Hi-Pot Test 3 mA for 3Sec.	Pri. to Sec.	2K VAC	OK	OK	OK						
	Pri. to Core	2K VAC	OK	OK	OK						
	Sec. to Core	1.5K VAC	OK	OK	OK						
Temperature Rise: 70°C MAX measured By Resistance Method (Primary Winding)											
Core Film: SPLIT Core: EI-41											
Testing Circuit:						Output plug Drawing					
											
Output conductor length: 6FT min (AWG#22)											
Input conductor length: ft min (AWG#)											
Characteristic Curve 											

0AC Adaptor Specifications

Internal Construction Drawing and Parts List (Unit: Set or EA)

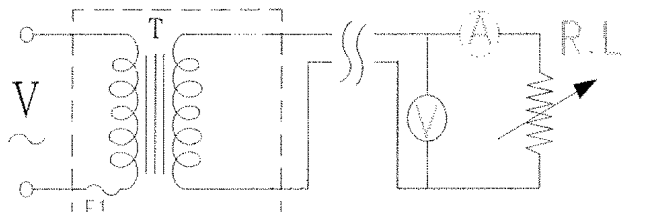
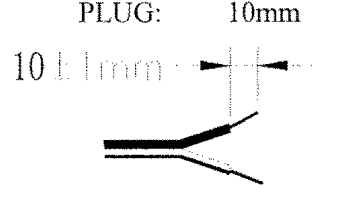
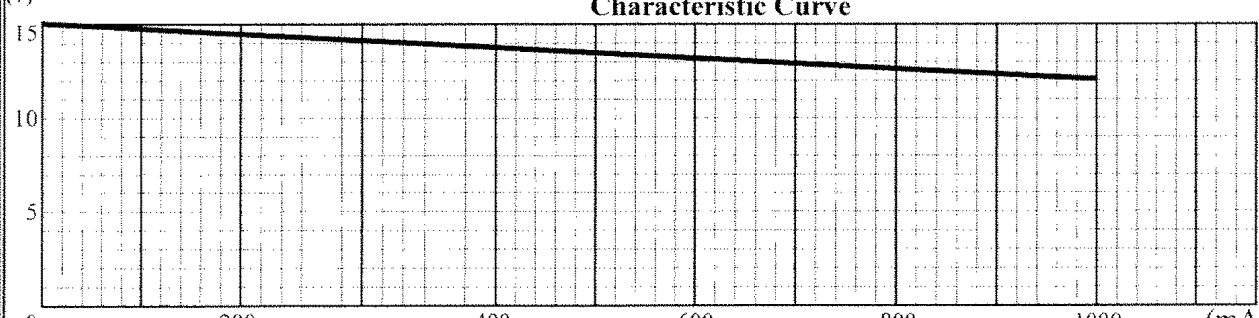
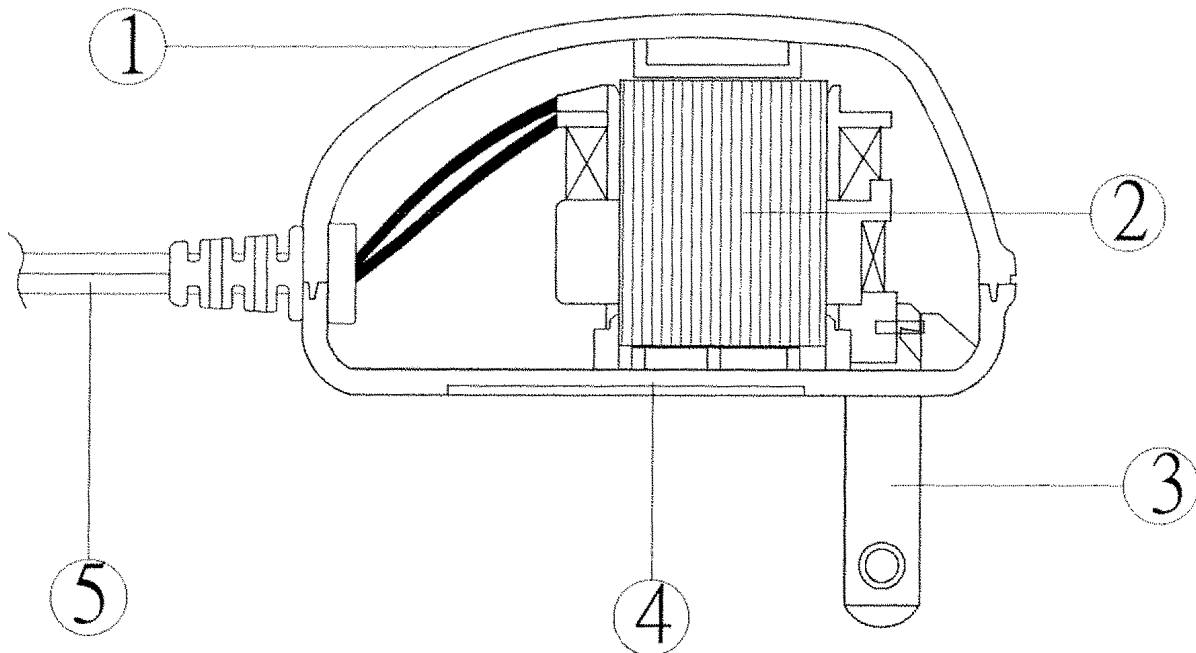

Part Name	Specification	Q'ty
1. Enclosure	Noryl SE1 94V-0 105°C	
	Noryl SE-100 94V-0 95°C	
	Noryl PX1700 94V-0 95°C	
	940(f1) 94V-0 130°C	
2. Transformer	EI-41	1
3. Blade	Ni plated brass	2
4. Name Plate	Polyester Film	1
5. Output Cord	AWG#22 6FT min	1

AC Adaptor Specifications

Construction Drawing and Details of Transformer

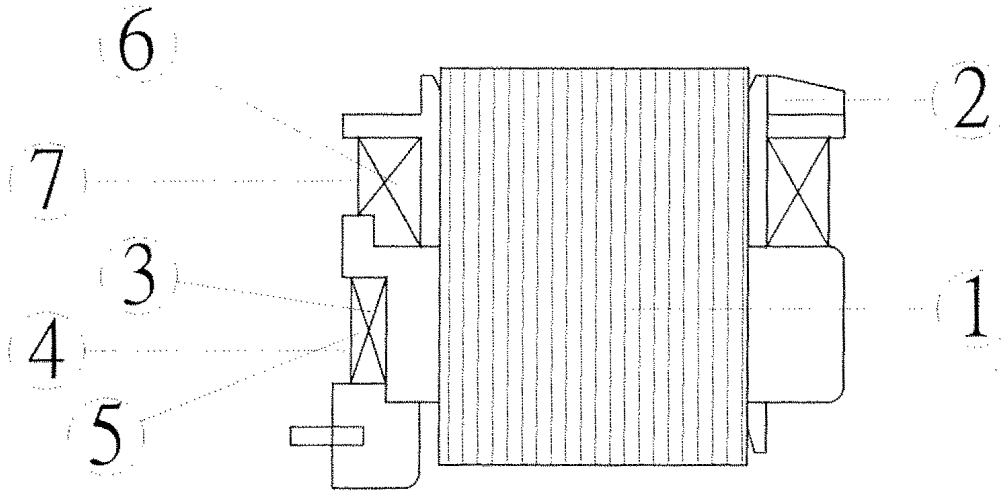

Part Name	Material & Type	Spec or Q'ty
1. Core	Silicon Steel	0.35mm
2. Bobbin	Polybutylene Terephthalate 1403G6	0.71mm
	PETP(QMFZ2) FR-530, FR530L	
	Nylon 101L	
3. Primary Winding	Polyurethane Enameled Copper wire	mm turn ohm
4. Primary Outer Winding	Mylar Tape	0.025mmx2T
5. Thermal Fuse(Optional)	M30 2A 125°C 250V AC	1PC
6. Secondary Winding	Polyurethane Enameled Copper Wire	mm turn ohm
7. Secondary Outer Winding	Mylar Tape	0.025mmx2T

AC Adaptor Specifications

Circuit Diagram

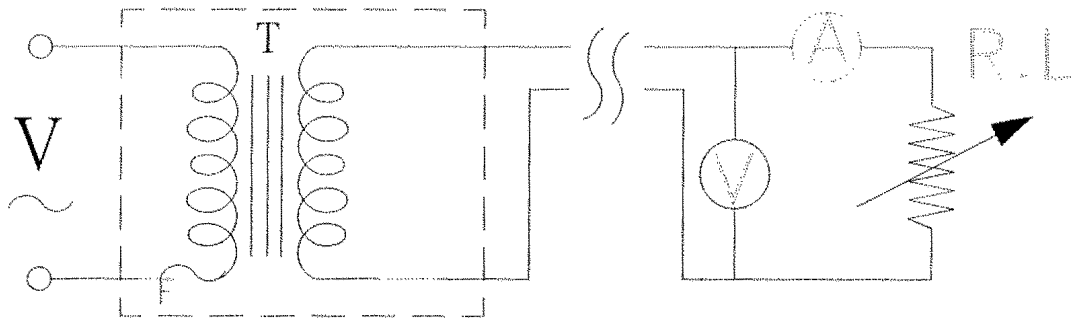

Symbol	Part Name	Note
T	Transformer	EI-41
F	Thermal	125°C 2A 250V

AC Adaptor Specifications

Dimension of Nameplate (Unit:mm)

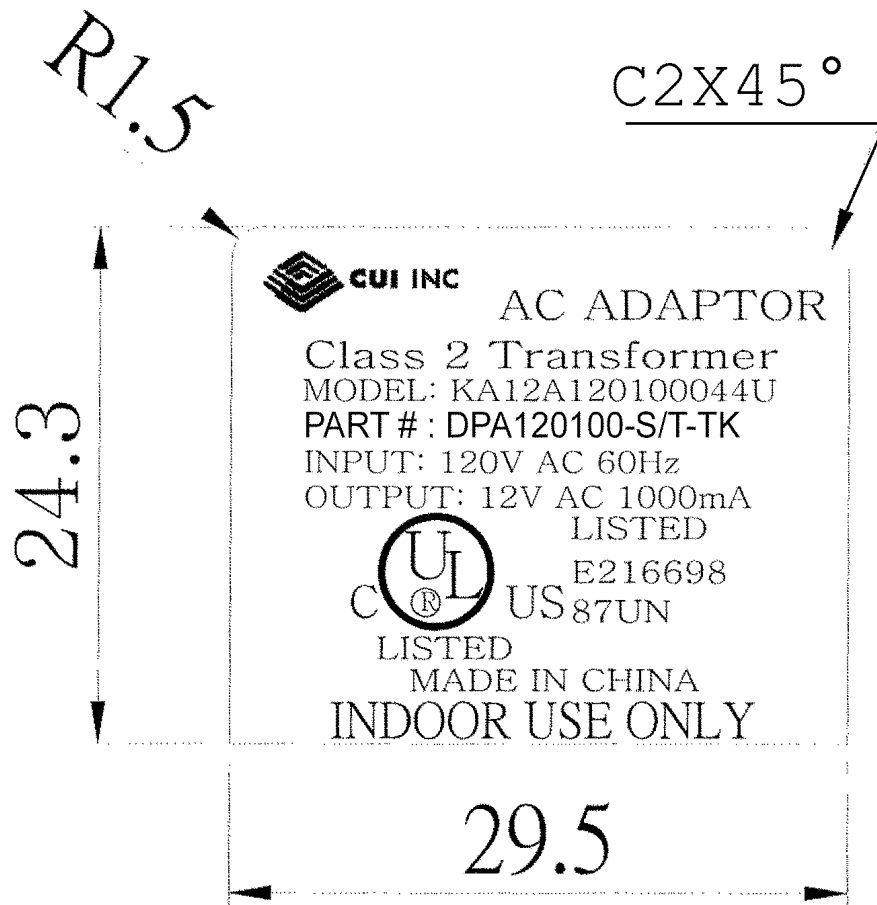

Material: Polyester Film

T: 0.25mm