

**Specifications**

Output voltage	6 V ac at 500 mA	
Rated input voltage	120 V ac	
Primary rated voltage	120 V ac 60 Hz 5 W	
Primary exciting current	30 mA rms max.	
Secondary rated voltage & current	no load voltage (max.)	7.5 V ref
	full load voltage (500 mA)	6 V $\pm$ 5%
Temperature rise of primary winding (full load)	70°C max. using resistance method	
Insulation resistance	$\geq$ 100 M Ohm at 500 V dc	
HI-POT test	from input to output for 1 min.	1240 V ac at 2 mA
	from input to output for 1 sec.	1600 V ac at 2 mA
	from primary to secondary winding for 1 sec.	1600 V ac at 2 mA
	from primary winding to core for 1 sec.	1600 V ac at 2 mA
	from secondary winding to core for 1 sec.	750 V ac at 2 mA
Safety standards	UL/cUL	
RoHS compliant	yes	
No load power consumption	0.5 W max.	
Efficiency	Energy Star Compliant - Efficiency Level IV	
Test conditions	Ambient temp	40°C $\pm$ 2°C
	Humidity	90-95% 96 hours at Full Load
	Rated voltage	8 hours at full load
Adapter color	Case	black
	Cord	black



**CUI INC**

Part No: EPA060050-S/T-SZ

Date: 5/11/2007

Unit: mm

Description: linear power supply

Page No: 2 of 7

**Label**

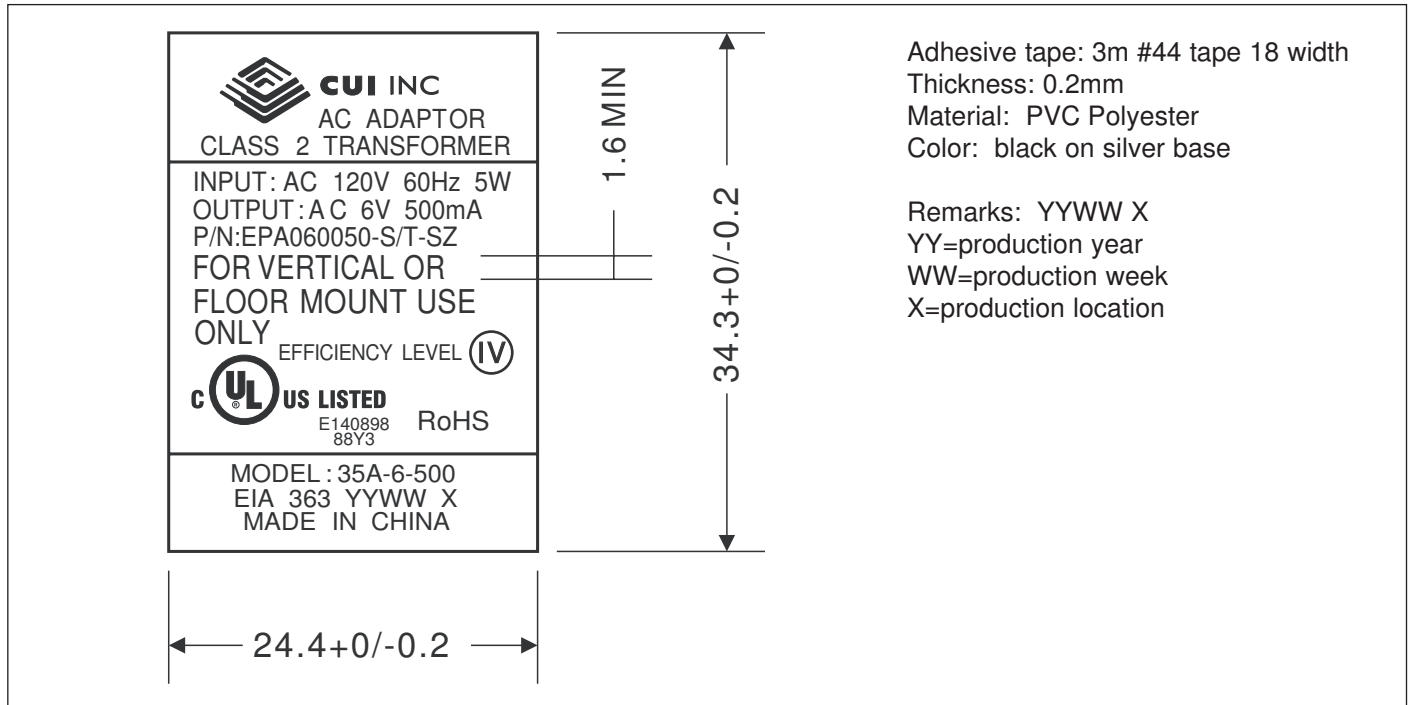



### Mechanical Drawing

Tolerance:  $\pm 1$

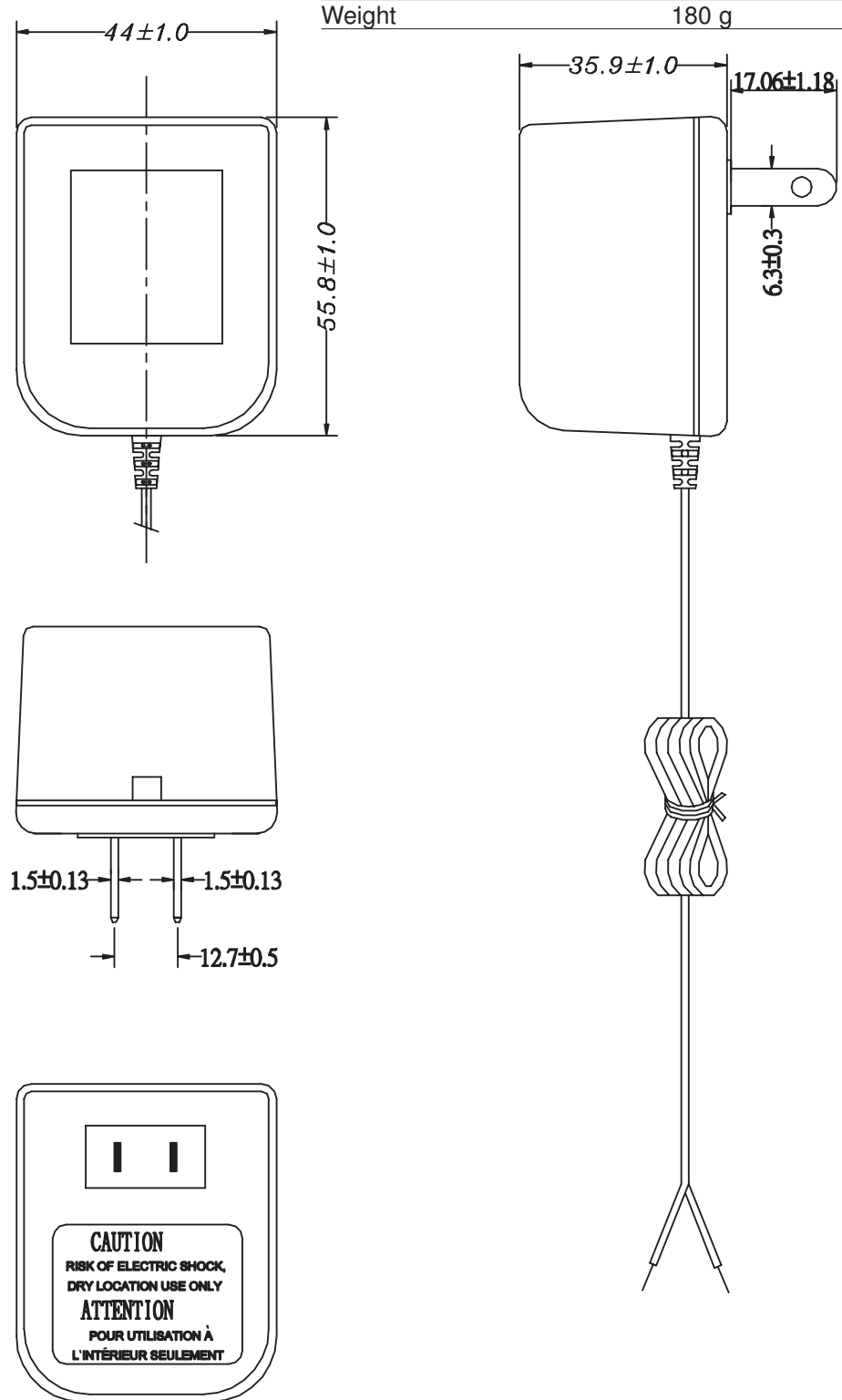



**DC Cord**

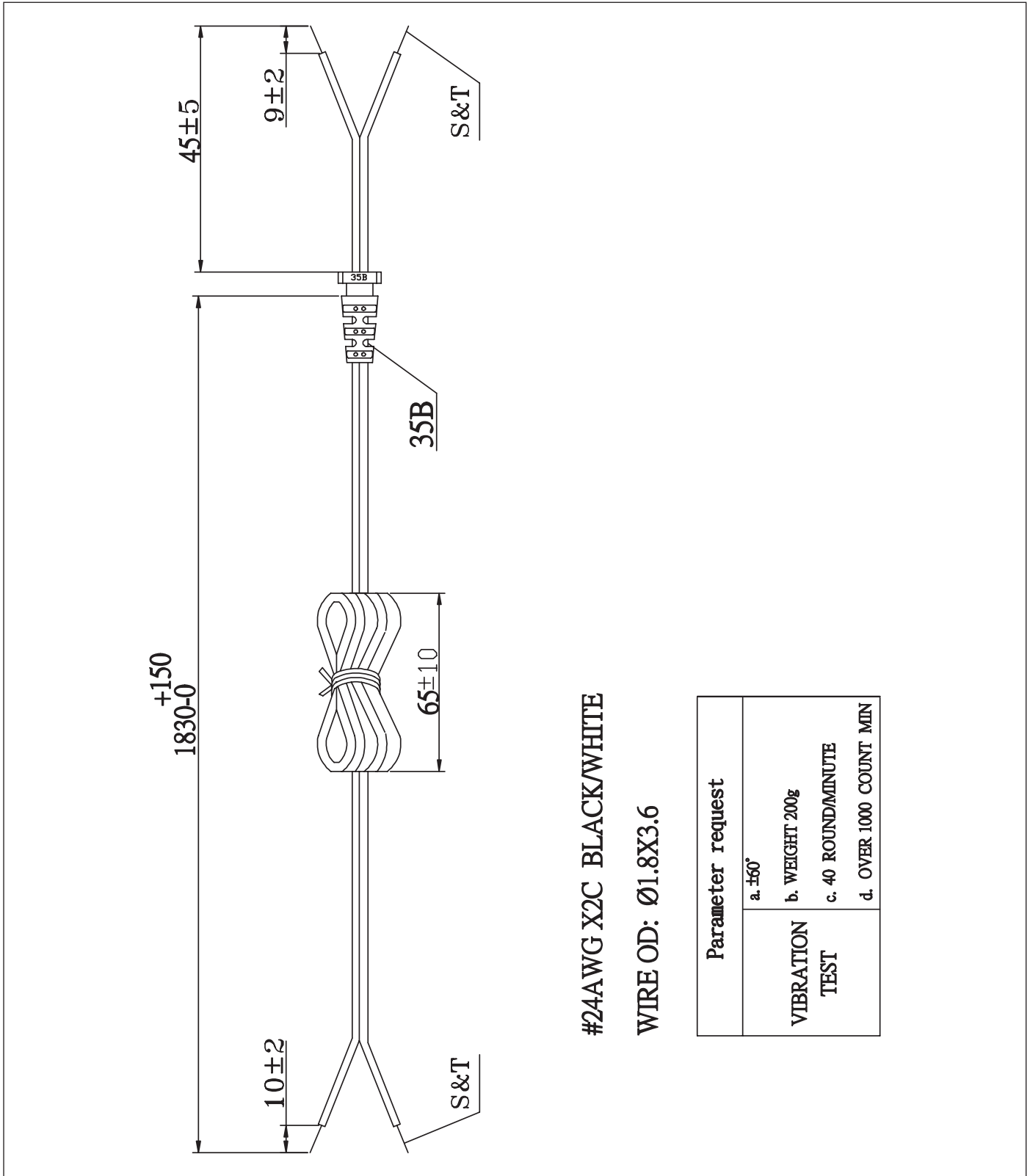

**#24AWG X2C BLACK/WHITE**

**WIRE OD: Ø1.8X3.6**

Parameter request	
VIBRATION TEST	a. ±60°
	b. WEIGHT 200g
	c. 40 ROUND/MINUTE
	d. OVER 1000 COUNT MIN

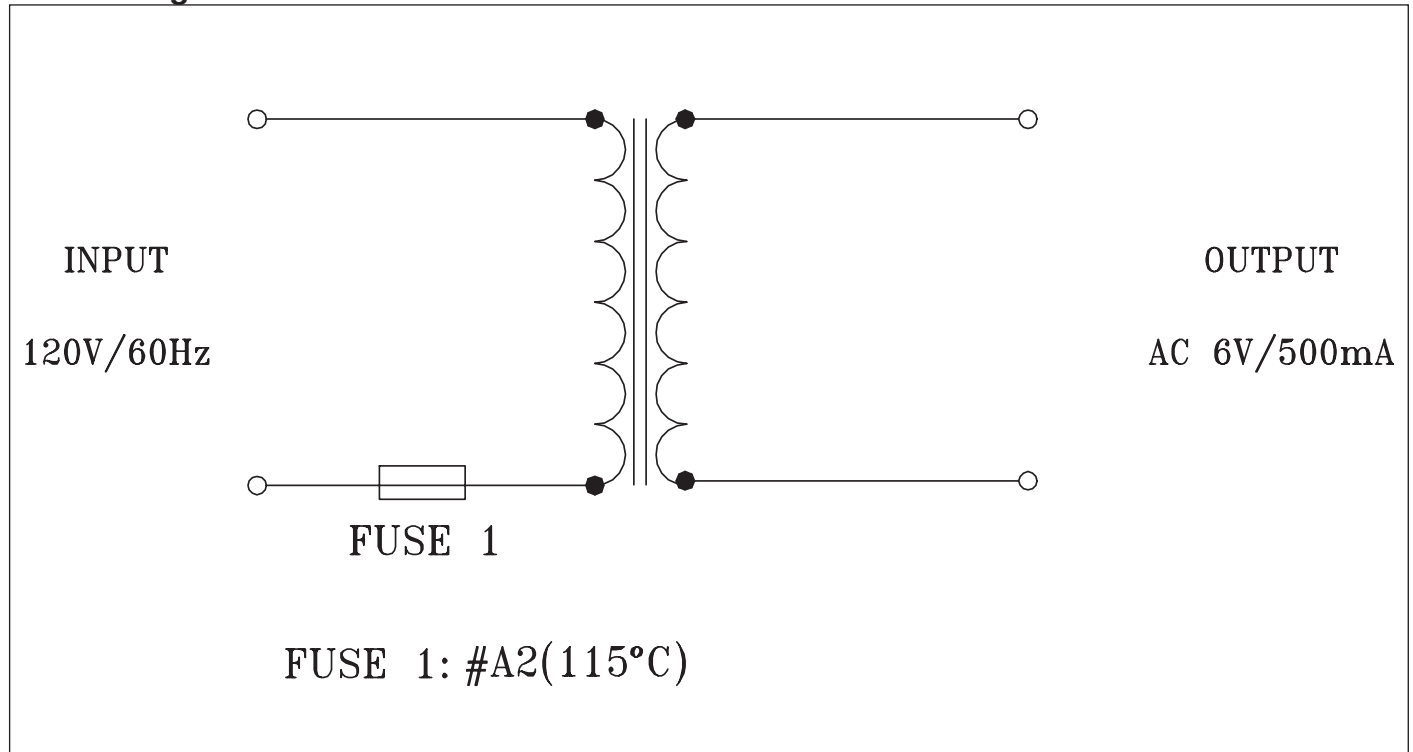
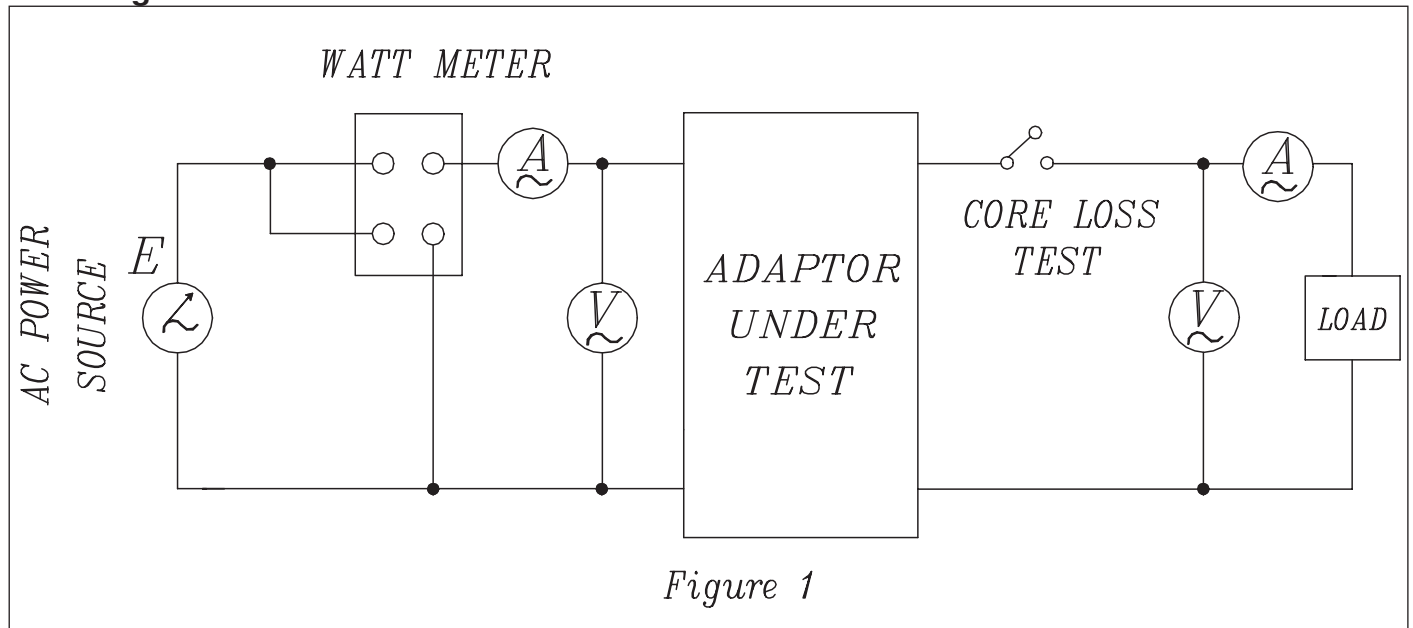
**Circuit Diagrams**

**Test Diagram**



**CUI INC**

Part No: EPA060050-S/T-SZ

Description: linear power supply

Date: 5/11/2007

Unit: mm

Page No: 6 of 7

### Individual Packaging

Tolerance:  $\pm 1$

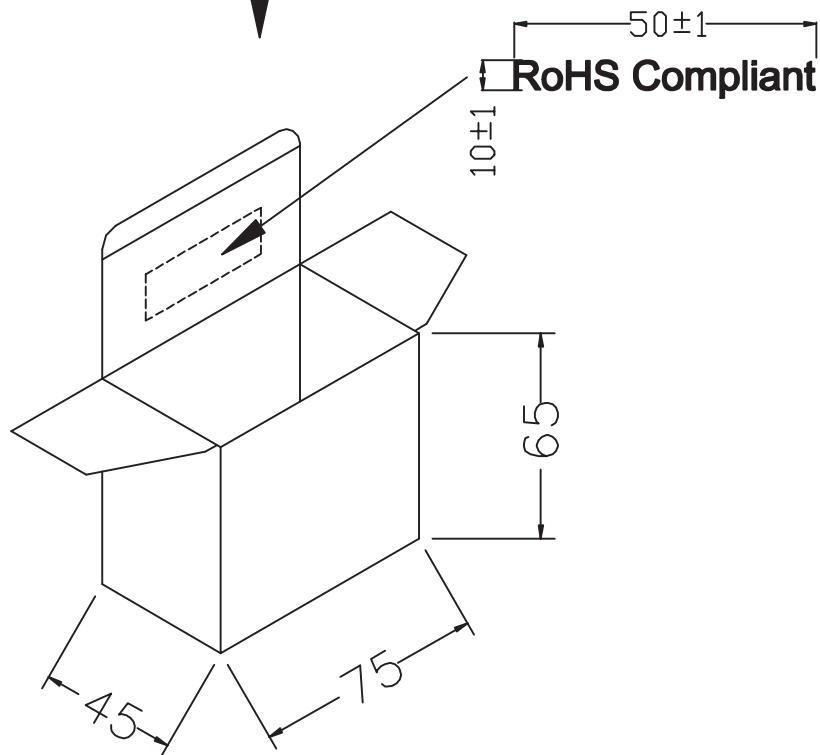
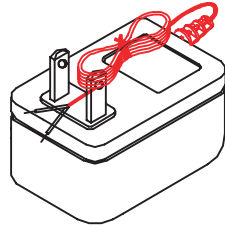



**Packaging**

Tolerance: +7/-0

OUTSIDE CARTON:A=B(6mm)  
INSIDE CARTON:A-B(3mm)  
CARTON SIZE: 402X352X125mm  
Q'TY: 50pcs(25X2)  
N.W: 9 KGS  
G.W: 10 KGS  
G.W: 11 KGS

