

### TEST DATA

ITEM	SPEC	SAMPLE									
		1	2	3	4	5	6	7	8	9	10
Primary Exciting Current Input 120 VAC , 60Hz	50 mA max	25	25	22							
Primary Load Current Input 120VAC , 60 Hz	75 mA max	66	66	68							
Secondary No Load DC Voltage	19V ±5%	18.9	18.89	18.87							
Secondary DC Voltage Load 300 mA	12V ±5%	11.8	11.85	11.8							
Secondary Voltage Load mA	V ± %										
Secondary Voltage Load mA	V ± %										
Secondary Voltage Load mA	V ± %										
Secondary Voltage Load mA	V ± %										
Ripple Voltage Load 300 mA (PK-PK)	2.0V max	1.2	1.2	1.2							
Hi-Pot Test 3 mA for 3Sec.	Pri. to Sec.	2K VAC	OK	OK	OK						
	Pri. to Core	2K VAC	OK	OK	OK						
	Sec. to Core	1.5K VAC	OK	OK	OK						
Temperature Rise: 70°C MAX measured By Resistance Method (Primary Winding)											
Core Film: SPLIT						Core : EI-35					
Testing Circuit:		1000uF/25V				Output Plug Drawing: PLUG: 4.0*1.7mm					
											
Output conductor length: 6FT min (AWG#24 )											
Input conductor length: ft min (AWG# )											
(V) <b>Characteristic Curve</b>											
											

## AC Adaptor Specifications

### Internal Construction Drawing and Parts List (Unit: Set or EA)

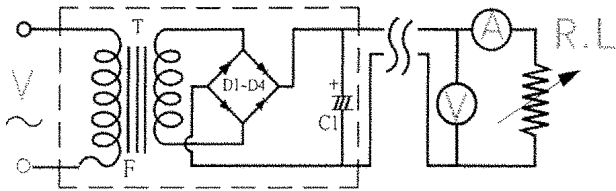
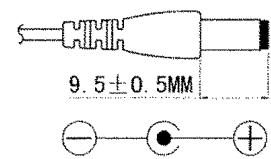
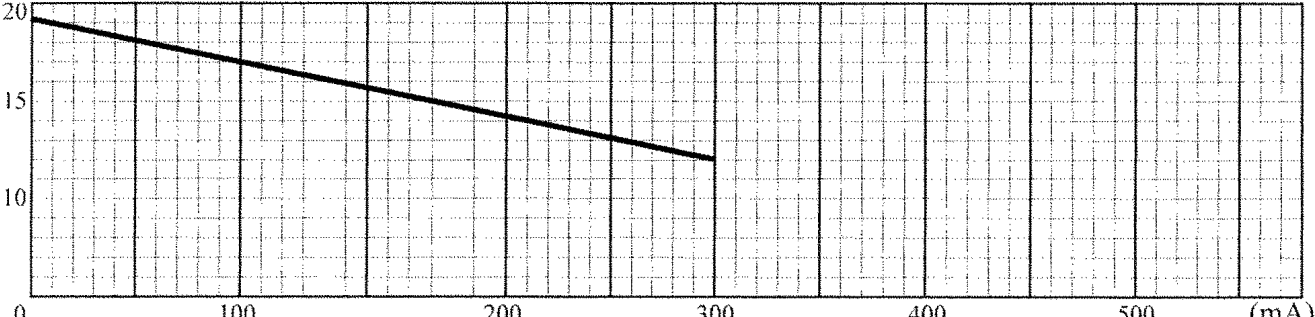
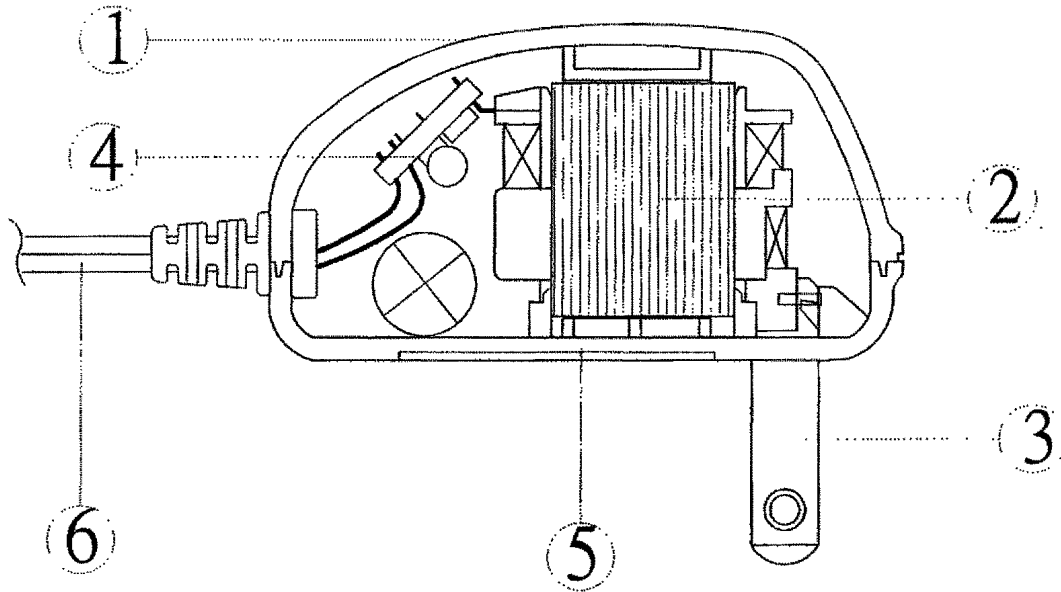

Part Name	Specification	Q'ty
1. Enclosure	Noryl SE1 94V-0 105°C	
	Noryl SE-100 94V-0 95°C	
	Noryl PX1700 94V-0 95°C	
	940(f1) 94V-0 130°C	
2. Transformer	EI-35	1
3. Blade	Ni plated brass	2
<b>4. Print Wiring Board Assembly</b>		
Print Wiring Board	04V0 94V-0 130°C	1
	11 94V-0 105°C	
	13 94V-0 130°C	
	BF-3 94V-0 130°C	
Diode	1A 400-700V IN4004-IN4007	4
Capacitor	1000uf 25V 85°C	1
5. Name Plate	Polyester Film	1
6. Output Cord	AWG# 24 6FT min	1

## DC Adaptor Specifications

---

### Construction Drawing and Details of Transformer

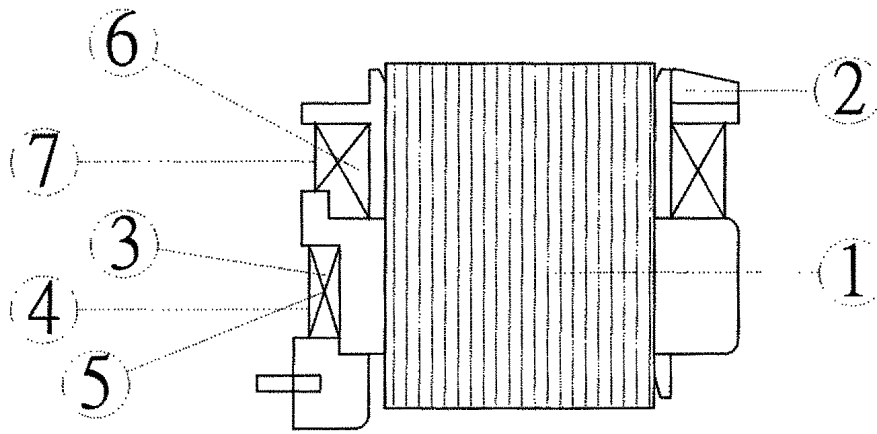

Part Name	Material & Type	Spec or Q'ty
1. Core	Silicon Steel	0.5mm
2. Bobbin	Polybutylene Terephthalate	0.71mm
	1403G6	
	PETP(QMFZ2)	
	FR-530, FR530L	
3. Primary Winding	Polyurethane Enameled	mm turn ohm
	Copper wire	
4. Primary Outer Winding	Mylar Tape	0.025mmx2T
5. Thermal Fuse	M30 2A 125°C 250V AC	1PC
6. Secondary Winding	Polyurethane Enameled	mm turn ohm
	Copper Wire	
7. Secondary Outer Winding	Mylar Tape	0.025mmx2T

## DC Adaptor Specifications

---

### Circuit Diagram

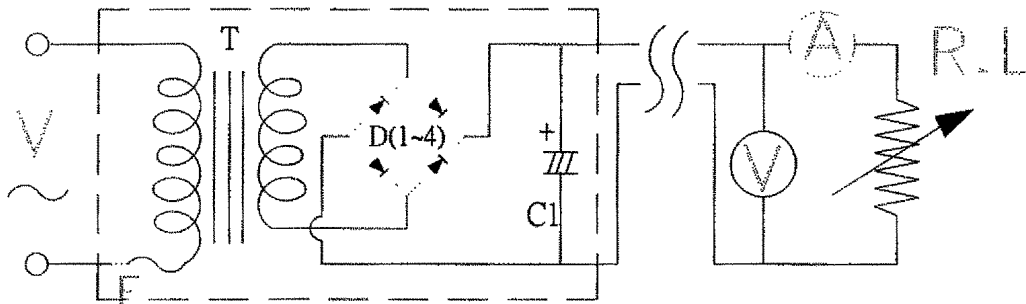

Symbol	Part Name	Note
T	Transformer	EI-35
D(1~4)	Diode	1A 400-700V IN4004-IN4007
F	Thermal	125°C 2A 250V
C1	Capacitor	1000uF 25V 85°C

## AC Adaptor Specifications

### Appearance Drawing (Unit:mm)

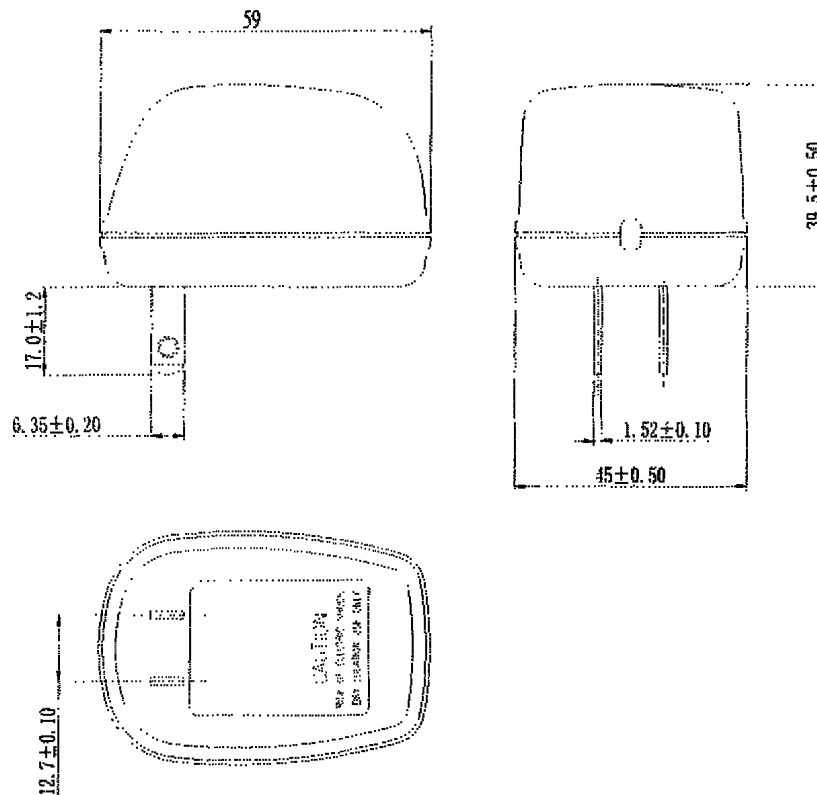

## DC Adaptor Specifications

### Dimension of Nameplate (Unit:mm)

C2X45°

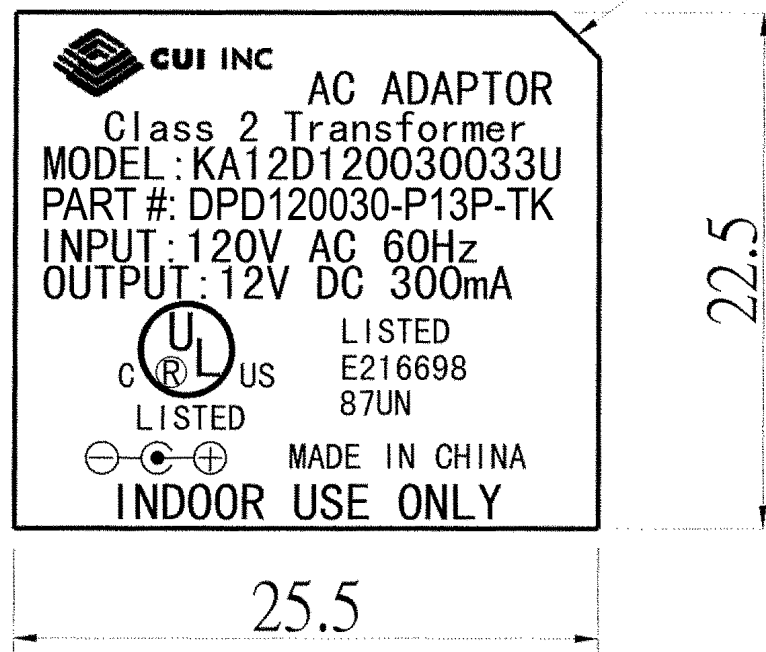

Material: Polyester Film

T: 0.25mm