

PART NUMBER: ETS240050SUDC-P5P-KH

DESCRIPTION: switching adapter

INPUT

rated input voltage	100 V ~ 240 V ac
input voltage range	90 V ~ 264 V ac
rated frequency	50~60 Hz
frequency range	47~63 Hz
rated input current	350 mA max.
inrush current	50 A max. (actual test result is 13.2 A)

OUTPUT

output voltage	24 V dc at 0.5 A
output min. current	0 A
line regulation	± 2% max.
load regulation	± 5% max.
over voltage protection	30 V ±1 V
short circuit protection	auto recovery
ripple voltage	240 mV max. (at 20 MHz bandwidth with 22µF/50V capacitance and 104/50V ceramic capacitor)
efficiency	meets Energy Star / CEC Level IV

SAFETY & EMI

HI-POT	input to output	3000 V ac at 4 mA for 2 seconds
	input to case	3000 V ac at 4 mA for 2 seconds
insulation resistance	input to output	50MΩ at 500 V dc
safety approvals	UL60950-1 (first edition), CAN/CSA-C22.2 No.950-95, IEC60950-1: 2001, EN60950-1: 2001	
EMI standard	FCC part 15 class B, EN55022 (EN61000-3-2, 3), EN55024 (IEC61000-4-2, 3, 4, 6, 8, 11)	
RoHS compliant	yes	

ENVIRONMENTAL

storage temperature	-20°C ~ +70° C
operating temperature	0°C ~ +40° C
storage humidity	10~95%
operating humidity	10~95%

RELIABILITY

MTBF	50000 hours at 25°C
burn-in	2 hours at 40°C and full load

PART NUMBER: ETS240050SUDC-P5P-KH

DESCRIPTION: switching adapter

LABEL

0.2mm NAME-PLATE:SILVER CHARACTERS BLACK BACKGROUND.

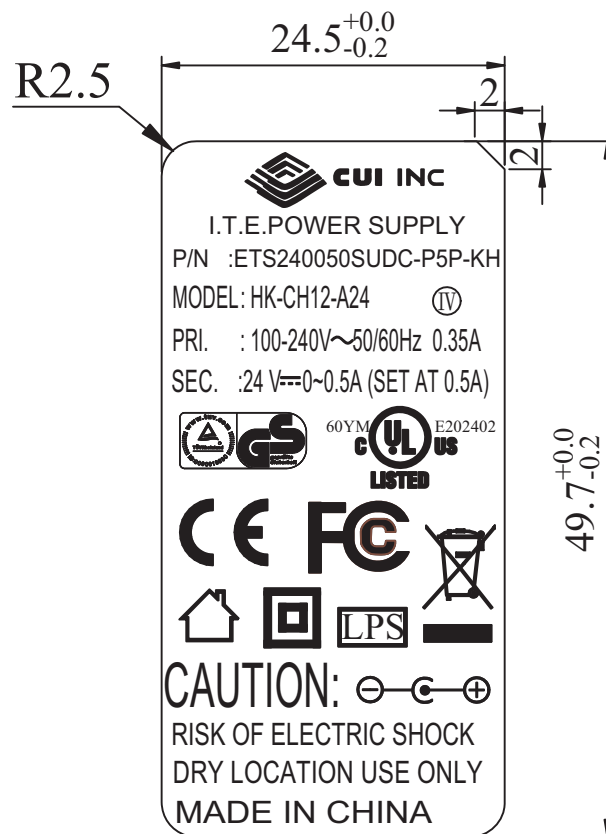

PART NUMBER: ETS240050SUDC-P5P-KH

DESCRIPTION: switching adapter

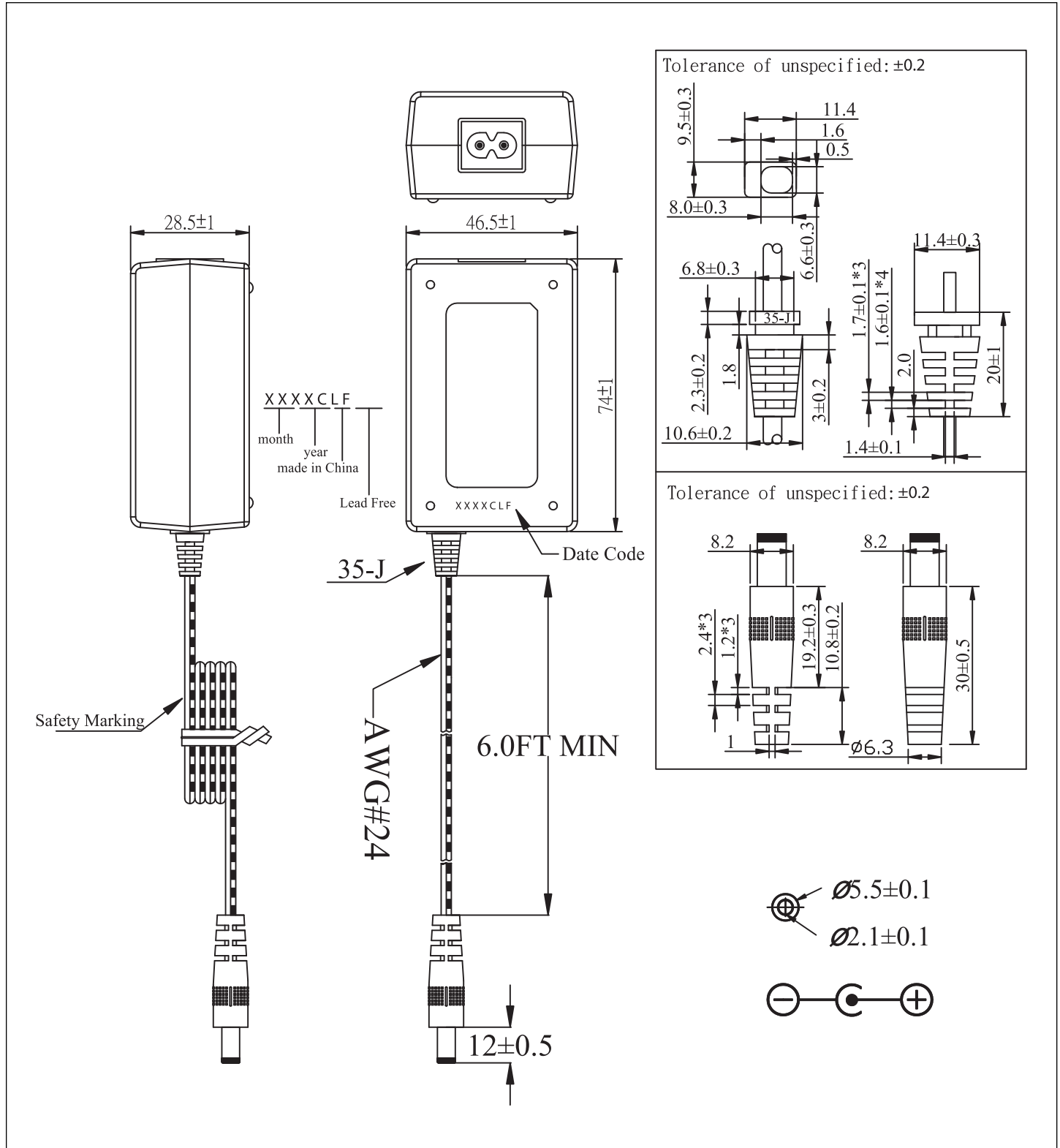
MECHANICAL DRAWING

PART NUMBER: ETS240050SUDC-P5P-KH

DESCRIPTION: switching adapter

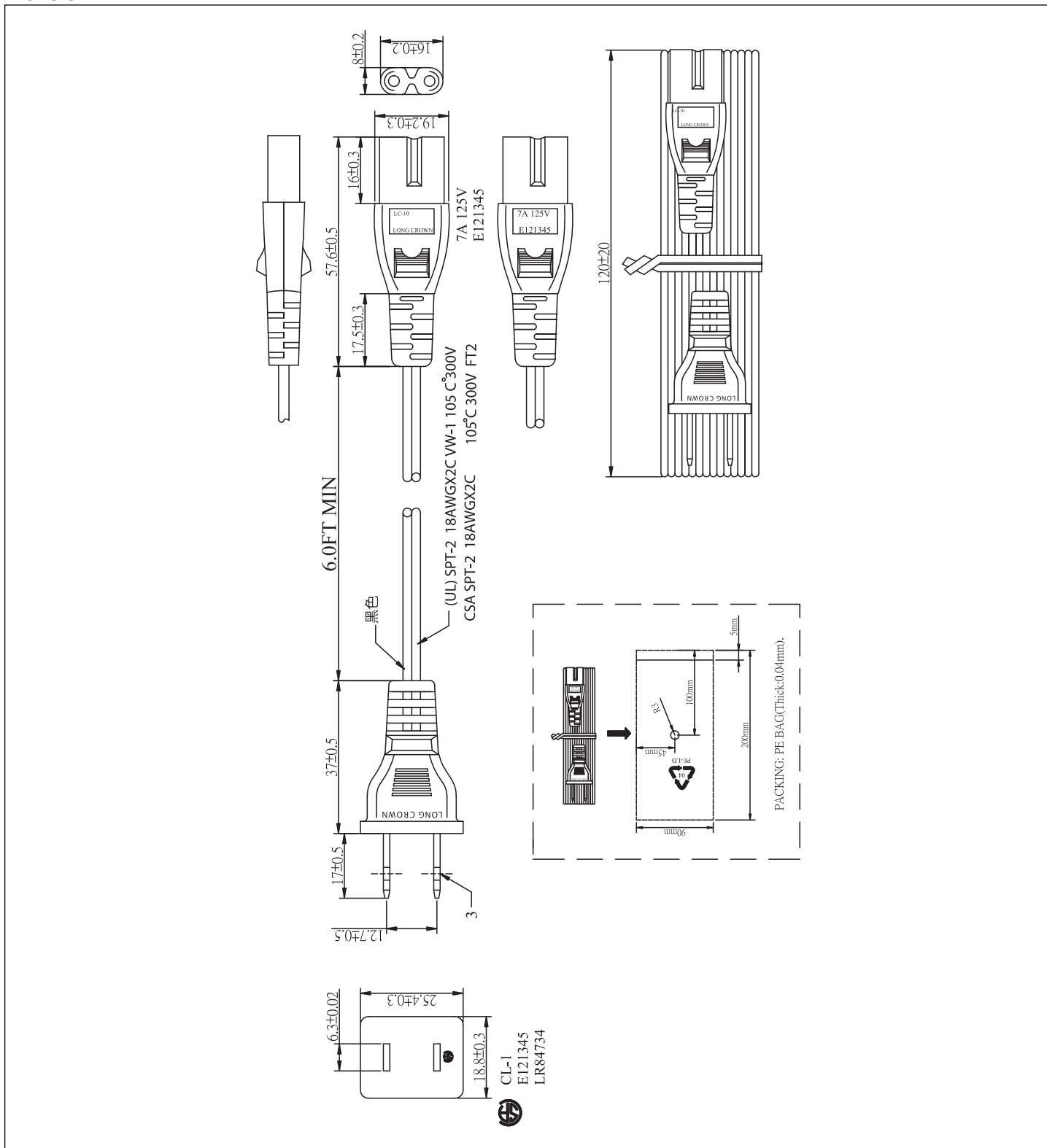
AC CORD

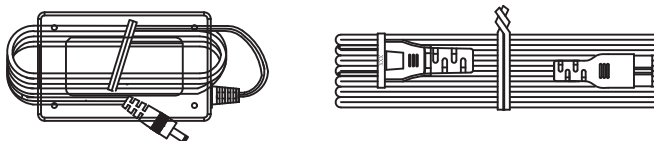
PART NUMBER: ETS240050SUDC-P5P-KH**DESCRIPTION:** switching adapter**INDIVIDUAL PACKAGING**

BUBBLE BAG

Length : 150

Width : 120

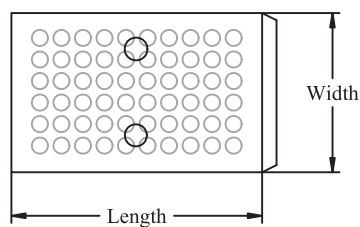

BOX

Length: 128

Width: 60

Height: 60

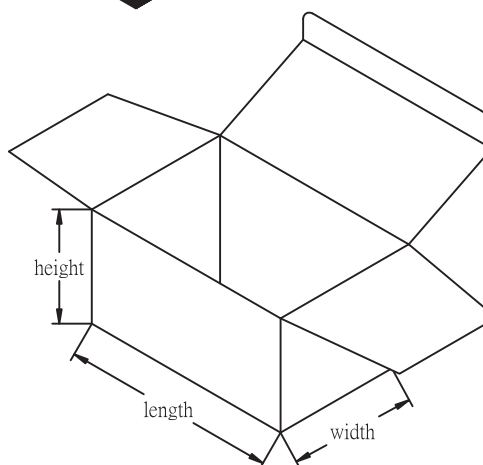

PART NUMBER: ETS240050SUDC-P5P-KH

DESCRIPTION: switching adapter

PACKAGING

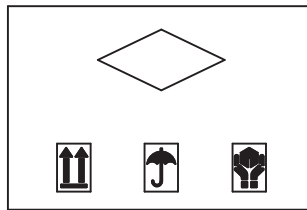

MODEL:
N.W.:
G.W.:
Q'TY: 75PCS

	100V~120V
	200V~240V
	100V~240V

