

Part I – AC-to-DC Power Supplies

LAMBDA'S LFS SERIES

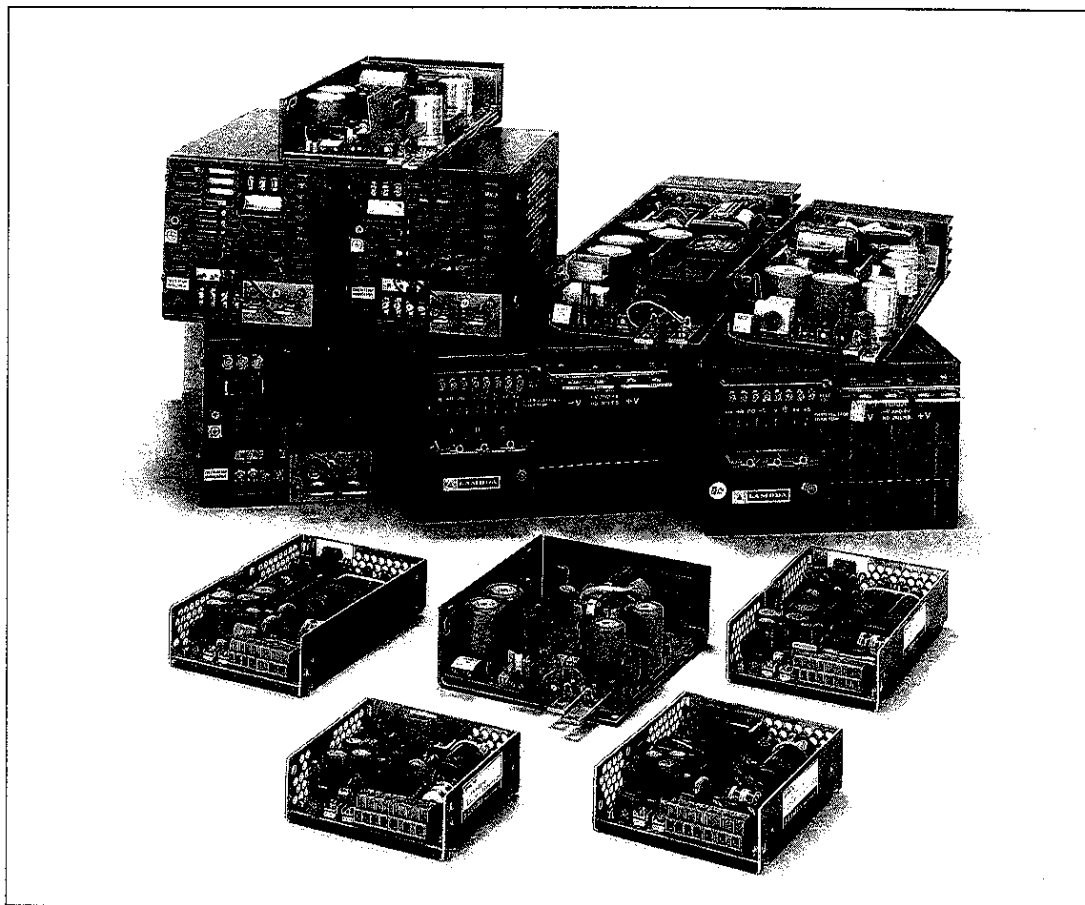

Industrial Grade Switching For Worldwide Applications

Reliability starts with the design, and the LFS Series incorporates a unique control concept developed by Lambda which provides inherently reliable operation in transient line and load conditions.

The LFS Series is available in 14 package sizes from 2V to 48V, up to 6000W, up to 1100A with power densities up to 10W/in³. All models include remote sense, remote programming and remote turn-on/turn-off as well as built-in protection from short circuit, overvoltage and fan failure conditions. User selectable AC input and international safety agency approvals (on most models) ensure worldwide operation. The 1500W, 2000W and 6000W packages incorporate parallel current sharing circuitry with automatic temperature compensation for increased reliability.

Their unique design approach coupled with their controlled manufacturing and quality standards, makes the LFS Series the ideal choice for demanding industrial applications.

LFS SERIES SPECIFICATIONS

AC Input

line +.95 to 132VAC / 187 to 265VAC, 47-440Hz.
 85 to 132VAC / 170 to 265VAC, 47-440Hz on
 LFS-41, 42 (user selectable). 85 to 265 VAC,
 47-440Hz on LFS-38, 39, 40 (wide range
 input, no tap change). 170 to 265VAC,
 47-440Hz single phase or three phase on
 LFS-49 and LFS-50. 170 to 265VAC three
 phase on LFS-52.

Package Model	Maximum Input Power (W)	Maximum Input Current (A RMS)
LFS-38	31.5	0.4
LFS-39	45	0.8
LFS-40	89.5	1.5
LFS-41	120	2.0
LFS-42	186	3.7
LFS-43	326	5.7
LFS-44	440	7.5
LFS-45, 45A	682	12.0
LFS-46	882	15.0
LFS-47	1103	18.0
LFS-48	1470	25.0
LFS-49	2457	22.0 (1Ø) 16.0 (3Ø)
LFS-50	3220	30.0 (1Ø) 20.0 (3Ø)
LFS-52	8000	30.0 (3Ø)

Efficiency

40% minimum on 2V model of LFS-38. 45% minimum on 2V models of LFS-39, 40, 41. 55% minimum on all other 2V models. 60% minimum on 5V and 6V models of LFS-38. 67% minimum on 5V and 6V models of LFS-39, 40. 68% minimum on 12V through 20V models of LFS-38. 70% minimum on 12V through 20V models of LFS-39 and LFS-52-2. 71% minimum on 24V through 48V models of LFS-39. 72% minimum on 5V through 15V models of LFS-42. 73% minimum on 12V through 20V models of LFS-40. 74% minimum on 24V through 48V models of LFS-38, 40. 75% minimum on 5V through 15V models of LFS-41, 42, 43, 44, 45, 45A, 46, 47, 48, 49, 50 and LFS-52-5. 78% minimum on 20V through 48V models of LFS-41. 80% minimum on all 20V through 48V models of LFS-42, 43, 44, 45, 45A, 46, 47, 48, 49, 50 and LFS-52-8.

DC Input

110 to 370VDC on LFS-38, 39, 40. 230 to 370VDC on LFS-41. 260 to 370VDC on LFS-42, 43, 44, 45, 45A, 46, 47, 48 (unit must be wired for 220V configuration). 240 to 370VDC on LFS-49, 50, 52.

DC Output

Voltage range shown in tables.

Regulated Voltage

regulation, line01% from low line to high line and high line to low line.
 regulation, load01% from 0 to full load.
 ripple and noise 15mV RMS, 75mV pk-pk for 2V, 5V and 6V models and all models of LFS-52.
 20mV RMS, 150mV pk-pk for 12V through 28V models.
 35mV RMS, 200mV pk-pk for 48V models.
 temperature coefficient 0.03%/°C.
 remote programming resistance . . . 1000Ω/V nominal.
 remote programming voltage volt per volt.

Hold Up Time

2V, 5V and 6V models will remain within regulation limits for at least 16.7 msec. after loss of AC power when operating at full load, V_o max and 105VAC input at 60Hz. 100 msec hold up when operating at maximum output power and 210VAC input at 50Hz on LFS-38, 39, 40 and 41. (When configured at 220V input: 20 msec hold up when operating at maximum output power and 210VAC input at 50Hz.)

Overcurrent Protection

Current limiting with automatic reset.

Overvoltage Protection

Non-crowbar, inverter shutdown type OV protection is standard on all models.

In-Rush Current Limiting

All models are provided with in-rush current limiting to limit the current to a preset value.

Overshoot

No overshoot at turn-on, turn-off or power failure.

Remote Turn-On/Turn-Off

TTL compatible voltage level signal enables remote turn-on/turn-off of the power supply. A voltage of 2.8V to 5.0V applied to remote on/off terminals will initiate turn-off. Open circuit or short circuit condition, or a zero to .5V signal will cause turn-on. On the LFS-52, positive or negative logic on/off capability is provided.

Remote Sensing

Provision is made for remote sensing to eliminate the effects of power output lead resistance on DC regulation.

Isolation Rating

3000VAC input to output and input to ground on LFS-52. 1500VAC input to output and 1500VAC input to ground on other models. 500VAC output to ground on all models.

Current Sharing

The LFS-49, LFS-50, and LFS-52 can be operated in current sharing parallel. The hottest unit will automatically supply less load current. A single additional connection must be run between the supplies. This connection is available on the terminal block.

Cooling

LFS-38, 39, 40, 41, 42, 43, 44, 45 are convection cooled. LFS-45A, 46, 47, 48, 49, 50, 52 are fan cooled.

Operating Temperature Range

Continuous duty 0°C to 60°C (-10°C to 60°C for the LFS-52) with suitable derating above 40°C. Guaranteed turn-on at -10°C (-20°C for the LFS-52) with reduced specifications.

Output Current Monitor

A 0 to 2.5VDC signal which is proportional to the output current is provided on the signal connector of the LFS-52.

Power Good Indicator

An open collector DC power fail signal is provided on the LFS-52. An LED will also light in the event of an overvoltage, overtemperature, output power or switching module failure.

DC Output Controls

Screwdriver adjustment over the entire voltage range.

Input and Output Connections

All input, sensing and remote on/off connections are made via PC board mounted terminal block. DC output connections are made via heavy duty bus bars (LFS-38, 39, 40, 41 are PC board mounted terminals). Ground connections are made via chassis stud.

Mounting

One mounting surface and one mounting position on LFS-38, 39, 40, 41, 42, 43, 44, 45. One mounting surface, multiple mounting positions on LFS-45A, 46, 47, 48, 49, 50, 52.

Finish

Gray, Fed. Std. 595, No. 26081.

Accessories

For rack adapters, and other accessories, see Page 152 of this catalog.

Physical Data

Package Model	Lbs. Net	Lbs. Ship	Size Inches
LFS-38	0.58	1.58	1.38 × 3.82 × 3.54
LFS-39	0.74	1.74	1.38 × 3.82 × 4.53
LFS-40	1.03	2.03	1.46 × 3.82 × 6.02
LFS-41	1.25	2.25	1.78 × 3.82 × 6.30
LFS-42	1.30	2.30	1.9 × 4.75 × 5.687
LFS-43	3.00	4.00	1.9 × 4.75 × 9.125
LFS-44	3.50	4.50	1.9 × 4.75 × 11.75
LFS-45	6.00	7.00	1.9 × 4.75 × 16
LFS-45A	6.00	7.00	4 × 4 × 9
LFS-46	8.75	11.75	5 × 4.875 × 7.25
LFS-47	9.19	12.19	5 × 4.875 × 8.875
LFS-48	12.31	15.31	5 × 4.875 × 11
LFS-49	16.00	19.00	7.375 × 4.875 × 11.50
LFS-50	18.00	21.00	7.375 × 4.875 × 12.875
LFS-52	31.00	35.00	5 × 8 × 16

Safety Agency Approvals

All models are UL recognized, TUV licensed, and CSA certified.

Guaranteed for 3 Years

Three year guarantee includes labor as well as parts. Guarantee applies to operation at full published specifications at the end of three years.

Industrial Ratings Table – Single Output

LFS SERIES

- Highest Density to 10W/in²
- Most Cost Effective Industrial Solution
- Current Sharing Above 1000W

RWS SERIES

- IEC 555-2 Compliant
- PFC to 0.95
- Universal Inputs

EWS SERIES

- FCC Class A EMI
- Current Sharing Above 150W
- Wide Range or Auto-Select Input

MAX CURRENT (AMPS) AT AMBIENT TEMPERATURE OF			V _{out} ADJ. RANGE	COMPLETE ELEC. SPEC. PG.	1	UNIT PRICE PER DELIVERED QUANTITY			MODEL
40°C	50°C	60°C				10	25	100	
2V OUTPUT									
1100.00	1000.00	931.00	1.80-3.30	29	2884	2755	–	–	LFS-52-2
3.3V OUTPUT									
1100.00	1000.00	931.00	1.80-3.30	29	2884	2755	–	–	LFS-52-2
5V OUTPUT									
3.80	2.60	1.90	4.75-5.25	29	91	87	81	71	LFS-38-5
6.00	4.20	3.00	4.75-5.25	29	122	116	111	90	LFS-39-5
12.00	8.40	6.00	4.75-5.25	29	173	166	159	129	LFS-40-5
18.00	12.60	9.00	4.75-5.25	29	231	219	210	166	LFS-41-5
25.00	21.80	17.30	4.75-5.25	29	291	279	267	191	LFS-42-5
40.00	33.50	25.00	4.75-5.25	29	348	332	317	255	LFS-43-5
60.00	45.00	33.50	4.75-5.25	29	447	426	409	333	LFS-44-5
90.00	67.50	45.00	4.75-5.25	29	595	568	544	440	LFS-45-5
90.00	67.50	45.00	4.75-5.25	29	595	568	544	440	LFS-45A-5
120.00	112.00	93.50	4.75-5.25	29	719	686	658	505	LFS-46-5
150.00	142.50	120.00	4.75-5.25	29	845	804	773	629	LFS-47-5
200.00	185.00	157.00	4.75-5.25	29	992	946	906	763	LFS-48-5
300.00	285.00	261.00	4.75-5.25	39	1352	1289	1237	1010	LFS-49-5
400.00	375.00	350.00	4.75-5.25	29	1613	1537	1474	1234	LFS-50-5
1000.00	930.00	850.00	4.50-6.00	29	2884	2755	–	–	LFS-52-5
6V OUTPUT									
800.00	750.00	650.00	5.50-8.00	29	2884	2755	–	–	LFS-52-8

Industrial Ratings Table – Single Output

LFS SERIES

- Highest Density to 10W/in³
- Most Cost Effective Industrial Solution
- Current Sharing Above 1000W

RWS SERIES

- IEC 555-2 Compliant
- PFC to 0.95
- Universal Inputs

EWS SERIES

- FCC Class A EMI
- Current Sharing Above 150W
- Wide Range or Auto-Select Input

MAX CURRENT (AMPS) AT AMBIENT TEMPERATURE OF			V _{out} ADJ. RANGE	COMPLETE ELEC. SPEC. PG.	1	UNIT PRICE PER DELIVERED QUANTITY			MODEL
40°C	50°C	60°C				10	25	100	
12V OUTPUT									
1.60	1.10	0.80	11.40-12.60	29	91	87	81	71	LFS-38-12
2.50	1.80	1.30	11.40-12.60	29	122	116	111	90	LFS-39-12
5.00	3.50	2.50	11.40-12.60	29	173	166	159	129	LFS-40-12
7.50	5.20	3.70	11.40-12.60	29	231	219	210	166	LFS-41-12
10.50	9.50	8.00	11.40-12.60	29	291	279	267	191	LFS-42-12
19.00	15.00	11.00	11.40-12.60	29	348	332	317	255	LFS-43-12
26.00	18.50	13.50	11.40-12.60	29	447	426	409	333	LFS-44-12
40.00	30.00	20.00	11.40-12.60	29	595	568	544	440	LFS-45-12
40.00	30.00	20.00	11.40-12.60	29	595	568	544	440	LFS-45A-12
51.50	48.00	40.00	11.40-12.60	29	719	686	658	505	LFS-46-12
64.50	61.50	55.00	11.40-12.60	29	845	804	773	629	LFS-47-12
86.00	79.50	67.50	11.40-12.60	29	992	946	906	763	LFS-48-12
145.00	138.00	126.00	11.40-12.60	29	1352	1289	1237	1010	LFS-49-12
190.00	180.00	170.00	11.40-12.60	29	1613	1537	1474	1234	LFS-50-12
15V OUTPUT									
1.30	0.90	0.65	14.25-15.75	29	91	87	81	71	LFS-38-15
2.00	1.40	1.00	14.25-15.75	29	122	116	111	90	LFS-39-15
4.00	2.80	2.00	14.25-15.75	29	173	166	159	129	LFS-40-15
6.00	4.20	3.00	14.25-15.75	29	231	219	210	166	LFS-41-15
8.50	7.50	6.30	14.25-15.75	29	291	279	267	191	LFS-42-15
15.00	12.00	9.00	14.25-15.75	29	348	332	317	255	LFS-43-15
15.00	12.00	9.00	14.25-15.75	29	348	332	317	255	LFS-43-15
21.00	15.50	11.50	14.25-15.75	29	447	426	409	333	LFS-44-15
32.50	24.50	16.00	14.25-15.75	29	595	568	544	440	LFS-45-15
32.50	24.50	16.00	14.25-15.75	29	595	568	544	440	LFS-45A-15
42.00	39.00	33.00	14.25-15.75	29	719	686	658	505	LFS-46-15
52.50	50.00	44.50	14.25-15.75	29	845	804	773	629	LFS-47-15
70.00	64.50	55.00	14.25-15.75	29	992	946	906	763	LFS-48-15
115.00	108.00	100.00	14.25-15.75	29	1352	1289	1237	1010	LFS-49-15
153.00	143.00	133.00	14.25-15.75	29	1613	1537	1474	1234	LFS-50-15

100% Satisfaction Guarantee
 30 Day Return Policy

Industrial Ratings Table – Single Output

LFS SERIES

- Highest Density to 10W/in³
- Most Cost Effective Industrial Solution
- Current Sharing Above 1000W

RWS SERIES

- IEC 555-2 Compliant
- PFC to 0.95
- Universal Inputs

EWS SERIES

- FCC Class A EMI
- Current Sharing Above 150W
- Wide Range or Auto-Select Input

MAX CURRENT (AMPS) AT AMBIENT TEMPERATURE OF			V _{out} ADJ. RANGE	COMPLETE ELEC. SPEC. PG.	UNIT PRICE PER DELIVERED QUANTITY				MODEL
40°C	50°C	60°C			1	10	25	100	
24V OUTPUT									
0.70	0.70	0.35	21.60-26.40	39					
0.80	0.55	0.40	22.80-25.20	29	91	87	81	71	LFS-38-24
1.30	0.90	0.65	22.80-25.20	29	122	116	111	90	LFS-39-24
2.50	1.75	1.25	22.80-25.20	29	173	166	159	129	LFS-40-24
3.80	2.60	1.90	22.80-25.20	29	231	219	210	166	LFS-41-24
5.70	5.10	4.30	22.80-25.20	29	291	279	267	191	LFS-42-24
10.00	7.80	5.70	22.80-25.20	29	348	332	317	255	LFS-43-24
13.00	10.00	7.50	22.80-25.20	29	447	426	409	333	LFS-44-24
20.00	15.00	10.00	22.80-25.20	29	595	568	544	440	LFS-45-24
20.00	15.00	10.00	22.80-25.20	29	595	568	544	440	LFS-45A-24
27.00	25.00	21.00	22.80-25.20	29	719	686	658	505	LFS-46-24
33.50	32.00	28.50	22.80-25.20	29	845	804	773	629	LFS-47-24
44.50	40.50	35.00	22.80-25.20	29	992	946	906	763	LFS-48-24
72.00	68.00	63.00	22.80-25.20	29	1352	1289	1237	1010	LFS-49-24
97.00	90.00	84.00	22.80-25.20	29	1613	1537	1474	1234	LFS-50-24
28V OUTPUT									
0.70	0.50	0.35	26.60-29.40	29	91	87	81	71	LFS-38-28
1.10	0.77	0.55	26.60-29.40	29	122	116	111	90	LFS-39-28
2.20	1.50	1.10	26.60-29.40	29	173	166	159	129	LFS-40-28
3.30	2.30	1.60	26.60-29.40	29	231	219	210	166	LFS-41-28
5.00	4.40	3.70	26.60-29.40	29	291	279	267	191	LFS-42-28
8.60	6.80	5.00	26.60-29.40	29	348	332	317	255	LFS-43-28
11.50	8.50	6.30	26.60-29.40	29	447	426	409	333	LFS-44-28
17.50	13.00	8.50	26.60-29.40	29	595	568	544	440	LFS-45-28
17.50	13.00	8.50	26.60-29.40	29	595	568	544	440	LFS-45A-28
23.00	21.50	18.00	26.60-29.40	29	719	686	658	505	LFS-46-28
29.00	27.50	24.50	26.60-29.40	29	845	804	773	629	LFS-47-28
38.50	35.00	30.00	26.60-29.40	29	992	946	906	763	LFS-48-28
64.00	61.00	56.00	26.60-29.40	29	1352	1289	1237	1010	LFS-49-28
86.00	80.00	75.00	26.60-29.40	29	1613	1537	1474	1234	LFS-50-28

Industrial Ratings Table – Single Output

LFS SERIES

- Highest Density to 10W/in³
- Most Cost Effective Industrial Solution
- Current Sharing Above 1000W

RWS SERIES

- IEC 555-2 Compliant
- PFC to 0.95
- Universal Inputs

EWS SERIES

- FCC Class A EMI
- Current Sharing Above 150W
- Wide Range or Auto-Select Input

MAX CURRENT (AMPS) AT AMBIENT TEMPERATURE OF			V _{out} ADJ. RANGE	COMPLETE ELEC. SPEC. PG.	UNIT PRICE PER DELIVERED QUANTITY				MODEL
40°C	50°C	60°C			1	10	25	100	
48V OUTPUT									
0.40	0.28	0.20	45.60-50.40	29	\$ 91	\$ 87	\$ 81	\$ 71	LFS-38-48
0.65	0.45	0.32	45.60-50.40	29	122	116	111	90	LFS-39-48
1.25	0.87	0.62	45.60-50.40	29	173	166	159	129	LFS-40-48
1.90	1.30	0.90	45.60-50.40	29	231	219	210	166	LFS-41-48
2.80	2.60	2.10	45.60-50.40	29	291	279	267	191	LFS-42-48
5.00	4.00	3.00	45.60-50.40	29	348	332	317	255	LFS-43-48
6.50	5.00	3.80	45.60-50.40	29	447	426	409	333	LFS-44-48
10.00	7.50	5.00	45.60-50.40	29	595	568	544	440	LFS-45-48
10.00	7.50	5.00	45.60-50.40	29	595	568	544	440	LFS-45A-48
13.50	12.50	10.50	45.60-50.40	29	719	686	658	505	LFS-46-48
17.00	16.00	14.50	45.60-50.40	29	845	804	773	629	LFS-47-48
22.50	20.50	17.50	45.60-50.40	29	992	946	906	763	LFS-48-48
37.00	34.00	31.00	45.60-50.40	29	1352	1289	1237	1010	LFS-49-48
48.00	45.00	42.00	45.60-50.40	29	1613	1537	1474	1234	LFS-50-48

Part I – AC-to-DC Power Supplies

LF SERIES MECHANICAL DRAWINGS

LFS-38
LFS-39
LFS-40
LFS-41

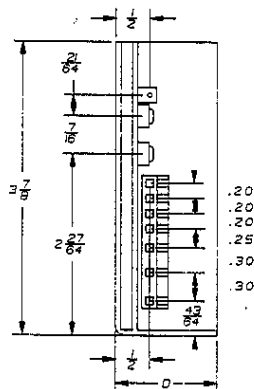
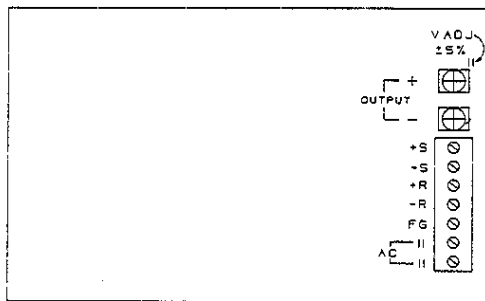

MODEL	NET (LBS.)	SHIPPING LBS.
LFS-38	0.58	1.58
LFS-39	0.74	1.74
LFS-40	1.03	2.03
LFS-41	1.25	2.25

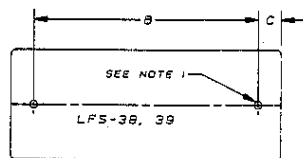

- NOTES:
- NO. 6-32 UNC-2B AND TAPPED HOLES (2) FOR CUSTOMER CHASSIS MOUNTING. (SCREWS MUST NOT PROTRUDE INTO POWER SUPPLY BY MORE THAN 6MM.)
 - NO. 6-32 (LFS-40) AND NO. 8-32 (LFS-41) UNC-20 TAPPED HOLES (3) FOR CUSTOMER CHASSIS MOUNTING (SCREWS MUST NOT PROTRUDE INTO POWER SUPPLY BY MORE THAN 6MM.)

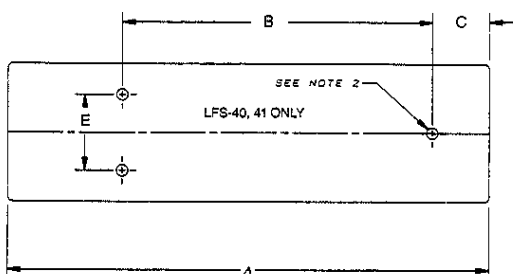

MODEL	A	B	C	D	E
LFS-38	3 ⁹ / ₁₆	2 ²⁹ / ₃₂	5 ¹ / ₁₆	1 ⁷ / ₁₆	—
LFS-39	4 ⁹ / ₁₆	3 ¹⁷ / ₆₄	5 ⁵ / ₁₆	1 ⁷ / ₁₆	—
LFS-40	6 ¹ / ₁₆	5	3 ³ / ₆₄	1 ¹ / ₂	2 ⁵ / ₃₂
LFS-41	6 ¹¹ / ₃₂	3 ¹⁹ / ₁₆	1 ⁹ / ₃₂	1 ¹³ / ₁₆	6 ³ / ₆₄

LFS-42
LFS-43

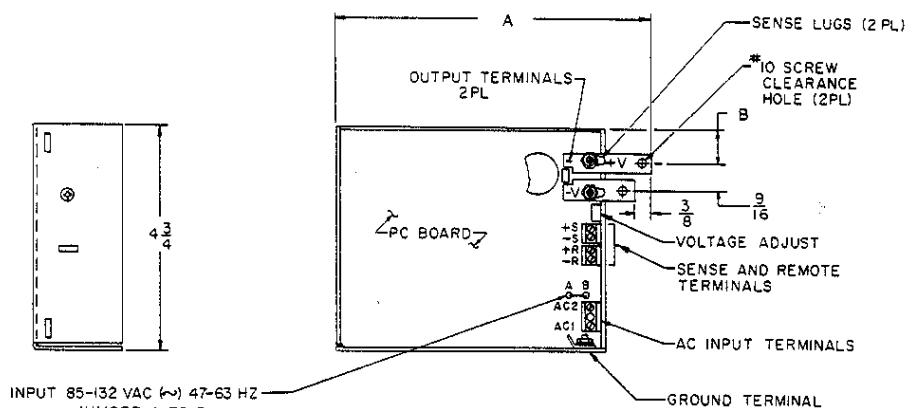

INPUT 85-132 VAC (~) 47-63 HZ
JUMPER A TO B
OR
170-250 VAC (~) OR 250-350 VDC (—)
REMOVE JUMPER A TO B

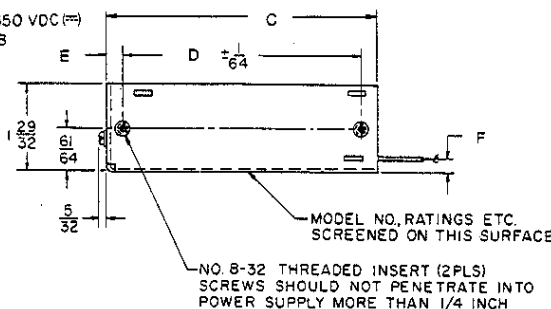

MODEL	NET (LBS.)	SHIPPING LBS.
LFS-42	1.3	2.3
LFS-43	3.0	4.0

	LFS-42	LFS-43
A	6 ²³ / ₃₂	10 ⁹ / ₁₆
B	4 ⁷ / ₆₄	1 ³ / ₃₂
C	5 ¹¹ / ₁₆	9 ¹ / ₈
D	5	6
E	1 ¹ / ₃₂	1 ²⁹ / ₃₂
F	2 ³ / ₆₄	2 ⁵ / ₆₄

LF SERIES MECHANICAL DRAWINGS

LFS-44
LFS-45

	LFS-44	LFS-45
A	11 3/4	15 1/2
B	12 1/2	16 1/2
C	12 7/8	16 1/4
D	13/32	15/32
E	9/16	1.000
F	13/32	7/16
G	7.500	10.500
H	4.000	5.000
J	1 3/4	4 1/4
K	1"	1 25/32

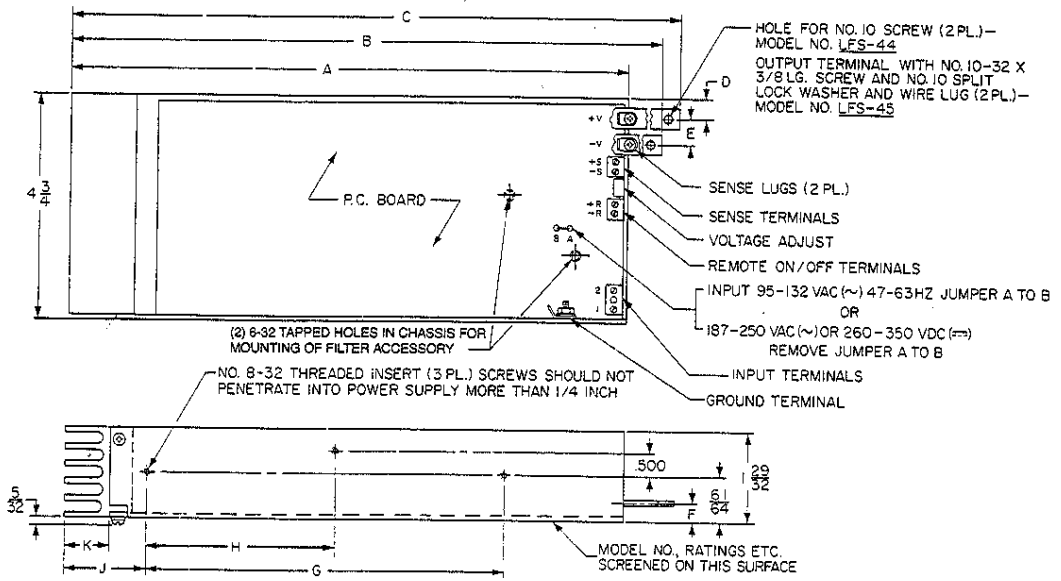

LFS-45A

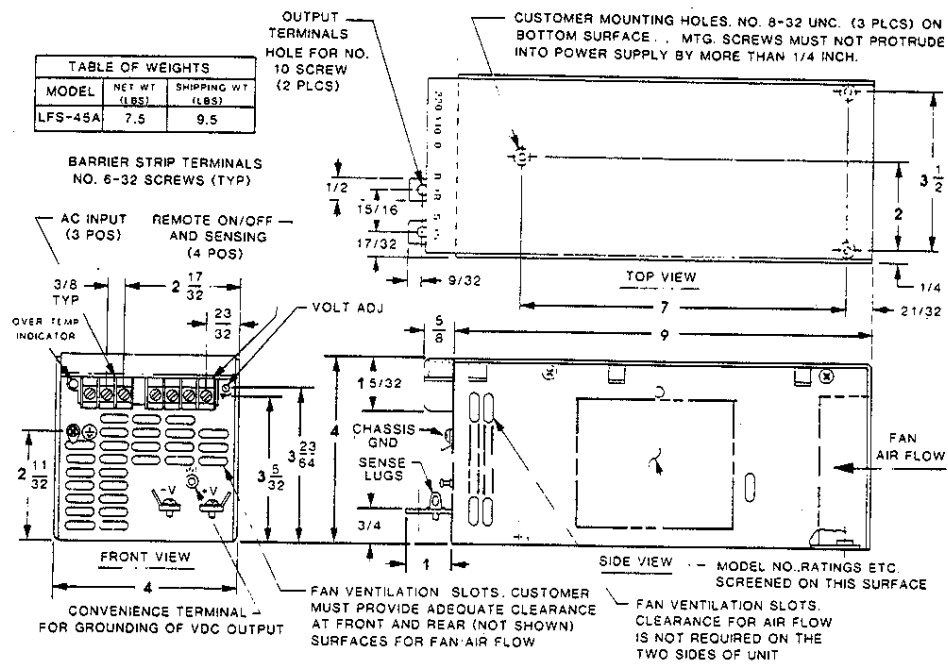

Part I – AC-to-DC Power Supplies

LF SERIES MECHANICAL DRAWINGS

LFS-46
LFS-47
LFS-48

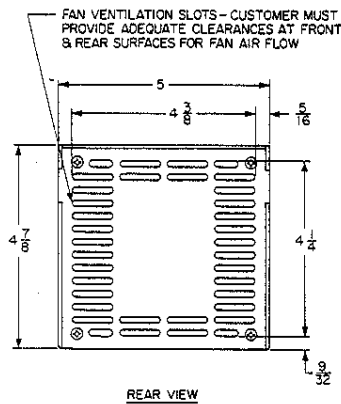
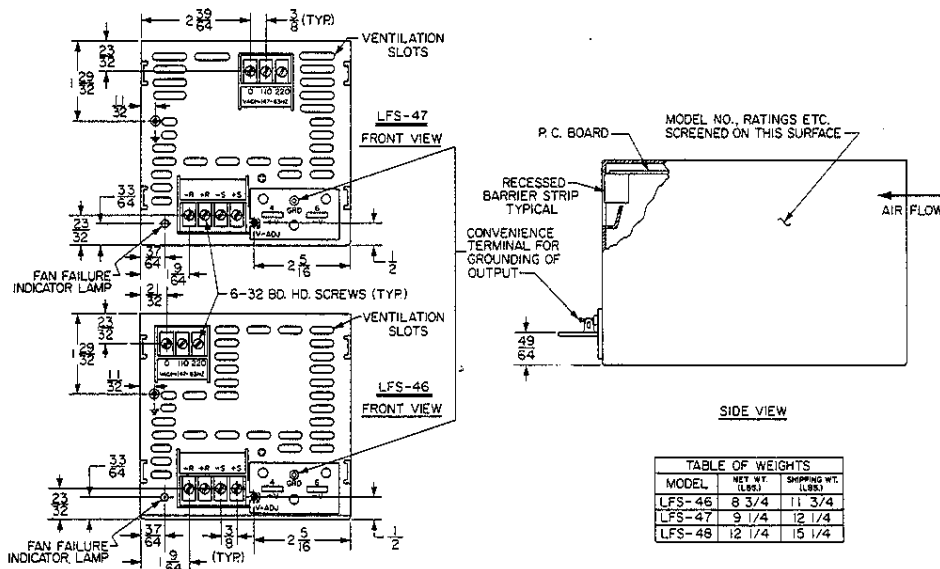
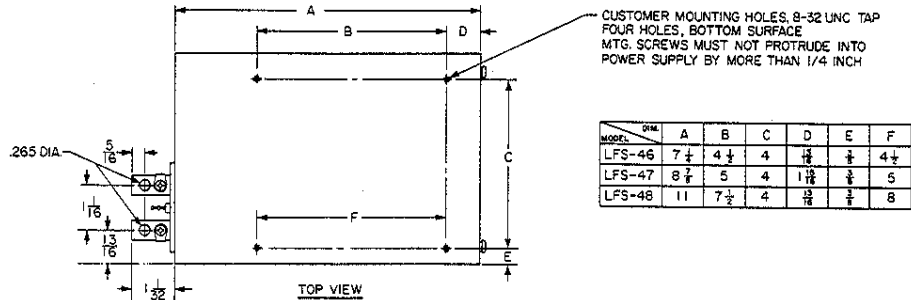

LF SERIES MECHANICAL DRAWINGS

LFS-49
LFS-50

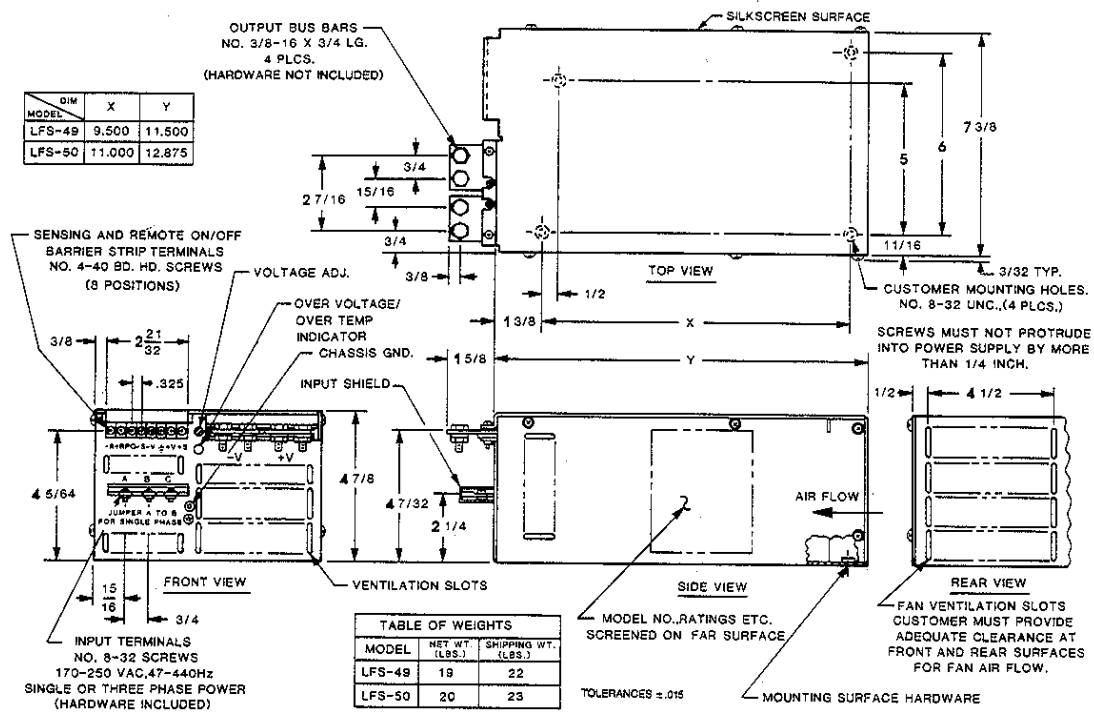

LFS-52

