

AC-DC switch mode power supply

Features

- Wide range input voltage
- MTBF > 400000 hours at 50 °C
- Lifetime 79000 hours at 50 °C
- Operating temperature range - 40 ÷ 85 °C
- Input fuse protection
- Output short circuit protection
- Low stand-by power
- Compliance to: EN60950, EN55014-1, EN55014-2, EN60730-1, EN60730-2-9, EN61010-1, UL60950, CAN/CSA-C22.2 No. 60950-00
- Electrical test on 100% production
- Protected with resin UL conform, RoHS compliant

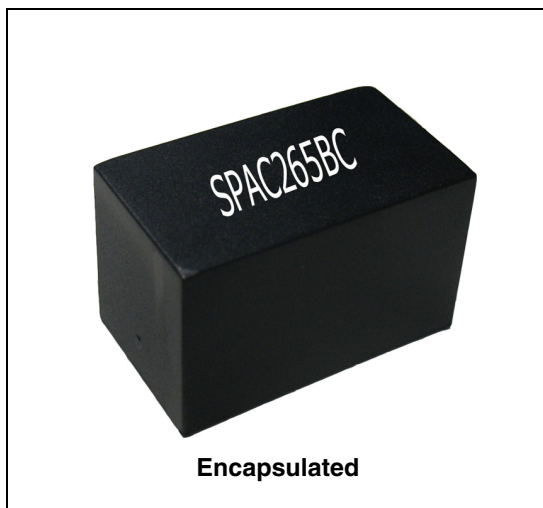

Description

ST's power modules are highly integrated, high efficiency switch mode converters.

The SPAC265-3W isolated series delivers 3 W at 12 V from universal AC input. It is an immediate drop-in solution requiring no additional external circuitry.

The power supply modules are fully encapsulated offline board-mount devices suited for main and auxiliary power requirements in appliance, industrial and communication application.

The open frame version is intended to offer a low-cost version of ST's easy to use, compact size power modules.

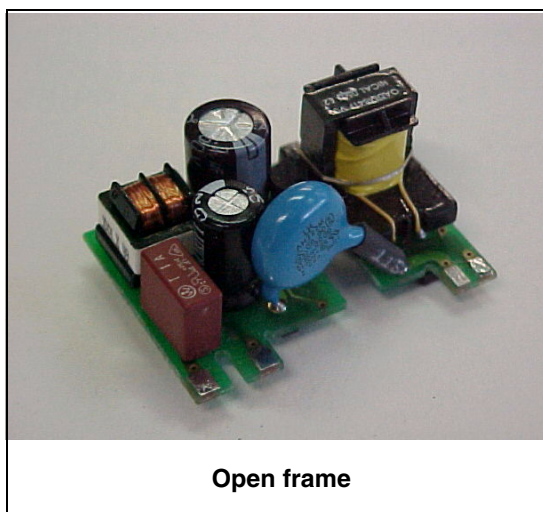

Table 1. Device summary

Order codes	Package
SPAC265BC12P0.30	Encapsulated
SPAC265FC12P0.30	Open frame

Contents

1	Specifications	3
2	Electrical connection	5
3	Connection diagram	6
4	PCB footprint	7
5	Mechanical dimensions	8
6	Ordering information scheme	10
7	Revision history	11

1 Specifications

Table 2. Specifications

Symbol	Parameter	Test condition	Min	Typ	Max	Unit
V _i	Input voltage	Nominal voltage value	90		264	VAC
			120		370	VDC
W _o	Rated power				3	W
f _i	Input frequency range	AC input	47		440	Hz
I _C	Input current - full load	115 VAC			0.4	A
		230 VAC			0.2	
I _{INR}	Inrush current	Pulse < 10 ms			5	A
		115 VAC			10	
		250 VAC				
I _L	Leakage current	50 Hz, 230 VAC			20	μA
V _O	Output voltage			12		V
V _{OA}	Output voltage accuracy	Full load			± 3	%
V _{OLI}	Line voltage regulation	Low to high line			± 1	%
V _{OLO}	Load voltage regulation	5% to 10% full load			± 6	%
I _O	Output current		0		250	mA
f _{SW}	Operating frequency	Self oscillating			300	kHz
E	Efficiency	Full load		80		%
V _{IS}	Isolation voltage	Input to output	3750			VAC
R _{IS}	Isolation resistance	Input to output	100			MΩ
I _{OSH}	Output short-circuit protection	Continuous automatic restart			1	A
T _{OP}	Operating temperature range	Free air convection	-40		85	°C
T _{STG}	Storage temperature range		-40		85	°C
R _H	Relative humidity	Operating conditions			95	%
MTFB	Mean time between failure	According to MIL-HDBK-217E + 50 °C full load	400			Khours
W _E	Weight	Encapsulated			25	g
		Open frame			12	



- Agency approvals
The charger is compliant with most popular safety and EMC requirements, including:
 - EN60950
 - EN55014-1
 - EN55014-2
 - EN60730-1
 - EN60730-2-9
 - EN61010-1
 - UL60950
 - CAN/CSA-C22.2 No. 60950-00

Caution: Module design is performed in accordance with above norms. According to current rules the open frame module can only be certified as part of the customer mother board.

2 Electrical connection

Figure 1. Electrical connection

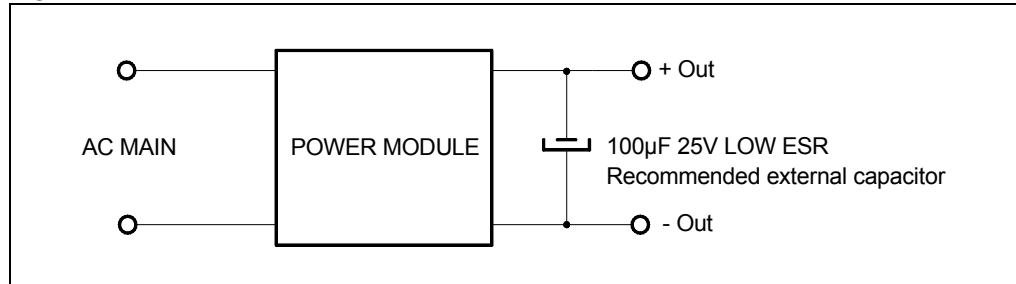

3 Connection diagram

Figure 2. SPAC265-3W pin configuration

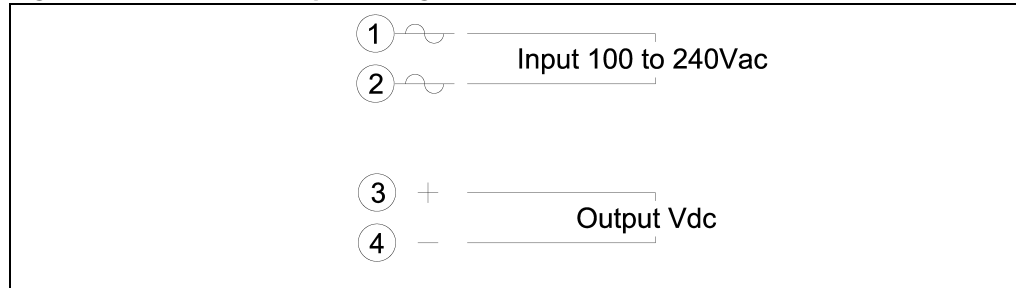

4 PCB footprint

Use [Figure 3](#) as suggested PCB footprint

Figure 3. PCB footprint for SPAC265BC12P0.30 and SPAC265FC12P0.30 (a)

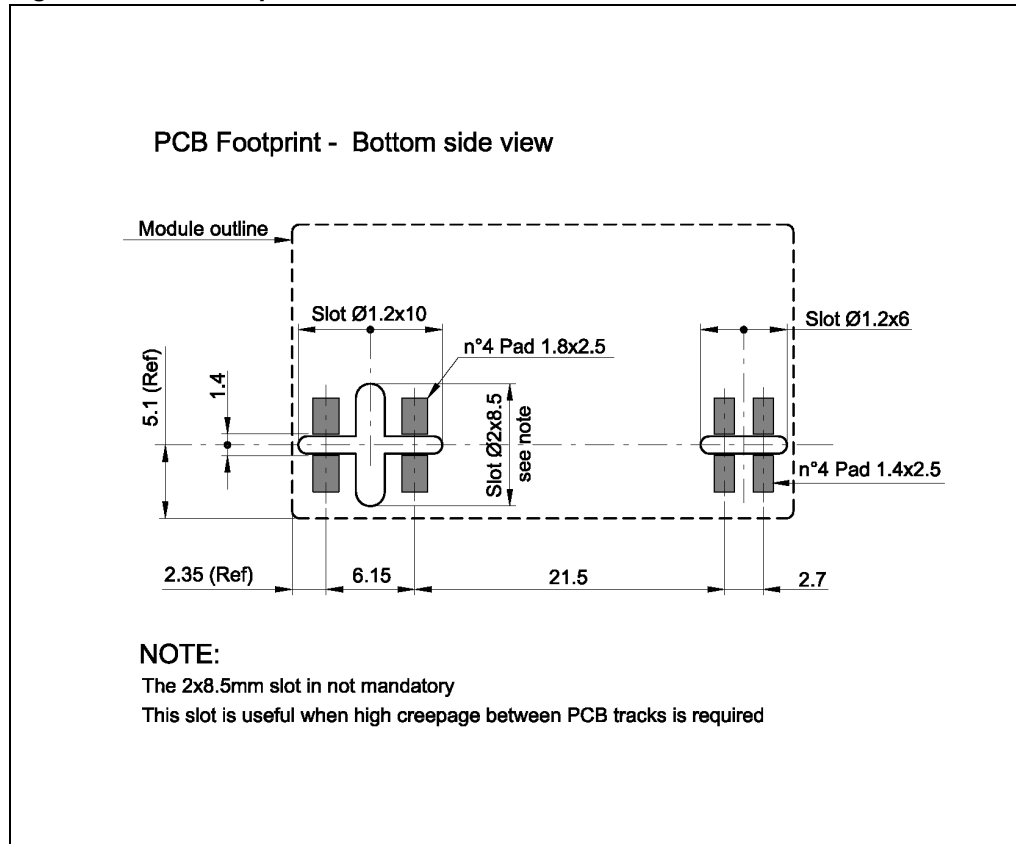

a. Dimensions in mm

5 Mechanical dimensions

In order to meet environmental requirements, ST offers these devices in different grades of ECOPACK® packages, depending on their level of environmental compliance. ECOPACK® specifications, grade definitions and product status are available at: www.st.com. ECOPACK® is an ST trademark.

Mechanical dimensions L x W x H = 35 x 20 x 22 on molded box.

Figure 4. SPAC265BC12P0.30 mechanical data (dimensions in mm)

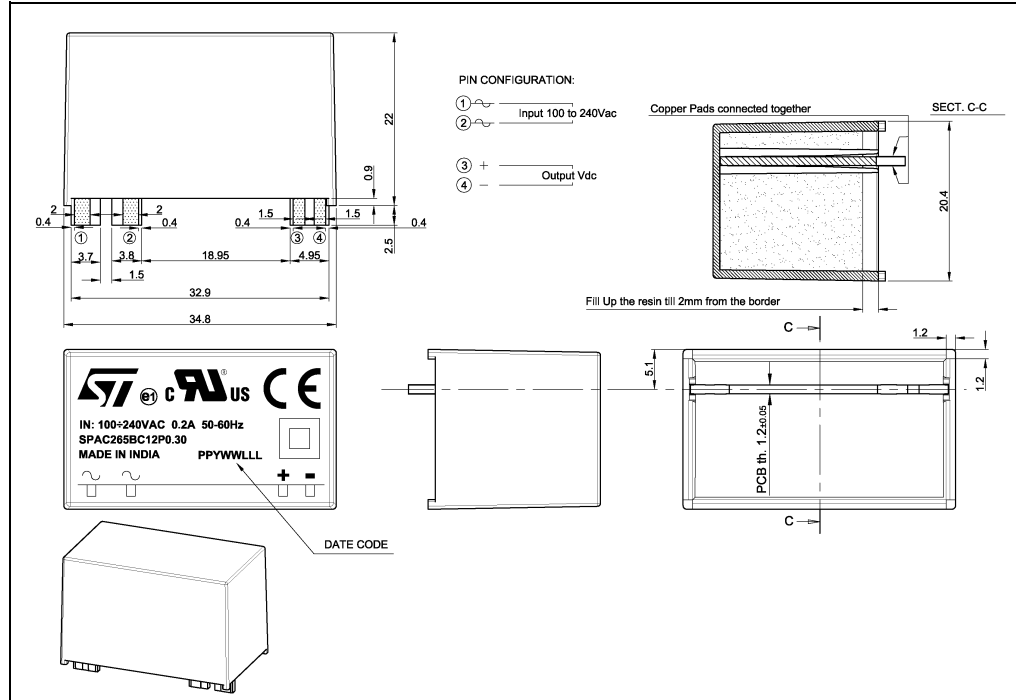
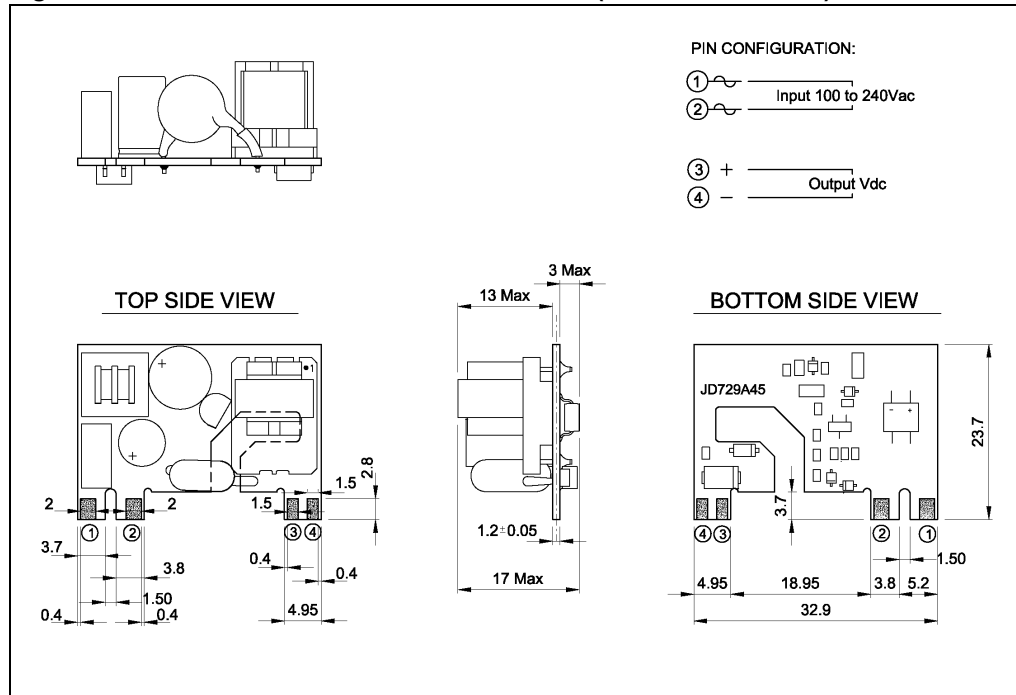

Figure 5. SPAC265FC12P0.30 mechanical data (dimensions in mm)



6 Ordering information scheme

Table 3. Ordering information scheme

	SPAC	265	X	Y	12	Z	0.35
AC-DC converter							
Max V_{AC} input							
F: Open frame B: Encapsulated	Package						
C: Comb	Connection						
Typ VDC output							
P: Plus M: Minus	Output voltage polarity						
Typ IDC output							

7 Revision history

Table 4. Document revision history

Date	Revision	Changes
11-Oct-2007	1	Initial release
17-Dec-2007	2	Updated: operating temperature range in cover page and Table 2 on page 3
17-Nov-2008	3	Updated: Cover page, Table 1 on page 1 , Table 2 on page 3 , Figure 4 on page 8
19-May-2009	4	Added: Figure 3 on page 7

Please Read Carefully:

Information in this document is provided solely in connection with ST products. STMicroelectronics NV and its subsidiaries ("ST") reserve the right to make changes, corrections, modifications or improvements, to this document, and the products and services described herein at any time, without notice.

All ST products are sold pursuant to ST's terms and conditions of sale.

Purchasers are solely responsible for the choice, selection and use of the ST products and services described herein, and ST assumes no liability whatsoever relating to the choice, selection or use of the ST products and services described herein.

No license, express or implied, by estoppel or otherwise, to any intellectual property rights is granted under this document. If any part of this document refers to any third party products or services it shall not be deemed a license grant by ST for the use of such third party products or services, or any intellectual property contained therein or considered as a warranty covering the use in any manner whatsoever of such third party products or services or any intellectual property contained therein.

UNLESS OTHERWISE SET FORTH IN ST'S TERMS AND CONDITIONS OF SALE ST DISCLAIMS ANY EXPRESS OR IMPLIED WARRANTY WITH RESPECT TO THE USE AND/OR SALE OF ST PRODUCTS INCLUDING WITHOUT LIMITATION IMPLIED WARRANTIES OF MERCHANTABILITY, FITNESS FOR A PARTICULAR PURPOSE (AND THEIR EQUIVALENTS UNDER THE LAWS OF ANY JURISDICTION), OR INFRINGEMENT OF ANY PATENT, COPYRIGHT OR OTHER INTELLECTUAL PROPERTY RIGHT.

UNLESS EXPRESSLY APPROVED IN WRITING BY AN AUTHORIZED ST REPRESENTATIVE, ST PRODUCTS ARE NOT RECOMMENDED, AUTHORIZED OR WARRANTED FOR USE IN MILITARY, AIR CRAFT, SPACE, LIFE SAVING, OR LIFE SUSTAINING APPLICATIONS, NOR IN PRODUCTS OR SYSTEMS WHERE FAILURE OR MALFUNCTION MAY RESULT IN PERSONAL INJURY, DEATH, OR SEVERE PROPERTY OR ENVIRONMENTAL DAMAGE. ST PRODUCTS WHICH ARE NOT SPECIFIED AS "AUTOMOTIVE GRADE" MAY ONLY BE USED IN AUTOMOTIVE APPLICATIONS AT USER'S OWN RISK.

Resale of ST products with provisions different from the statements and/or technical features set forth in this document shall immediately void any warranty granted by ST for the ST product or service described herein and shall not create or extend in any manner whatsoever, any liability of ST.

ST and the ST logo are trademarks or registered trademarks of ST in various countries.

Information in this document supersedes and replaces all information previously supplied.

The ST logo is a registered trademark of STMicroelectronics. All other names are the property of their respective owners.

© 2009 STMicroelectronics - All rights reserved

STMicroelectronics group of companies

Australia - Belgium - Brazil - Canada - China - Czech Republic - Finland - France - Germany - Hong Kong - India - Israel - Italy - Japan - Malaysia - Malta - Morocco - Philippines - Singapore - Spain - Sweden - Switzerland - United Kingdom - United States of America

www.st.com