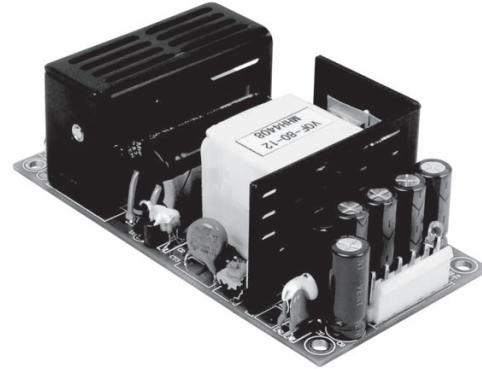

PART NUMBER: VOF-80

DESCRIPTION: switching power supply

features

- no-load power consumption < 0.5W
- universal input 85~264 V ac
- over current, over voltage protected
- industry standard footprint
- efficiency up to 89%
- safety approved to CB, TUV, CE, UL/cUL
- conducted EMI meets EN55022 class B and FCC class B

MODEL

	output voltage (V dc)	output current (A)	total regulation ^{1,2} (%)	ripple & noise ³ (mVp-pmax.)	efficiency (%)
VOF-80-3.3	3.3	8 ~ 10	±5	120	75
VOF-80-5	5	8 ~ 10	±5	120	76
VOF-80-12	12	6.66	±5	120	85
VOF-80-15	15	5.33	±5	150	86
VOF-80-24	24	3.33	±5	240	87
VOF-80-48	48	1.66	±5	480	89

- notes:
1. Measured from high line to low line at rated load.
 2. Measured from full load to 10% load at 110 V ac.
 3. Ripple & noise are measured at 20MHz of bandwidth with a 0.1 µf ceramic cap. & a 10 µf electrolytic cap. on the output. The two earth ground pads are connected to input earth ground.

INPUT

parameter	conditions/description	min	nom	max	units
input frequency		47		63	Hz
input voltage	output power derated from 85-90 V ac	85		264	V ac
input current	AC input of 110 V ac		1500		mA
	AC input of 220 V ac		800		mA
inrush current	AC input of 110 V ac, full load, cold start			25	A
	AC input of 220 V ac, full load, cold start			50	A
input fuse	built-in, non-user serviceable				

OUTPUT

parameter	conditions/description	min	nom	max	units
efficiency	see table above, typical values measured at 115 V ac, full load				
hold up time	at 115 V ac, full load	8			mS
adjustability		-10		+5	%
temp. coefficient		-0.05		+0.05	%/°C

PART NUMBER: VOF-80

DESCRIPTION: switching power supply

PROTECTION CIRCUIT

parameter	conditions/description
output overload	current limiting starts at 105% of the rated output current and recovers automatically
output over voltage	output voltage is limited by TVS clamping to: 6.8 V for 3.3 & 5 V models, 135% for all other models
output short circuit	protected, long-term short circuit may reduce reliability

GENERAL AND SAFETY

parameter	conditions/description	min	nom	max	units
switching frequency			65		kHz
operating temp.		0		60	°C
storage temp.		-20		85	°C
operating humidity	non-condensing	20		90	% RH
storage humidity	non-condensing	20		95	% RH
operating altitude			10000 / 3000		ft / m
storage altitude			30000 / 9000		ft / m
leakage current	per EN60950, 264 V ac			1.5	mA
isolation voltage	primary to secondary	3000			V ac
(for 1 minute)	primary to transformer core	1500			V ac
	primary to ground	1500			V ac
RoHS	yes				
safety	approved to CB, TUV EN60950, CE, UL/cUL 60950-1				
EMI	conducted emission comply with FCC class B, EN55022 class B				
insulation resistance	measured at 500 V dc, room temperature	50			MΩ

INPUT VOLTAGE VS LOAD

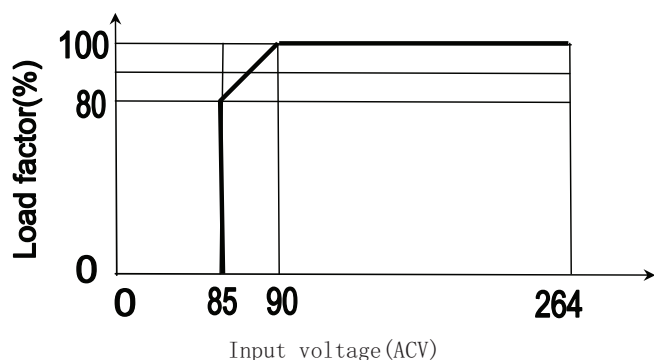

PART NUMBER: VOF-80

DESCRIPTION: switching power supply

TEMPERATURE VS LOAD

*for 3.3, 5 V models

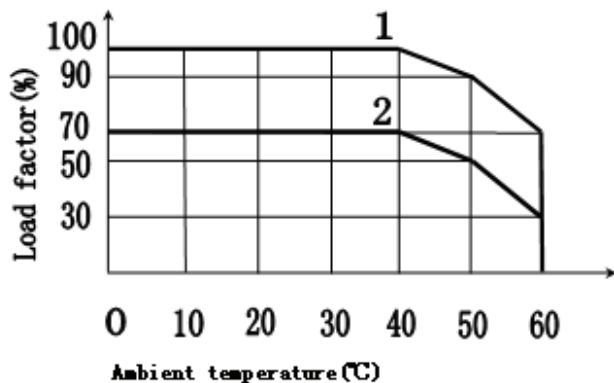

*for 12, 15, 24, 48 V models

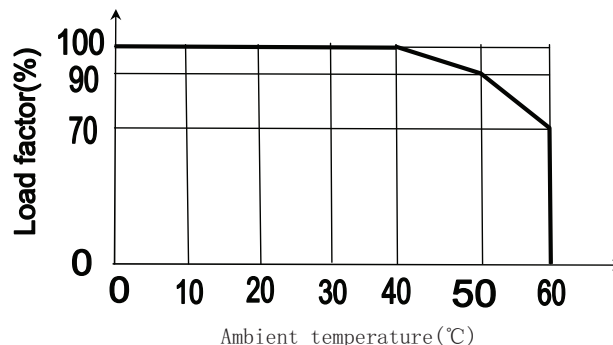

1. forced air with velocity of 1m/s
2. free air convection

MECHANICAL

parameter	conditions/description
dimensions	4" (102 mm) x 2" (51 mm) x 1.28" (32.6 mm)
weight	0.2 Kg
cooling method	free air convection or forced air (see derating curves below)

MATING CONNECTORS

parameter	conditions/description
ac input (CN1)	mates with Molex housing 09-50-3031 with Molex 2878 series crimp contact
dc output (CN2)	mates with Molex housing 09-50-3061 with Molex 2878 series crimp contact

MOUNTING METHOD

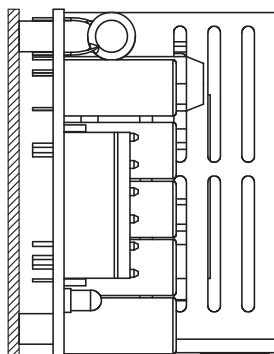

A. Vertical

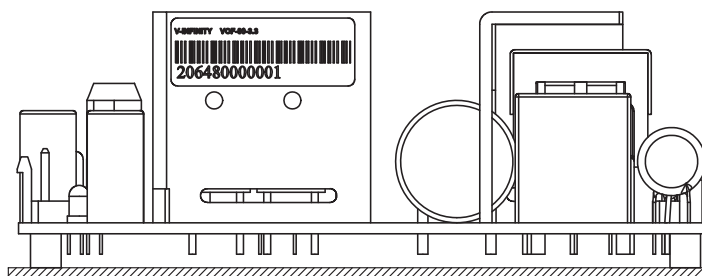

B. Horizontal

REV.	DESCRIPTION	DATE
A	NEW DRAWING	9/15/2009

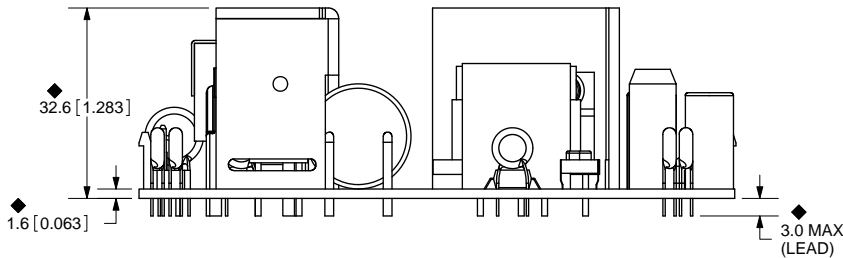
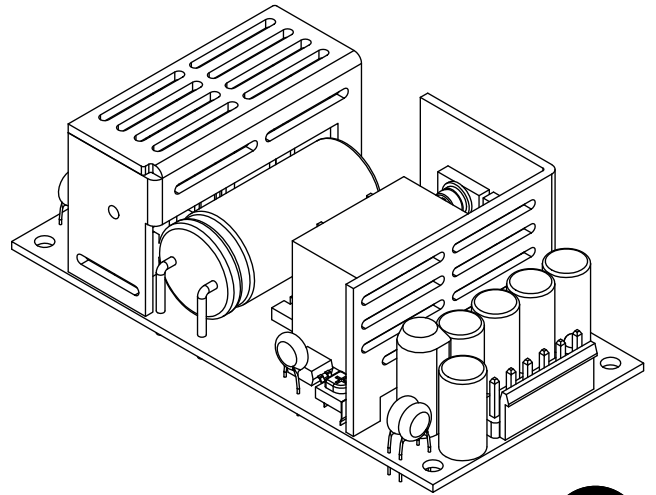
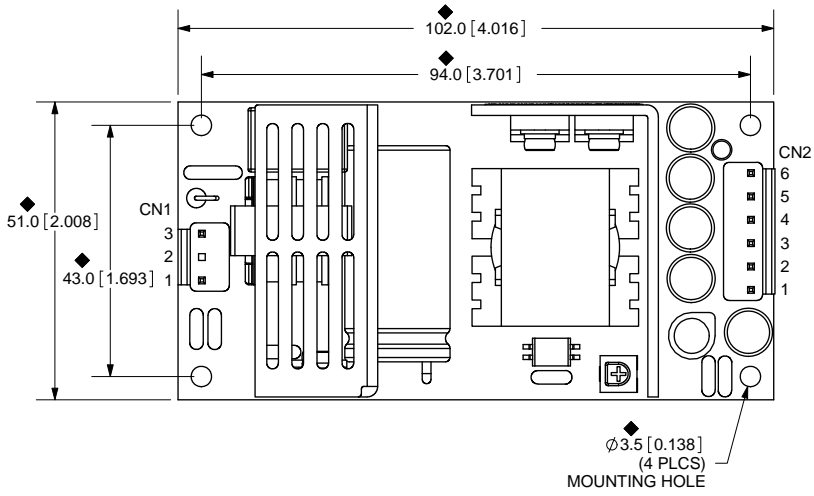

◆ NOTES:
CRITICAL DIMENSIONS
FOR INSPECTION
TOLERANCE: ±1.0mm



20050 SW 112th Ave.
Tualatin, OR 97062
Phone: 503-612-2300
800-275-4899
Fax: 503-612-2383
Website: www.cui.com

CN1		
1	2	3
L	no pin	N

TITLE: VOF-80 MECHANICAL DRAWING REV: A

PART NO. VOF-80-mech UNITS: MM [INCHES]

DRAWN BY: ZRJ APPROVED BY: SCALE: 1:1

CN2					
1	2	3	4	5	6
-V	-V	-V	+V	+V	+V

PC FILE NAME:
VOF-80-mech

COPYRIGHT 2009 BY CUI INC.