

PART NUMBER: VOF-45

DESCRIPTION: switching power supply

features

- RoHS compliant
- universal input 85~264 Vac
- output over-current protected
- output over-voltage protected
- industry standard foot-print
- efficiency up to 88%
- safety approved to TUV, CE; UL/cUL
- conducted EMI meets EN55022 class B and FCC class B

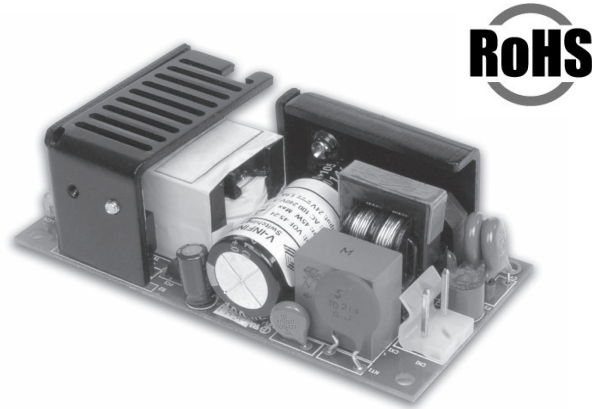

model	voltage (Vdc)	current (A)	total 1, 2 regulation	ripple & noise ³ (mVp-p max)	efficiency
VOF-45-3.3	3.3	6.0	±5%	50	74%
VOF-45-5	5	6.0	±5%	50	78%
VOF-45-7.5	7.5	5.0	±5%	75	78%
VOF-45-9	9	4.4	±5%	90	82%
VOF-45-12	12	3.7	±5%	120	84%
VOF-45-15	15	3.0	±5%	150	85%
VOF-45-24	24	1.9	±5%	240	86%
VOF-45-48	48	0.93	±5%	480	88%

notes:

1. measured from high line to low line at full load.
2. measured from full load to 10% load at 110 VAC.
3. ripple & noise measured at 20 MHz BW, with a 0.1 μ F ceramic cap and a 10 μ F electrolytic cap on the output and the two earth ground pads are connected to input earth ground.

PART NUMBER: VOF-45

DESCRIPTION: switching power supply

INPUT

parameter	conditions/description	min	nom	max	units
input frequency		47		63	Hz
input voltage	output power derated from 85-90 VAC	85		264	VAC
input current	AC input of 110 VAC		1000		mA
	AC input of 210 VAC		500		mA
inrush current	measured at 110 VAC at full load, cold start			25	A
	measured at 220 VAC at full load, cold start			50	A
input fuse	built-in, non-user serviceable.				

OUTPUT

parameter	conditions/description	min	nom	max	units
efficiency	see table above. typical values measured at 115 VAC, full load.				
hold up time	at 115 VAC, full load	8			mS
adjustability	adjustable with built-in trim pot.	- 5		+5	%
temp. coefficient		-0.05		+0.05	%/°C

PROTECTION CIRCUIT

parameter	conditions/description
overload	current limiting starts at 105% of the rated output current and recovers automatically.
output over-voltage	output voltage is limited to 115% by TVS clamping.
short circuit	protected. long term short circuit may reduce reliability.

GENERAL AND SAFETY

parameter	conditions/description	min	nom	max	units
switching frequency			60		KHz
operating temp.	see derating curves.	0		50	°C
storage temp.		-20		85	°C
operating humid.	non-condensing	20%		90%	RH
storage humid.	non-condensing	20%		95%	RH
operating altitude				3,000	m
				10,000	ft
storage altitude				9,000	m
				30,000	ft
EMI	conducted emissions comply with FCC class B, EN55022 class B				
safety	approved to TUV EN60950, CE, CB; UL/cUL 60950-1				
RoHS	2002/95/EC				
leakage current	per EN60950, 264 VAC			1.5	mA
isolation voltage	applied for 1 minute.				
(HI-POT)	primary to secondary:	3000			VAC
	primary to transformer core:	1500			VAC
	primary to earth ground:	1500			VAC
insulation resistance	measured at 500 VDC, at room temp.	50			MΩ
MTBF (@ 25°C)	MIL-HDBK-217F	250K			hours
warranty	standard warranty length			2	years

PART NUMBER: VOF-45

DESCRIPTION: switching power supply

MECHANICAL

parameter	conditions/description	min	nom	max	units
dimensions	4"(102mm) x 2"(51mm) x 1.26"(32mm)				
weight				0.17	kg
cooling method	free air convection (see derating curves below)				

MATING CONNECTORS

parameter	conditions/description
AC input (CN1)	mates with Molex housing 09-50-3031 with Molex 2878 series crimp contact.
DC output (CN2)	mates with Molex housing 09-50-3041 with Molex 2878 series crimp contact.

DERATING CURVES

1. output power vs. ambient temperature

a. 3.3, 5, 7.5 V models

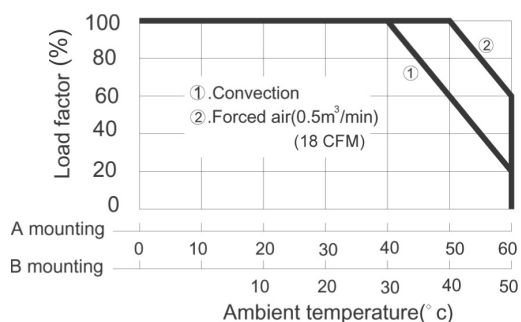

b. all other models

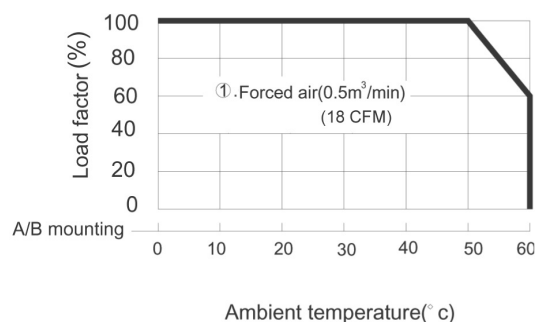

2. output power vs. input voltage

all models

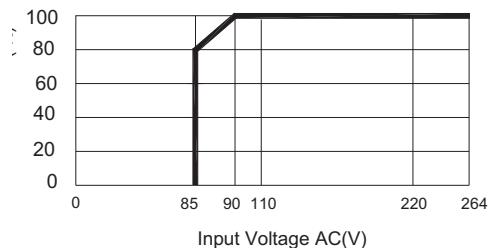

REV.	DESCRIPTION	DATE
A	NEW DRAWING	10/23/2006

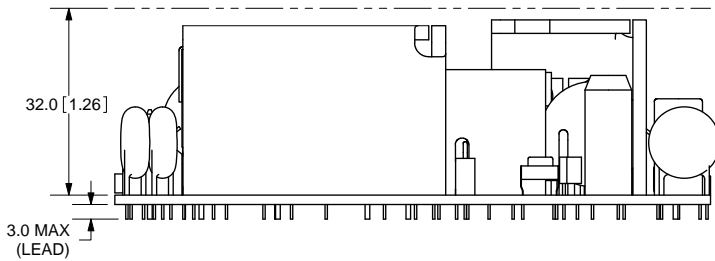
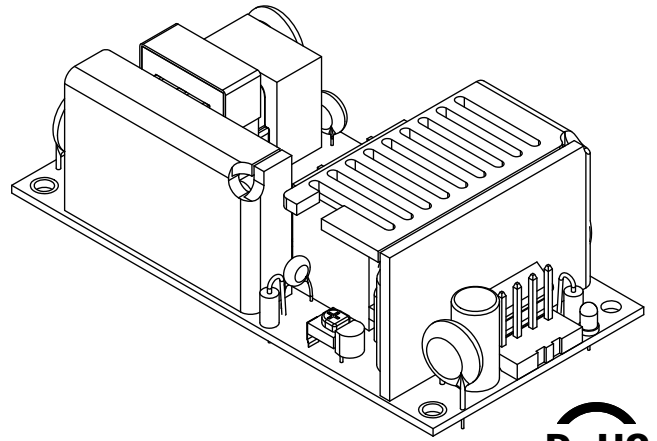
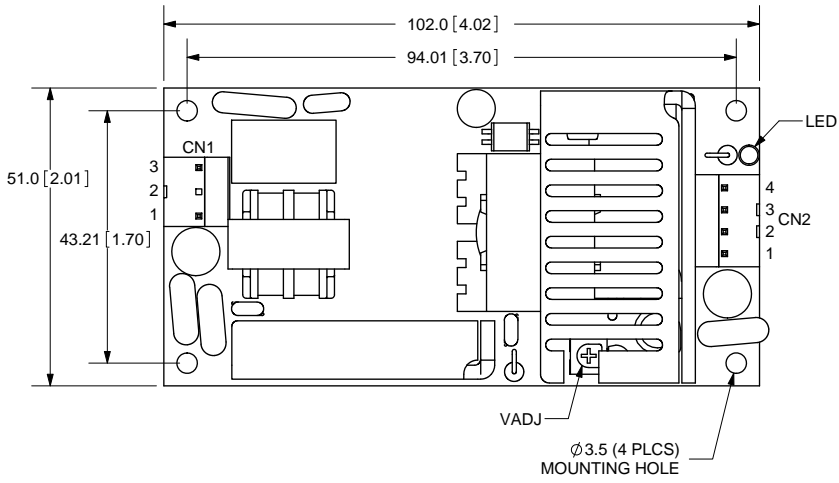

20050 SW 112th Ave.
Tualatin, OR 97062
Phone: 503-612-2332
866-372-1258
Fax: 503-612-2382
Website: www.v-infinity.com

CN1		
1	2	3
L	no pin	N

TITLE: SWITCHING POWER SUPPLY	REV: A
-------------------------------	--------

CN2			
1	2	3	4
-V	-V	+V	+V

PART NO. VOF-45	UNITS: MM [INCHES]
-----------------	--------------------

DRAWN BY: ZRJ	APPROVED BY:	SCALE: 1:1
---------------	--------------	------------

PC FILE NAME:
VOF-45

COPYRIGHT 2010 BY CUI INC.

REV.	DESCRIPTION	DATE
-	See Sheet1	-

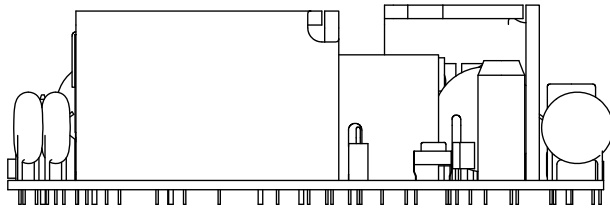

B. Horizontal

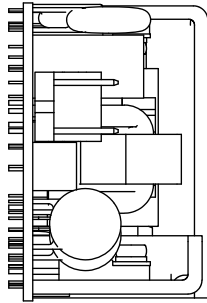

A. Vertical



V-INFINITY

20050 SW 112th Ave.
Tualatin, OR 97062
Phone: 503-612-2332
866-372-1258
Fax: 503-612-2382
Website: www.v-infinity.com

TITLE: SWITCHING POWER SUPPLY		REV: A
PART NO: VOF-45	UNITS: MM [INCHES]	
DRAWN BY: ZRJ	APPROVED BY:	SCALE: 1:1

PC FILE NAME:
VOF-45

COPYRIGHT 2006 BY CUI INC.