

AV60C Half-brick Size Series

Technical Reference Notes

48V Input, 5V and 3.3V Single Output

30W DC-DC Converter

(Rev01)



Introduction

The AV60C-30W series of switching DC-DC converters is one of the most cost effective options available in component power. The AV60C-30W series uses an industry standard package size of **2.4"x2.28"x0.5"** and pinout configuration, provides standard control, trim, and sense functions, also features high power density up to **10.96W/in³** which gives more selectivity to meet small size requirement.

AV60C-30W series comes in 48V input version with a 2:1 (36-75V) input range. This series has input LVP, output OVP, OCP, and short circuit protection. There are isolated single output 3.3V, 5V and the isolation voltage is 1500Vdc. This series is designed to meet CISPR22, FCC class A, UL and CSA certifications.

The design features of the AV60C-30W series set a new standard for high density power converters. The unit employs a conventional multi-layer printed circuit board to carry all of the power components on the bottom layer, all of the small signal control circuit on top layer, all constructed with automated SMD technology. The module is sealed with Silastic.

Design Feature

- ☞ High Efficiency
- ☞ High power density
- ☞ Low output noise
- ☞ CNT function
- ☞ Remote sense
- ☞ Trim function
- ☞ Input under-voltage lockout
- ☞ Output short circuit protection
- ☞ Output current limiting
- ☞ Output over-voltage protection (clamp)
- ☞ High input-output isolation voltage

Options

- ☞ Heat sink available for extended operation.
- ☞ Choice of CNT logic configuration.

Typical Application

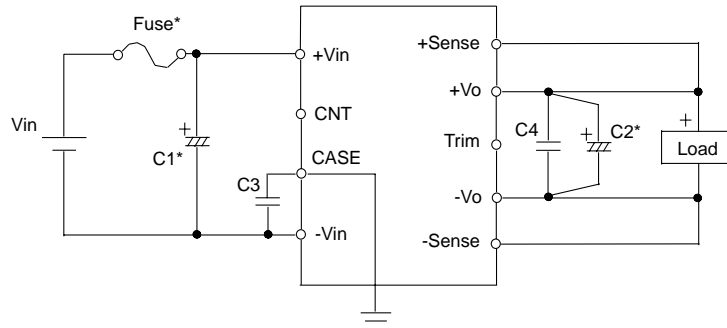

Fuse*: Use external fuse (fast blow type) for each unit.

AV60C-30W Series : 5A fuse

C1*: Recommended input capacitor C1

-20 °C ~ +100 °C : $\geq 47\mu\text{F}/100\text{V}$ electrolytic or ceramic type capacitor.

-40 °C ~ +100 °C : $\geq 47\mu\text{F}/100\text{V}$ ceramic type capacitor only.

C2*: Recommended output capacitor C2

-20 °C ~ +100 °C : $1000\mu\text{F}/25\text{V}$ (electrolytic capacitor)

-40 °C ~ +100 °C : For this temperature range, use two pieces of the recommended capacitor above.

C3: Recommended $0.01\mu\text{F}/2000\text{V}$

C4: Recommended $1\mu\text{F}/10\text{V}$

EMI Reduction Filter

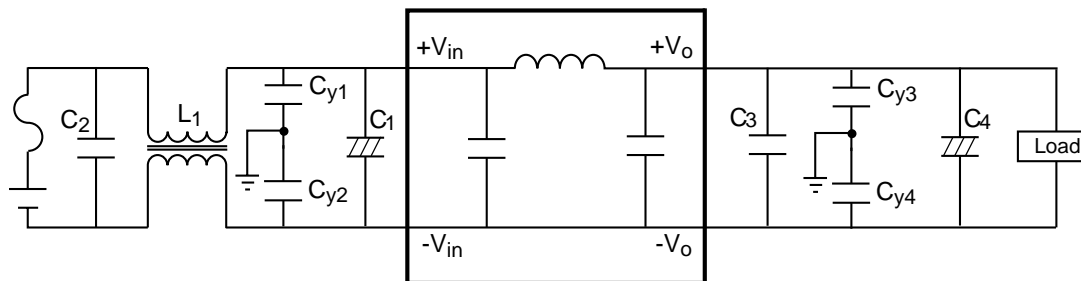

For conditions where EMI is a concern, a different input filter can be used. It shows the input filter and the output filter designed to reduce EMI effects. C1 is a $47\mu\text{F}/100\text{V}$ electrolytic capacitor, and C2,C3 are $1\mu\text{F}/100\text{V}$ metal film or ceramic high frequency capacitor, C4 is a $1000\mu\text{F}/25\text{V}$ electrolytic capacitor, Cy1 and Cy2 are each $2200\text{pF}/1500\text{Vdc}$ high frequency ceramic capacitors, Cy3 and Cy4 are each $4700\text{pF}/1500\text{Vdc}$ high frequency ceramic capacitors, and L1 is a 4mH common mode choke.

When a filter inductor is connected in series with the power converter input, an input capacitor C1 should be added. An input capacitor C1 should also be used when the input wiring is long, since the wiring can act as an inductor. Failure to use an input capacitor under these conditions can produce large input voltage spikes and an unstable output.

**AV60C Half-Brick Size DC-DC Converters
36VDC to 75VDC Input, 30W Output**

Block Diagram

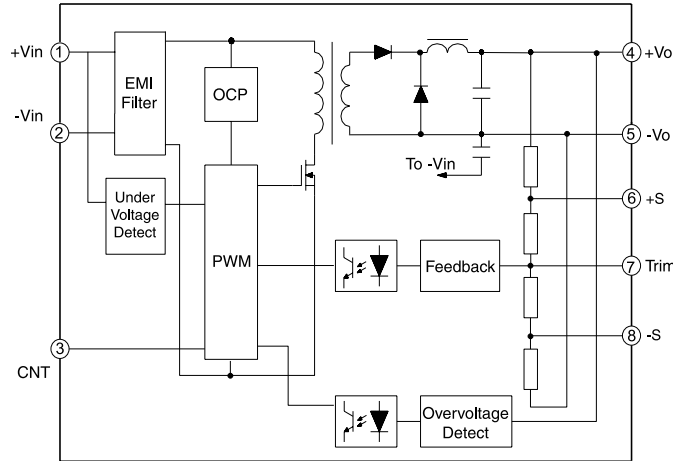

Ordering Information

Model Number	Input Voltage	Output Voltage	Output Current	Ripple (mV rms)	Noise (mV pp)	Efficiency	
						min	typ
AV60C-048L-033F06(-8)	36-75V	3.3V	6.5A	20	150	81%	84%
AV60C-048L-050F06(-8)	36-75V	5V	6.0A	20	150	84%	87%

USA

TEL: 1-760-930-4600

FAX: 1-760-930-0698

Europe

44-(0)1384-842-211

44-(0)1384-843-355

Asia

852-2437-9662

852-2402-4426

www.astec.com



AV60C Half-Brick Size DC-DC Converters
36VDC to 75VDC Input, 30W Output

Absolute Maximum Rating

Characteristic	Min	Typ	Max	Units	Notes
Input Voltage(continuous)	-		80	Vdc	
Operating case temperature	-40		100	°C	Referring to the derating curves on page 22
Working ambient temperature	-40		50	°C	
storage temperature	-55		125	°C	

Input Characteristics

Characteristic	Min	Typ	Max	Units	Notes
Input Voltage Range	36	48	75	Vdc	
Input Reflected Current		25	50	mAp-p	
Turn-off Input Voltage	30	--	35	V	
Turn-on Input Voltage	31	--	36	V	
Turn On Time		80	150	ms	

Control Function

Characteristic	Min	Typ	Max	Units	Notes
Logic High			6	Vdc	Reverse logic available
Logic Low	-0.7		1.2	Vdc	
Control Current			1.0	mA	

General Specifications

Characteristic	Min	Typ	Max	Units	Notes
MTBF		1750		k Hrs	Bellcore TR332, Tc=40°C
Isolation			1500	Vdc	
Pin solder temperature			260	°C	wave solder < 10 s
Hand Soldering Time			5	s	iron temperature 425°C
Weight			150	grams	

USA

TEL: 1-760-930-4600

FAX: 1-760-930-0698

Europe

44-(0)1384-842-211

44-(0)1384-843-355

Asia

852-2437-9662

852-2402-4426

www.astec.com



**AV60C Half-Brick Size DC-DC Converters
36VDC to 75VDC Input, 30W Output**

AV60C-048L-033F06(-8) Output Characteristics

Characteristic	Min	Typ	Max	Units	Notes
Power		21.5		W	
Output Current	0.6		6.5	A	
Output Setpoint Voltage	3.25	3.3	3.35	Vdc	Vin=48V, Io=6.5A
Line Regulation		0.1	0.2	%Vo	Vin=36~75V, Io=6.5A
Load Regulation		0.2	0.5	%Vo	Io=0~6.0A, Vin=48V
Dynamic Response					
50-75% load(peak deviation)		2	5	%Vo	Ta=25°C, DI/Dt=1A/10µs
setting time		300	500	µs	Ta=25°C, DI/Dt=1A/10µs
50-25% load(peak deviation)		2	5	%Vo	Ta=25°C, DI/Dt=1A/10µs
setting time		300	500	µs	Ta=25°C, DI/Dt=1A/10µs
Current Limit Threshold	7.2		10	A	
Output Short Circuit Current		11.2		A	
Efficiency	81	84		%	Vin=48V, Io=6.5A
Trim Range	80		110	%Vo	
Over Voltage Protection Setpoint	4		5.7	V	
Sense Compensation			10	%Vo	5%Vo each leg
Temperature Regulation	-0.03		0.03	%Vo/°C	
Ripple (rms)			20	mV	(0 to 20MHz Bandwidth)
Noise (p-p)			150	mV	(0 to 20MHz Bandwidth)
Switching Frequency		370		kHz	
Maximum Capacitor Load			10,000	µF	

USA

TEL: 1-760-930-4600

FAX: 1-760-930-0698

Europe

44-(0)1384-842-211

44-(0)1384-843-355

Asia

852-2437-9662

852-2402-4426

www.astec.com



AV60C Half-Brick Size DC-DC Converters
36VDC to 75VDC Input, 30W Output

AV60C-048L-050F06(-8) Output Characteristics

Characteristic	Min	Typ	Max	Units	Notes
Power		30		W	
Output Current	0.6		6.0	A	
Output Setpoint Voltage	4.95	5.0	5.05	Vdc	Vin=48V, Io=6.0A
Line Regulation		0.1	0.2	%Vo	Vin=36~75V, Io=6.0A
Load Regulation		0.2	0.5	%Vo	Io=0~6.0A, Vin=48V
Dynamic Response					
50-75% load(peak deviation)		2	5	%Vo	Ta=25°C, DI/Dt=1A/10µs
setting time		300	500	µs	Ta=25°C, DI/Dt=1A/10µs
50-25% load(peak deviation)		2	5	%Vo	Ta=25°C, DI/Dt=1A/10µs
setting time		300	500	µs	Ta=25°C, DI/Dt=1A/10µs
Current Limit Threshold	6.6		9	A	
Output Short Circuit Current		10.5		A	
Efficiency	84	87		%	Vin=48V, Io=6.0A
Trim Range	80		110	%Vo	
Over Voltage Protection Setpoint	5.6		7.0	V	
Sense Compensation			0.5	V	0.25V each leg
Temperature Regulation	-0.03		0.03	%Vo/°C	
Ripple (rms)			20	mV	(0 to 20MHz Bandwidth)
Noise (p-p)			150	mV	(0 to 20MHz Bandwidth)
Switching Frequency		370		kHz	
Maximum Capacitor Load			10,000	µF	

USA

TEL: 1-760-930-4600

FAX: 1-760-930-0698

Europe

44-(0)1384-842-211

44-(0)1384-843-355

Asia

852-2437-9662

852-2402-4426

www.astec.com



Efficiency Characteristic Curves (at 25 °C)

Typical Efficiency AV60C-048L-033F06(-8)

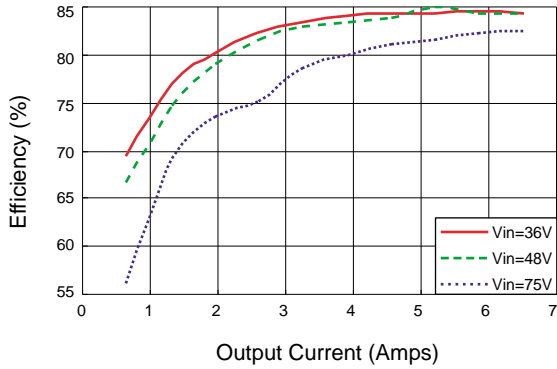

Typical Efficiency AV60C-048L-050F06(-8)

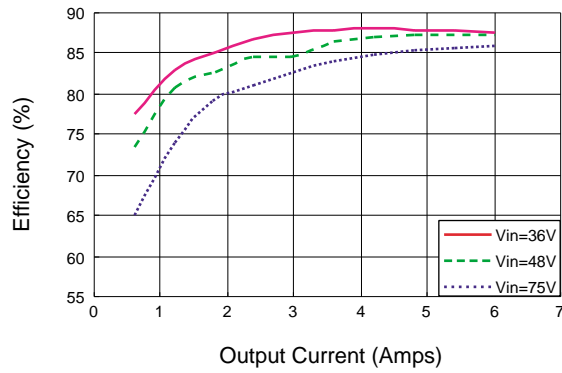

Overcurrent Protection (OCP)(at 25 °C)

Typical Output Overcurrent Performance
AV60C-048L-033F06(-8)

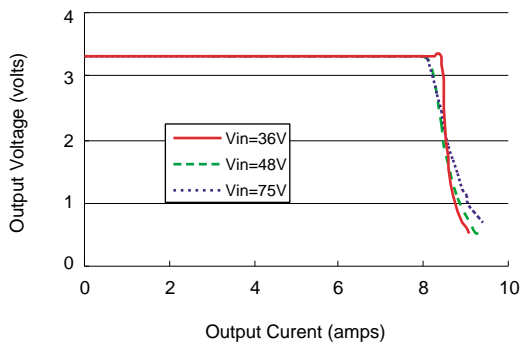

Typical Output Overcurrent Performance
AV60C-048L-050F06(-8)

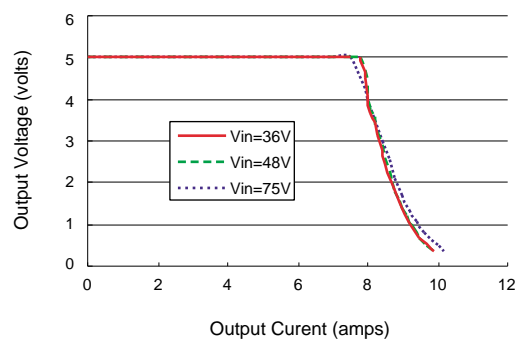

Input Characteristic (at 25 °C)

Typical Input Current AV60C-048L-033F06(-8)

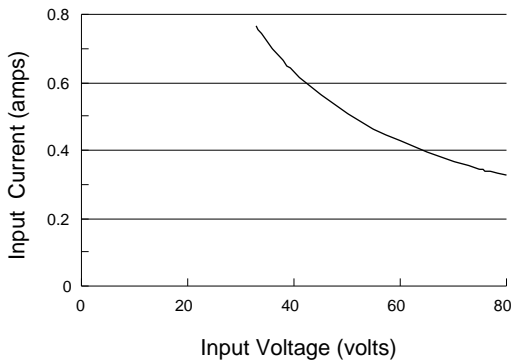

Typical Input Current AV60C-048L-050F06(-8)

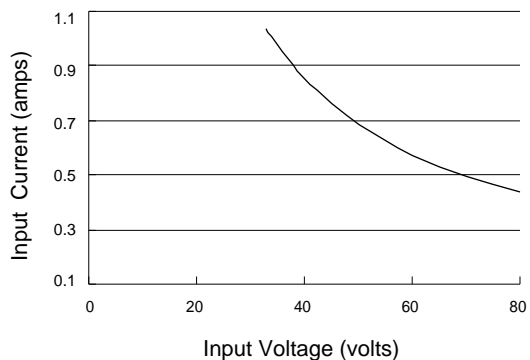

Transient response (at 25 °C)

Typical Transient Response Load Increased
from 25%I_omax to 50%I_omax
AV60C-048L-033F06(-8)

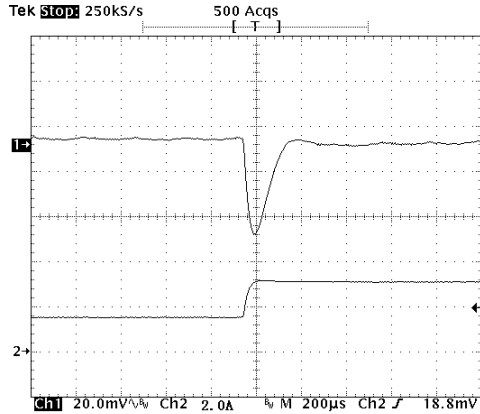

Typical Transient Response Load Decreased
from 25%I_omax to 50%I_omax
AV60C-048L-050F06(-8)

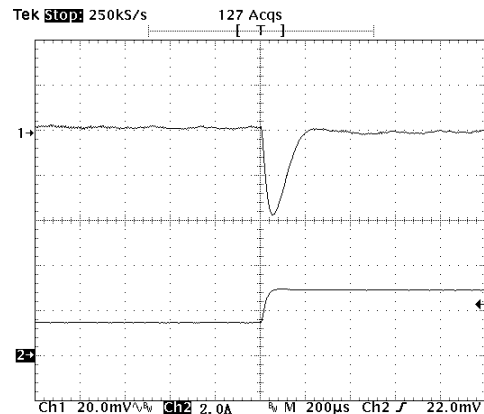

Typical Transient Response Load Increased
from 50%I_omax to 75%I_omax
AV60C-048L-033F06(-8)

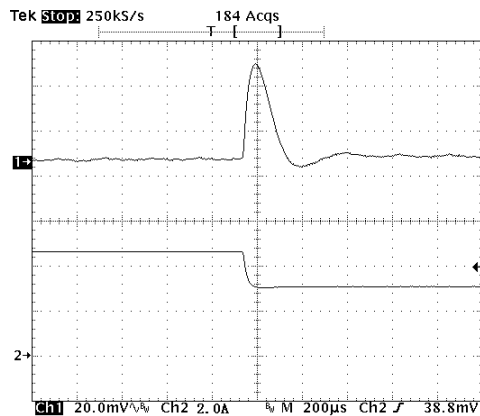

Typical Transient Response Load Increased
from 50%I_omax to 75%I_omax
AV60C-048L-050F06(-8)

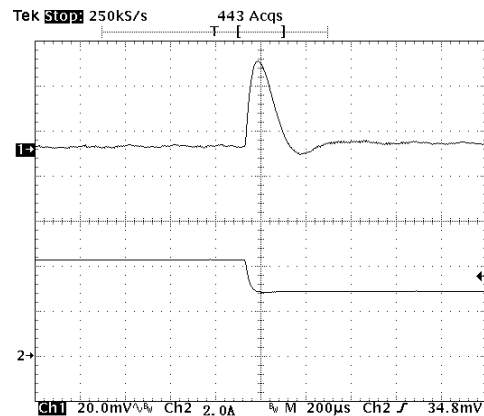

Characteristic Curves *(rated input voltage, full load, at 25 °C)*

Typical Start-Up from Power On
AV60C-048L-033F06(-8)

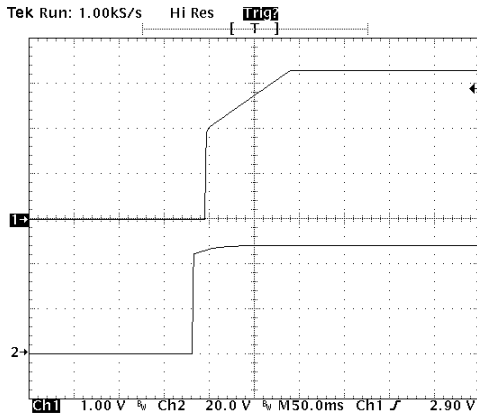

Typical Start-Up from Power On
AV60C-048L-050F06(-8)

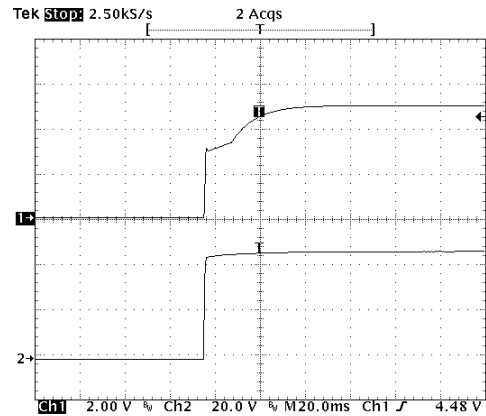

Typical Shut-down from Power Off
AV60C-048L-033F06(-8)

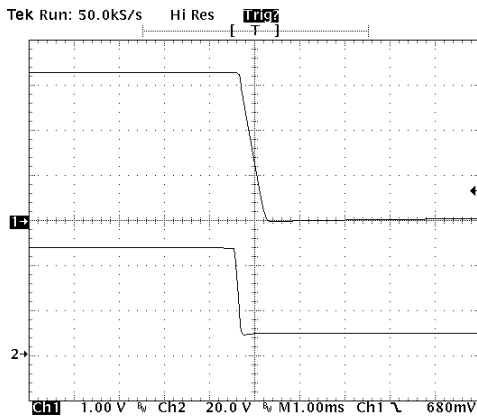

Typical Shut-down from Power Off
AV60C-048L-050F06(-8)

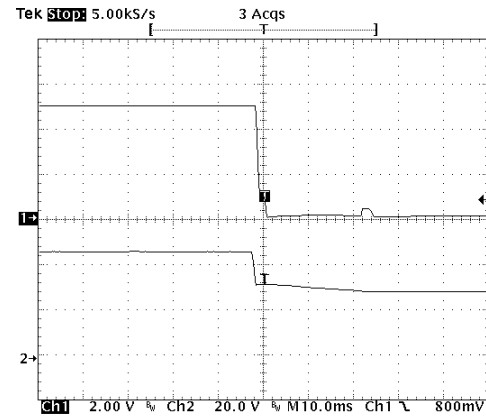

Characteristic Curves *(rated input voltage, full load, at 25 °C)*

Typical Start-Up from CNT Control
 AV60C-048L-033F06(-8)

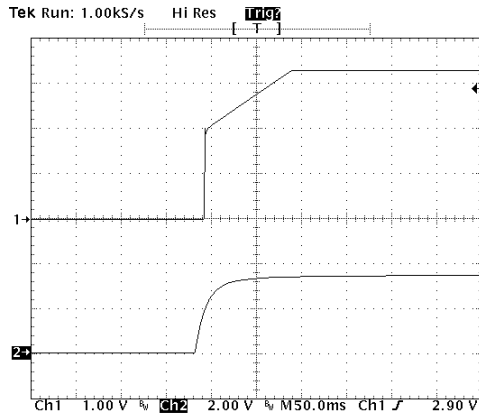

Typical Start-Up from CNT Control
 AV60C-048L-050F06(-8)

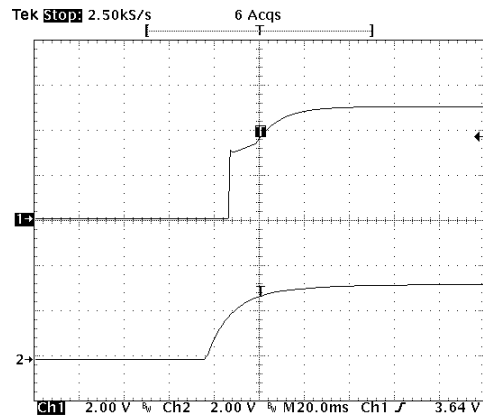

Typical Shut-down from CNT Control
 AV60C-048L-033F06(-8)

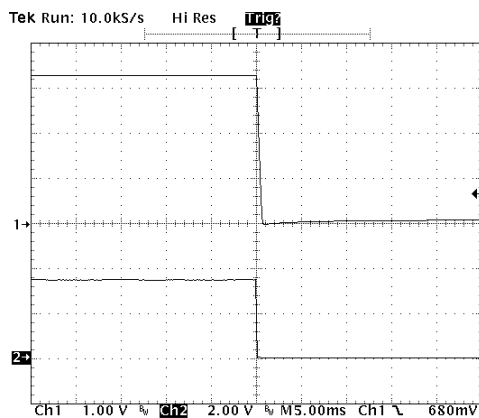

Typical Shut-down from CNT Control
 AV60C-048L-050F06(-8)

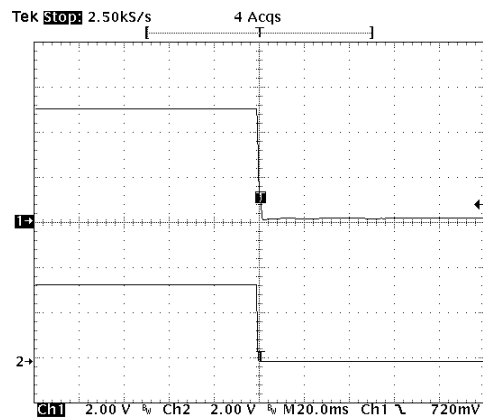

Characteristic Curves *(rated input voltage, full load, at 25 °C)*

**Typical Output Ripple Voltage
AV60C-048L-033F06(-8)**

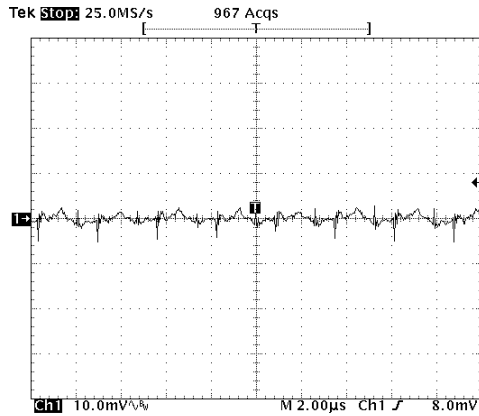

**Typical Output Ripple Voltage
AV60C-048L-050F06(-8)**

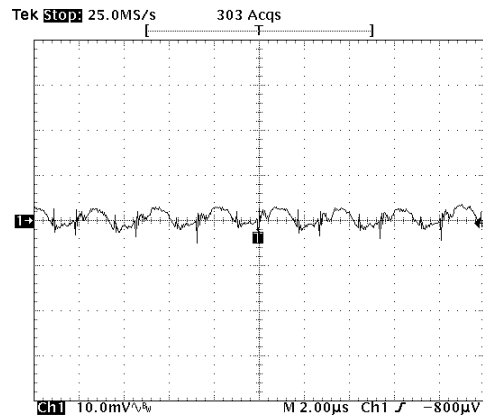

**Overvoltage Protection
AV60C-048L-033F06(-8)**

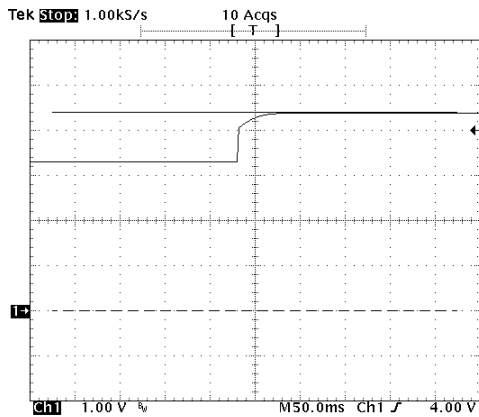

**Overvoltage Protection
AV60C-048L-050F06(-8)**

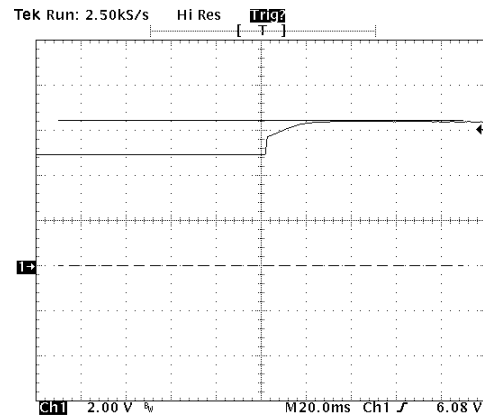

Characteristic Curves *(rated input voltage, full load, $C_i=47\mu F$, at 25 °C)*

Input Reflected Current
AV60C-048L-033F06(-8)

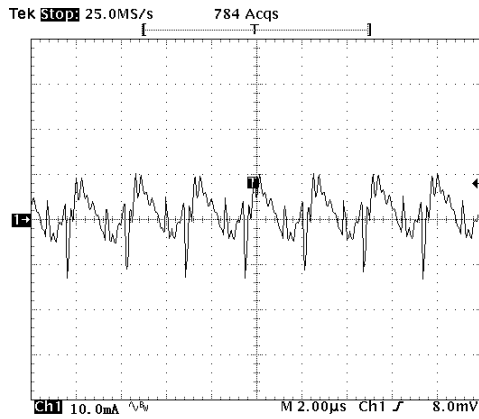

Input Reflected Current
AV60C-048L-050F06(-8)

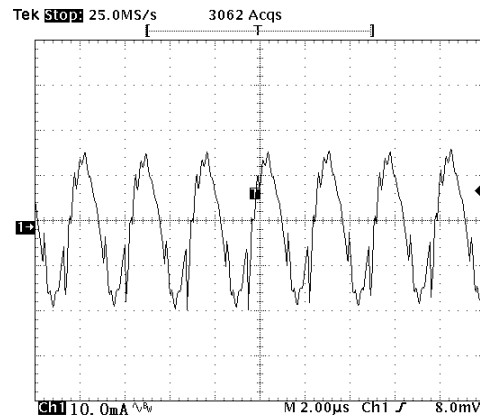

AV60C Half-Brick Size DC-DC Converters 36VDC to 75VDC Input, 30W Output

Pins

The +Vin and -Vin input connection pins are located as shown in Figure 1. AV60C-30W converters have a 2:1 input voltage range and 48 Vin converters can accept 36-75 Vdc. Care should be taken to avoid applying reverse polarity to the input which can damage the converter.

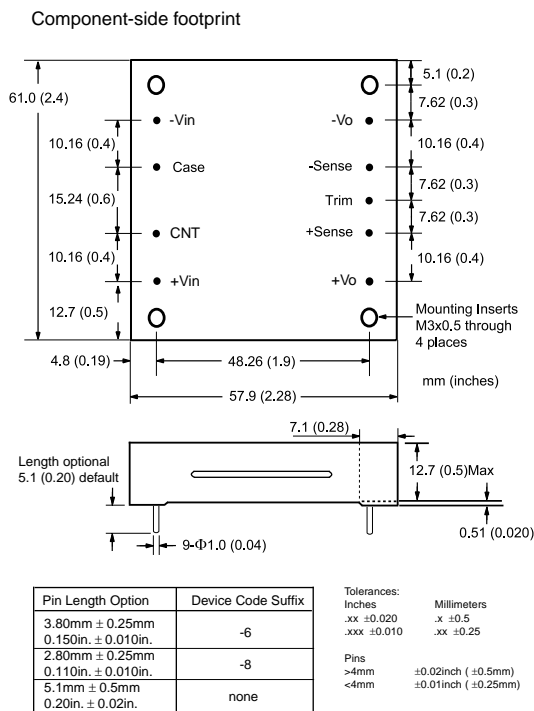

Fig.1 Dimensions

Input Characteristic

Fusing

The AV60C-30W power module have no internal fuse. An external fuse must always be employed! To meet international safety requirements, a 250 Volt rated fuse should be used. If one of the input lines is connected to chassis ground, then the fuse must be placed in the other input line.

Standard safety agency regulations require input fusing. Recommended fuse ratings for the AV60C-30W Series are shown in Table 1.

Table 1

Series	Input Current Max.	Fuse Rating (48Vin)
AV60C-048L-033F06	0.75A	5A
AV60C-048L-050F06	1.0A	5A

Input Reverse Voltage Protection

Under installation and cabling conditions where reverse polarity across the input may occur, reverse polarity protection is recommended. Protection can easily be provided as shown in Figure 2. In both cases the diode rating is determined by the power of the converter. Diodes should be rated at 5A/100V for AV60C-30W series. **Placing the diode across the inputs rather than in-line with the input offers an advantage in that the diode only conducts in a reverse polarity condition, which increases circuit efficiency and thermal performance.**

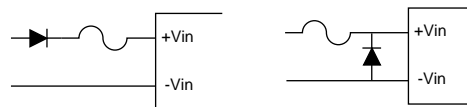

Fig.2 Reverse Polarity Protection Circuits

Input Undervoltage Protection

The AV60C-30W series is protected against undervoltage on the input. If the input voltage drops below the acceptable range, the converter will shut down. It will automatically restart when the undervoltage condition is removed.

Input Filter

Input filters are included in the converters to help achieve standard system emissions certifications. Some users however, may find that additional input filtering is necessary. The AV60C-30W series has an internal switching frequency of 370kHz so a high frequency capacitor mounted close to the input terminals produces the best results. To reduce reflected noise, a capacitor can be added across the input as shown in Figure 3, forming a π filter. A 47 μ F/100V electrolytic capacitor is recommended for C1.

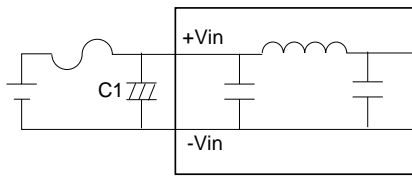

Fig.3 Ripple Rejection Input Filter

Control Function

Two remote CNT options are available.

Negative logic applying a voltage less than 1.2V to the CNT pin will enable the output, and applying a voltage greater than 3V will disable it.

Positive logic applying a voltage larger than 3V to the CNT pin will enable the output, and applying a voltage less than 1.2V will disable it. Negative logic, device code suffix " N ". Positive logic, device code suffix nothing is the factory-preferred.

If the CNT pin is left open, the converter will default to " control off " operation in negative logic, but default to " control on " in positive logic.

The maximum voltage that can be applied to the CNT pin is 6V.

The four different control circuits is as follows:

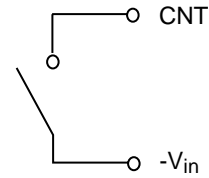

Fig.4 Simple CNT Control

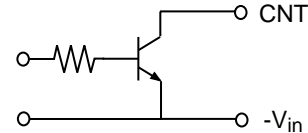

Fig.5 Transistor CNT Control

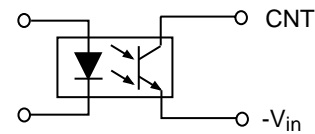

Fig.6 Isolated CNT Control

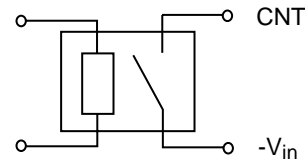

Fig.7 Relay CNT Control

Input-Output Characteristic

Safety Consideration

For safety-agency approval of the system in which the power module is used, the power module must be installed in compliance with the spacing and separation requirements of the end-use safety agency standard, i.e., UL1950, CSA C22.2 No. 950-95, and EN60950.

The input-to-output 1500VDC isolation is an operational insulation. The DC/DC power module should be installed in end-use equipment, in compliance with the requirements of the ultimate application, and is intended to be supplied by an isolated secondary circuit.

When the supply to the DC/DC power module meets all the requirements for SELV(<60Vdc),

the output is considered to remain within SELV limits (level 3). If connected to a 60Vdc power system, double or reinforced insulation must be provided in the power supply that isolates the input from any hazardous voltages, including the ac mains. One Vi pin and one Vo pin are to be grounded or both the input and output pins are to be kept floating. Single fault testing in the power supply must be performed in combination with the DC/DC power module to demonstrate that the output meets the requirement for SELV. The input pins of the module are not operator accessible.

Note: Do not ground either of the input pins of the module, without grounding one of the output pins. This may allow a non-SELV voltage to appear between the output pin and ground.

Case Grounding

For proper operation of the module, the case of the AV60C-30W series does not require a connection to a chassis ground. The case is not connected internally allowing the user flexibility in grounding. Whether to ground the case must be decided by safety considerations, and entirely determined by the final application. If the AV60C-30W series is not in a metallic enclosure in a system, it may be advisable to directly ground the case to reduce electric field emissions. Leaving the case floating can help to reduce magnetic field radiation from common mode noise currents. If the case has to be grounded for safety or other reasons, an inductor can be connected to chassis at DC and AC line frequencies, but be left floating at switching frequencies. Under this condition, the safety requirements are met and the emissions are minimized. In general, the inductor maintains a DC resistance from the case to chassis ground of no more than 0.1s during the safely conducting of all the available input current. All the

available input current refer to the value of the input fuse to the module. IEC 950 requires testing the DC resistance at 1.5 times that value. Specific safety requirements may dictate something different.

Output Characteristics

Minimum Load Requirement

There is a 10% (of full load) minimum load required in the main output.

The AV60C-30W series modules will maintain regulation and operate properly with a NO LOAD condition. However, the transient response is altered below a minimum output load condition. When the module is operating below the minimum load, the transient amplitude and recovery time are both increased when the load is stepped higher, the output ripple continues to meet the peak to peak requirements. For the AV60C-30W modules, the 10% minimum load requirement is strictly in order to meet all performance specifications, this is the 10% minimum load requirement.

Remote Sensing

The AV60C-30W converters can remotely sense both lines of its output which moves the effective output voltage regulation point from the output of the unit to the point of connection of the remote sense pins. This feature automatically adjusts the real output voltage of the AV60C-30W converters in order to compensate for voltage drops in distribution and maintain a regulated voltage at the point of load.

When the converter is supporting loads far away, or is used with undersized cabling, significant voltage drop can occur at the load. The best defense against such drops is to locate the load close to the converter and to ensure ade-

quately sized cabling is used. When this is not possible, the converter can compensate for a drop of up to 0.25V per lead, or a total of 0.5V, through use of the sense leads.

When used, the + and - sense leads should be connected from the converter to the point of

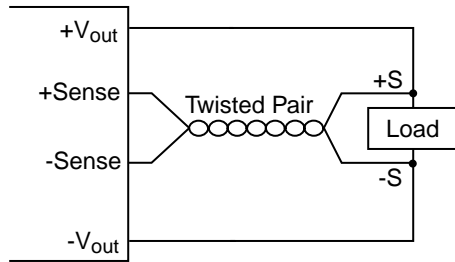

Fig.8 Sense Connections

load as shown in Figure 8 using twisted pair wire. The converter will then regulate its output voltage at the point where the leads are connected. Care should be taken not to reverse the sense leads. If reversed, the converter will trigger OVP protection. When not used, the +Sense lead must be connected with +Vo, and -Sense with -Vo. Also note that the output voltage and the remote sense voltage offset must be less than the minimum overvoltage trip point.

Note that at elevated output voltages the maximum power rating of the module remains the same, and the output current capability will decrease correspondingly.

Output Trimming

Users can increase or decrease the output voltage set point of a module by connecting an external resistor between the TRIM pin and either the SENSE (+) or SENSE (-) pins. The trim resistor should be positioned close to the module.

If not using the trim feature, leave the TRIM pin open.

Trimming up by more than 10% of the nominal output may damage the converter. Trimming down more than 20% can cause the converter to regulate improperly. Trim down and trim up circuits and the corresponding configuration are shown in Figure 9 to Figure 13.

The circuits and test results for the trim up and trim down configurations are displayed as following:

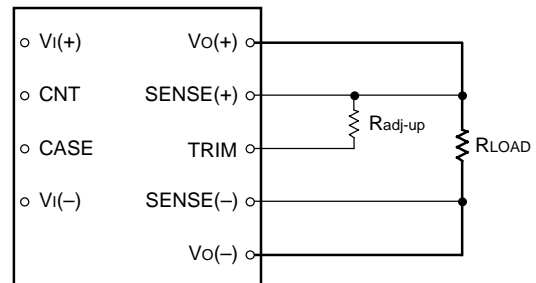

$$R_{adj-up} = \left(\frac{V_{o,nom}}{1.25} - 1 \right) \left(\frac{1 + y/100}{y/100} \right) 10$$

where y is the adjusting percentage of the voltage.
 0 < y < 10
 R_{adj-up} is in kΩ.

Fig.9 3.3V Output Trim Up Circuit

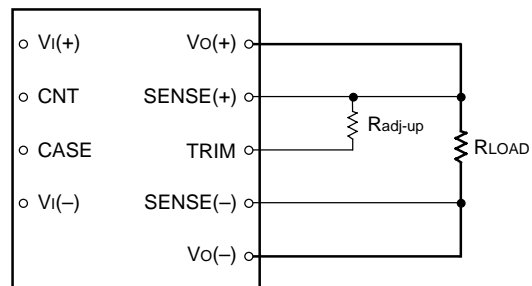

$$R_{adj-up} = \left(\frac{V_{o,nom}}{2.5} - 1 \right) \left(\frac{1 + y/100}{y/100} \right) 10$$

where y is the adjusting percentage of the voltage.
 0 < y < 10
 R_{adj-up} is in kΩ.

Fig.10 5V Output Trim Up Circuit

AV60C Half-Brick Size DC-DC Converters 36VDC to 75VDC Input, 30W Output

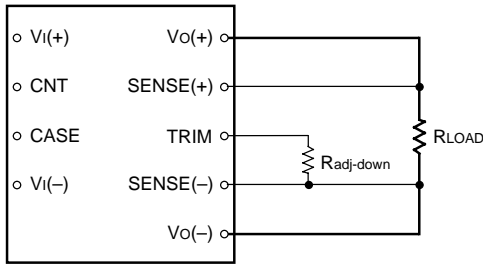

$$R_{\text{adj-down}} = \left(\frac{1 - y/100}{y/100} \right) 10$$

where y is the adjusting percentage of the voltage.
 $0 < y < 20$
 $R_{\text{adj-down}}$ is in $k\Omega$.

Fig.11 Trim Down Circuit

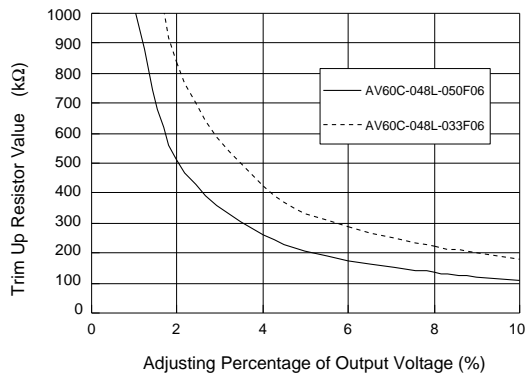

Fig.12 Trim Up Curves

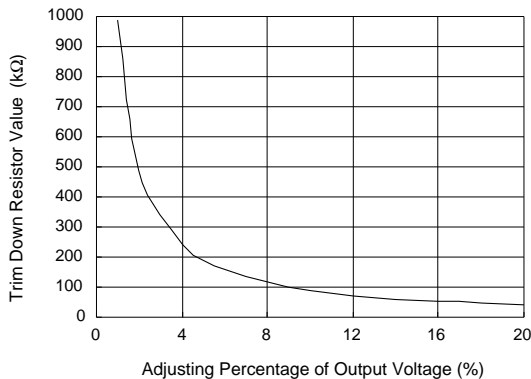

Fig.13 Trim Down Curves

Note that at elevated output voltages the maximum power rating of the module remains the same, and the output current capability will decrease correspondingly.

Output Over-Voltage Protection

The over-voltage protection has a separate feedback loop which activates when the output voltage is between 4.0V-5.7V for 3.3V output or 5.6V-7.0V for 5V output. When an over-voltage condition occurs, a signal was sent to the input of the module, and clamping the output.

Output Over-Current Protection

AV60C-30W series DC/DC converters feature foldback current limiting as part of their Overcurrent Protection (OCP) circuits. When output current exceeds 110 to 150% of rated current, such as during a short circuit condition, the output will shutdown immediately, and can tolerate short circuit conditions indefinitely. When the overcurrent condition is removed, the converter will automatically restart.

Output Filters

When the load is sensitive to ripple and noise, an output filter can be added to minimize the effects. A simple output filter to reduce output ripple and noise can be made by connecting a capacitor across the output as shown in Figure 14. The recommended value for the output capacitor C1 is 1000 μ F/25V.

Extra care should be taken when long leads or traces are used to provide power to the load. Long lead lengths increase the chance for noise to appear on the lines. Under these conditions C2 can be added across the load as shown in Figure 15. The recommended component for C2 is 1000 μ F/25V capacitor and connecting a 1 μ F ceramic capacitor C1 in parallel generally.

AV60C Half-Brick Size DC-DC Converters 36VDC to 75VDC Input, 30W Output

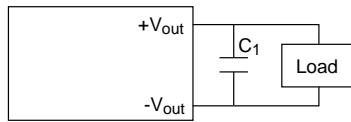

Fig.14 Output Ripple Filter

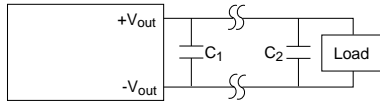

Fig.15 Output Ripple Filter For a Distant Load

Decoupling

Noise on the power distribution system is not always created by the converter. High speed analog or digital loads with dynamic power demands can cause noise to cross the power inductor back onto the input lines. Noise can be reduced by decoupling the load. In most cases, connecting a 10 μF tantalum capacitor in parallel with a 1 μF ceramic capacitor across the load will decouple it. The capacitors should be connected as close to the load as possible.

Ground Loops

Ground loops occur when different circuits are given multiple paths to common or earth ground, as shown in Figure 16. Multiple ground points can slightly different potential and cause current flow through the circuit from one point to another. This can result in additional noise in all the circuits. To eliminate the problem, circuits should be designed with a single ground connection as shown in Figure 17.

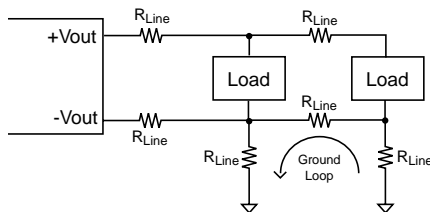

Fig.16 Ground Loops

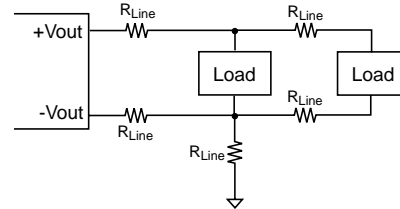

Fig.17 Single Point Ground

Parallel Power Distribution

Figure 18. shows a typical parallel power distribution design. Such designs, sometimes called daisy chains, can be used for very low output currents, but are not normally recommended. The voltage across loads far from the source can vary greatly depending on the IR drops along the leads and changes in the loads closer to the source. Dynamic load conditions increase the potential problems.

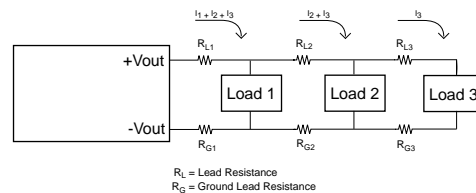

Fig.18 Parallel Power Distribution

Radial Power Distribution

Radial power distribution is the preferred method of providing power to the load. Figure 19. shows how individual loads are connected directly to the power source. This arrangement requires additional power leads, but it avoids the voltage variation problems associated with the parallel power distribution technique.

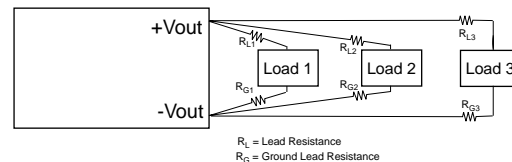

Fig.19 Radial Power Distribution

USA

TEL: 1-760-930-4600

FAX: 1-760-930-0698

Europe

44-(0)1384-842-211

44-(0)1384-843-355

Asia

852-2437-9662

852-2402-4426

www.astec.com



Mixed Distribution

In the real world a combination of parallel and radial power distribution is often used. Dynamic and high current loads are connected using a radial design, while static and low current loads can be connected in parallel. This combined approach minimizes the drawbacks of a parallel design when a purely radial design is not feasible.

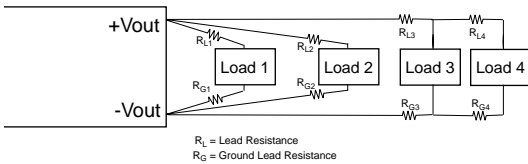

Fig.20 Mixed Power Distribution

Redundant Operation

A common requirement in high reliability systems is to provide redundant power supplies. The easiest way to do this is to place two converters in parallel, providing fault tolerance but not load sharing. Oring diodes should be used to ensure that failure of one converter will not cause failure of the second. Figure 21 shows such an arrangement. Upon application of power, one of the converters will provide a slightly higher output voltage and will support the full load demand. The second converter will see a zero load condition and will “idle”. If the first converter should fail, the second converter will support the full load. When designing redundant converter circuits, Schottky diodes should be used to minimize the forward voltage drop. The voltage drop across the Schottky diodes must also be considered when determining load voltage requirements.

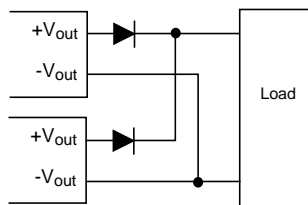

Fig.21 Redundant Operation

Thermal Management

Technologies

AV60C-30W Series feature high efficiency and the 5 V output units have typical efficiency of 87% at full load. With less heat dissipation and temperature-resistant components such as ceramic capacitors, these modules exhibit good behavior during prolonged exposure to high temperatures. Maintaining the operating case temperature (T_c) within the specified range help keep internal-component temperatures within their specifications which in turn help keep MTBF from falling below the specified rating. Proper cooling of the power modules is also necessary for reliable and consistent operation.

Basic Thermal Management

Measuring the case temperature of the module (T_c) as the method shown in Figure 22 can verify the proper cooling. Figure 22 shows the metal surface of the module and the pin locations. The module should work under 62°C in natural convection for the reliability of operation and T_c must not exceed 100 °C while operating in the final system configuration. The measurement can be made with a surface probe after

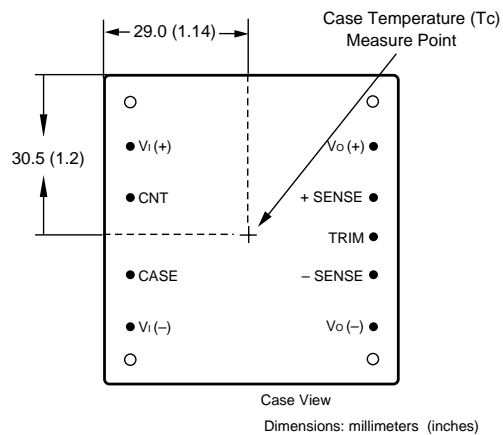

Fig.22 Case Temperature Measurement

AV60C Half-Brick Size DC-DC Converters 36VDC to 75VDC Input, 30W Output

the module has reached thermal equilibrium. If a heat sink is mounted to the case, make the measurement as close as possible to the indicated position. It makes the assumption that the final system configuration exists and can be used for a test environment.

The following text and graphs show guidelines to predict the thermal performance of the module for typical configurations that include heat sinks in natural or forced airflow environments. Note that T_c of module must always be checked in the final system configuration to verify proper operational due to the variation in test conditions.

Thermal management acts to transfer the heat dissipated by the module to the surrounding environment. The amount of power dissipated by the module as heat (P_D) is got by the equation below:

$$P_D = P_i - P_o$$

where : P_i is input power;

P_o is output power;

P_D is dissipated power.

Also, module efficiency (η) is defined as the following equation:

$$\eta = P_o / P_i$$

If eliminating the input power term, from two above equations can yield the equation below:

$$P_D = P_o (1 - \eta) / \eta$$

The module power dissipation then can be calculated through the equation.

Because each power module output voltage has a different power dissipation curve, a plot of power dissipation versus output current over three different line voltages is given in each-module-specific data sheet. The typical power dissipation curve of AV60C-30W series 3.3V and 5V output are shown as figure 23 to figure 24.

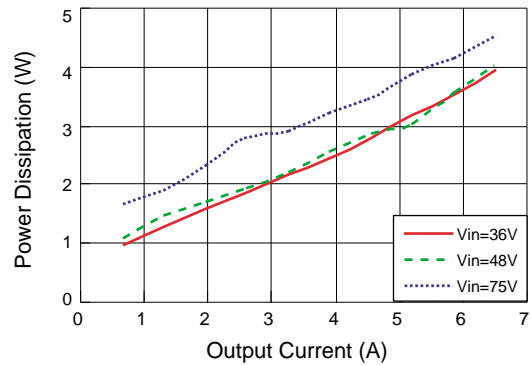

Fig.23 AV60C-048L-033F06 Power Dissipation Curves

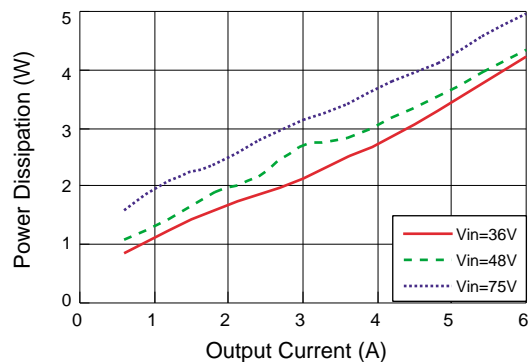

Fig.24 AV60C-048L-050F06 Power Dissipation Curves

Module Derating

Experiment Setup

From the experimental set up shown in figure 25, the derating curves as figure 26 can be drawn. Note that the PWB (printed-wiring board) and the module must be mounted vertically. The passage has a rectangular cross-section. The clearance between the facing PWB and the top of the module is kept 13 mm (0.5 in.) constantly.

AV60C Half-Brick Size DC-DC Converters 36VDC to 75VDC Input, 30W Output

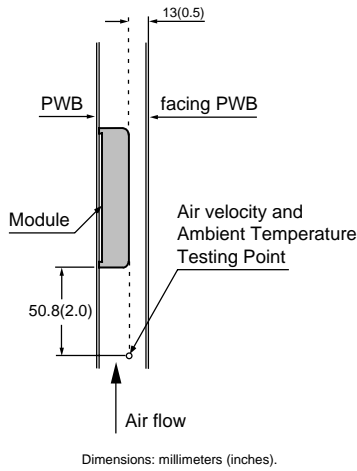

Fig.25 Experiment Set Up

Convection Without Heat Sinks

Heat transfer can be enhanced by increasing the airflow over the module. Figure 26 shows the maximum power that can be dissipated by the module.

In the test, natural convection airflow was measured at 0.05 m/s to 0.1 m/s (10 ft./min. to 20 ft./min.). The 0.5 m/s to 2.0 m/s (100 ft./min. to 400 ft./min.) curves are tested with externally adjustable fans. The appropriate airflow for a given operating condition can be determined through figure 26.

To determine the necessary airflow, determine

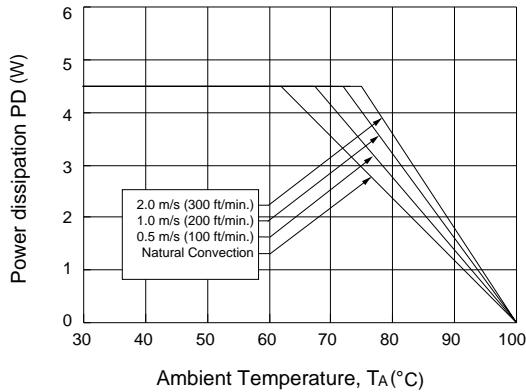

Fig.26 Forced Convection Power Derating without Heat Sink

the power dissipated by the unit for the particular application. Figures 23 to 24 show typical power dissipation for these power modules over a range of output currents. With the know power dissipation and a given local ambient temperature, the appropriate air flow can be chosen from the derating curves in Figure 26. For example, if the AV60C-048L-050F06 dissipates 3.0W, the minimum airflow in a 80°C environment is 1 ms⁻¹ (200ft./min).

Heat Sink Configuration

Several standard heat sinks are available for the AV60C-30W series as shown in Figure 27 to Figure 29.

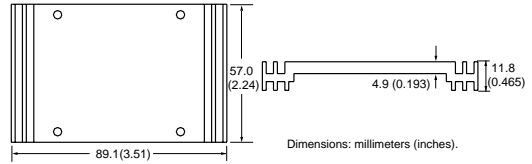

Fig.27 Non Standard Heatsink

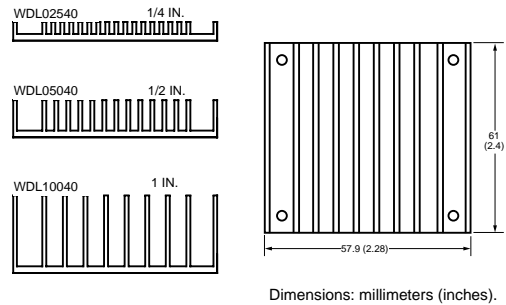

Fig.28 Longitudinal Fins Heat Sink

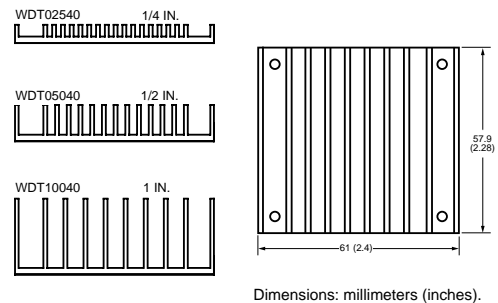

Fig.29 Transverse Fins Heat Sink

AV60C Half-Brick Size DC-DC Converters 36VDC to 75VDC Input, 30W Output

The heat sinks mount to the top surface of the module with screws torqued to 0.56 N-m (5 in.-lb). A thermally conductive dry pad or thermal grease is placed between the case and the heat sink to minimize contact resistance (typically 0.1°C/W to 0.3°C/W) and temperature differential.

Nomenclature for heat sink configurations is as follows:

WDxyyy40

where:

x = fin orientation: longitudinal (L) or transverse (T)

yyy = heat sink height (in 100ths of inch)

For example, WDT5040 is a heat sink that is transverse mounted (see Figure 29) for a 61 mm x 57.9 mm (2.4 in.x 2.28 in.) module with a heat sink height of 0.5 in.

Heatsink Mounting Advice

A crucial part of the thermal design strategy is the thermal interface between the case of the module and the heatsink. Inadequate measures taken here will quickly negate any other attempts to control the case temperature. For example, using a conventional dry insulator can result in a case-heatsink thermal impedance of >0.5°C/W, while use one of the recommended

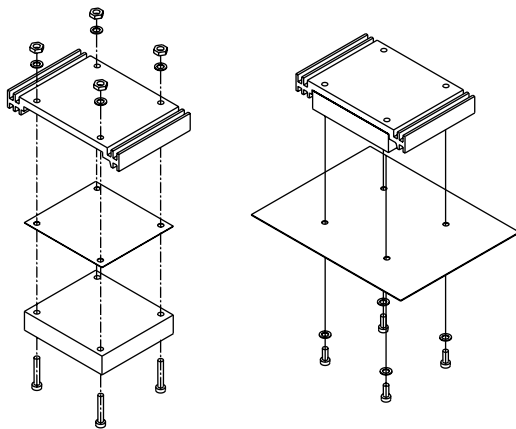

Fig.30 Heat Sink Mounting

interface methods (silicon grease or thermal pads available from Avansys) can result in a case-heatsink thermal impedance around 0.1°C/W.

Natural Convection with Heat Sink

The power derating for a module with the heat sinks (shown as figure 27 to figure 29) in natural convection is shown in figure 31. In this test, natural convection generates airflow about 0.05 m/s to 0.1 m/s (10ft./min to 20ft./min).

Figure 31 can be used for heat-sink selection in natural convection environment.

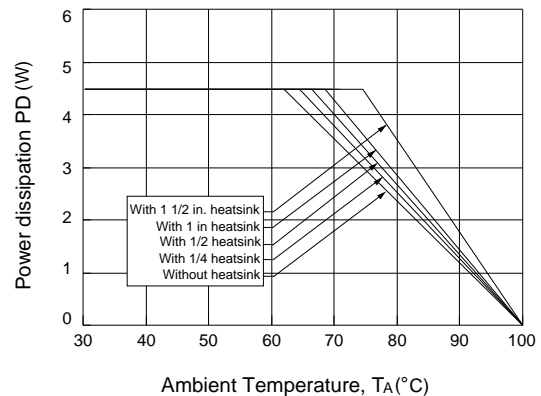

Fig.31 Heat Sink Power Derating Curves, Natural Convection

For example how to select a heat sink?

What heat sink would be appropriate for a AV60C-048L-050F06 in a natural convection environment at nominal line, 3/4 load, and maximum ambient temperature of 80°C?

Determine P_D (referenced **Fig.22**) with condition:

$$V_I = 48 \text{ V}$$

$$I_O = 3/4 (6.0) = 4.5 \text{ A}$$

$$T_A = 80 \text{ }^\circ\text{C}$$

Get: $P_D = 3.2 \text{ W}$

Determine Heat Sink (Fig.31):

1 1/2 in. allows up to $T_A = 82^\circ\text{C}$

AV60C Half-Brick Size DC-DC Converters 36VDC to 75VDC Input, 30W Output

Basic Thermal Model

There is another approach to analyze module thermal performance, to model case to ambient thermal resistance ($^{\circ}\text{C}/\text{W}$), for these module. This presentation method is especially useful when considering heat sinks. The following equation can be used to calculate the total thermal resistance .

$$R_{CA} = \Delta T_{C, \max} / P_D$$

Where R_{CA} is the module thermal resistance;

$\Delta T_{C, \max}$ is the maximum case temperature rise;

P_D is the module power dissipation.

In this model, P_D , $\Delta T_{C, \max}$, and R_{CA} are equals to current flow, voltage drop, and electrical resistance, respectively, in Ohm's law, as shown in Figure 32. Also, $\Delta T_{C, \max}$ is defined as the difference between the module case temperature (T_C) and the inlet ambient temperature (T_A).

$$\Delta T_{C, \max} = T_C - T_A$$

Where T_C is the module case temperature;

T_A is the inlet ambient temperature.

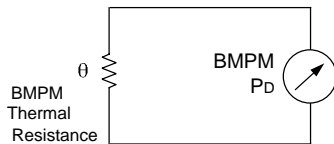

Fig.32 Basic Thermal Resistance Model

For AV60C-30W Series 5V output converters, the module's thermal resistance values versus air velocity have been determined experimentally and shown in figure 33. The highest values on each curve represents the point of natural convection.

Figure 33 is used for determining thermal performance under various conditions of airflow and heat sink configurations.

For example, how to determine the allowable minimum airflow to heat sink combina-

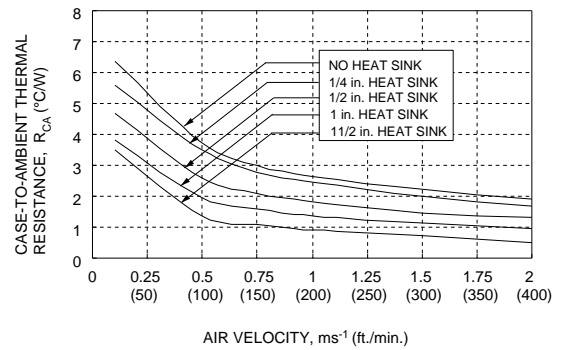

Fig.33 Case-to-Ambient Thermal Resistance Curves; Either Orientation

tions necessary for a module under a desired T_c and a certain condition?

Although the maximum case temperature for the AV60C-30W Series converters is 100°C , you can improve module reliability by limiting $T_{c,\max}$ to a lower value. How to decide? For example, what is the allowable minimum airflow for AV60C-048L-050F06 heat sink combinations at desired T_c of 80°C ?

The working condition is as following:

$$V_i = 48 \text{ V}, I_o = 5 \text{ A}, T_A = 70^{\circ}\text{C}$$

Determine P_D (Fig.24.)

$$P_D = 3.7 \text{ W}$$

Then solve R_{CA} :

$$R_{CA} = \Delta T_{C, \max} / P_D$$

$$R_{CA} = (T_C - T_A) / P_D$$

$$R_{CA} = (80 - 70) / 3.7 = 2.7^{\circ}\text{C}/\text{W}$$

determine air velocity from figure 33:

If no heat sink:

$$v > 1.0 \text{ m/s (200 ft./min.)}$$

If 1/4 in. heat sink:

$$v > 0.8 \text{ m/s (160 ft./min.)}$$

If 1/2 in. heat sink:

$$v > 0.5\text{m/s (100 ft./min.)}$$

If 1 in. heat sink:

$$v > 0.3 \text{ m/s (60 ft./min.)}$$

If 1 1/2 in. heat sink:

$$v > 0.25 \text{ m/s (50 ft./min.)}$$

How to select heatsink for a particular environment?

For example, if the AV60C-048L-050F06 dissipates 4.0w of heat in an 90°C environment with an airflow of 0.8ms⁻¹ (160ft./min.). The minimum heatsink required can be determined as follows:

$$R_{CA} \leq (T_{C,max} - T_A) / P_D$$

where:

$T_{C,max}$ = case temperature (see figure 20)

$$R_{CA} \leq (100-90)/4.0$$

$$R_{CA} \leq 2.5^\circ\text{C/w}$$

From figure 33, the 1/2 in. high heatsink or greater is required.

MTBF

The MTBF, calculated in accordance with Bellcore TR-NWT-000332 is 1,750,000 hours. The test condition is as following: 40°C case temperature, 80%Io,max, natural convection. ASTEC can supply replacements for converters from other manufacturers, or offer custom solutions. Please contact the factory for details.

AV60C-30W Series

Mechanical Considerations

Installation

Although AV60C-30W converters can be mounted in any orientation, free air-flowing must be taken. Normally power components are always put at the end of the airflow path or have the separate airflow paths. This can keep other system equipment cooler and increase component life spans.

Soldering

AV60C-30W converters are compatible with standard wave soldering techniques. When wave soldering, the converter pins should be preheated for 20-30 seconds at 110°C, and wave soldered at 260°C for less than 10 seconds. When hand soldering, the iron temperature should be maintained at 425°C and applied to the converter pins for less than 5 seconds. Longer exposure can cause internal damage to the converter. Cleaning can be performed with cleaning solvent IPA or with water.

USA

TEL: 1-760-930-4600

FAX: 1-760-930-0698

Europe

44-(0)1384-842-211

44-(0)1384-843-355

Asia

852-2437-9662

852-2402-4426

www.astec.com



**AV60C Half-Brick Size DC-DC Converters
36VDC to 75VDC Input, 30W Output**

Recommend Hole Pattern

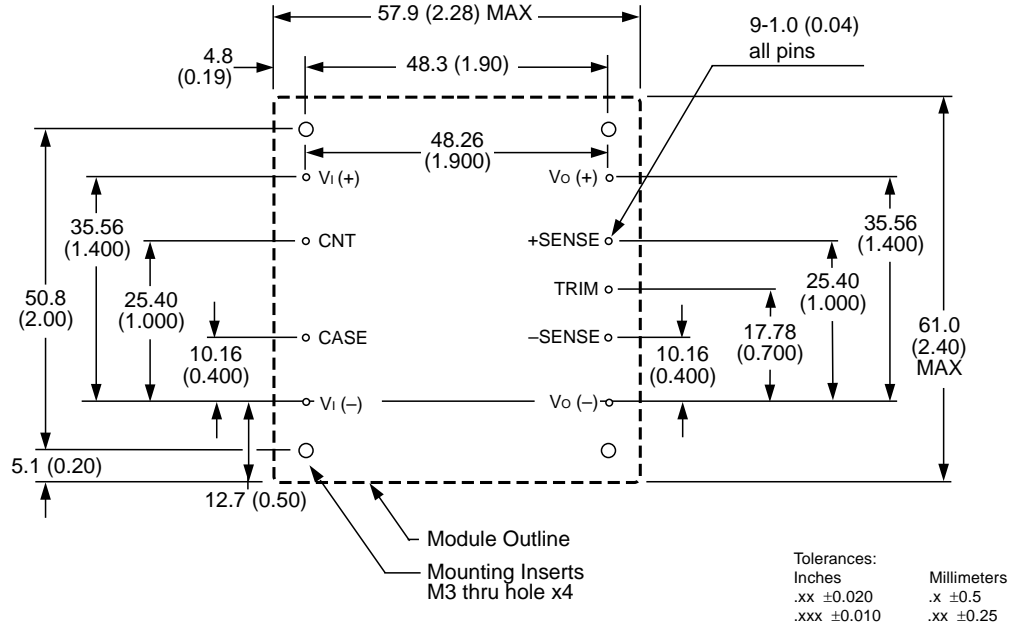

Dimensions are in millimeters and (inches).

USA

TEL: 1-760-930-4600

FAX: 1-760-930-0698

Europe

44-(0)1384-842-211

44-(0)1384-843-355

Asia

852-2437-9662

852-2402-4426

www.astec.com



PART NUMBER DESCRIPTION

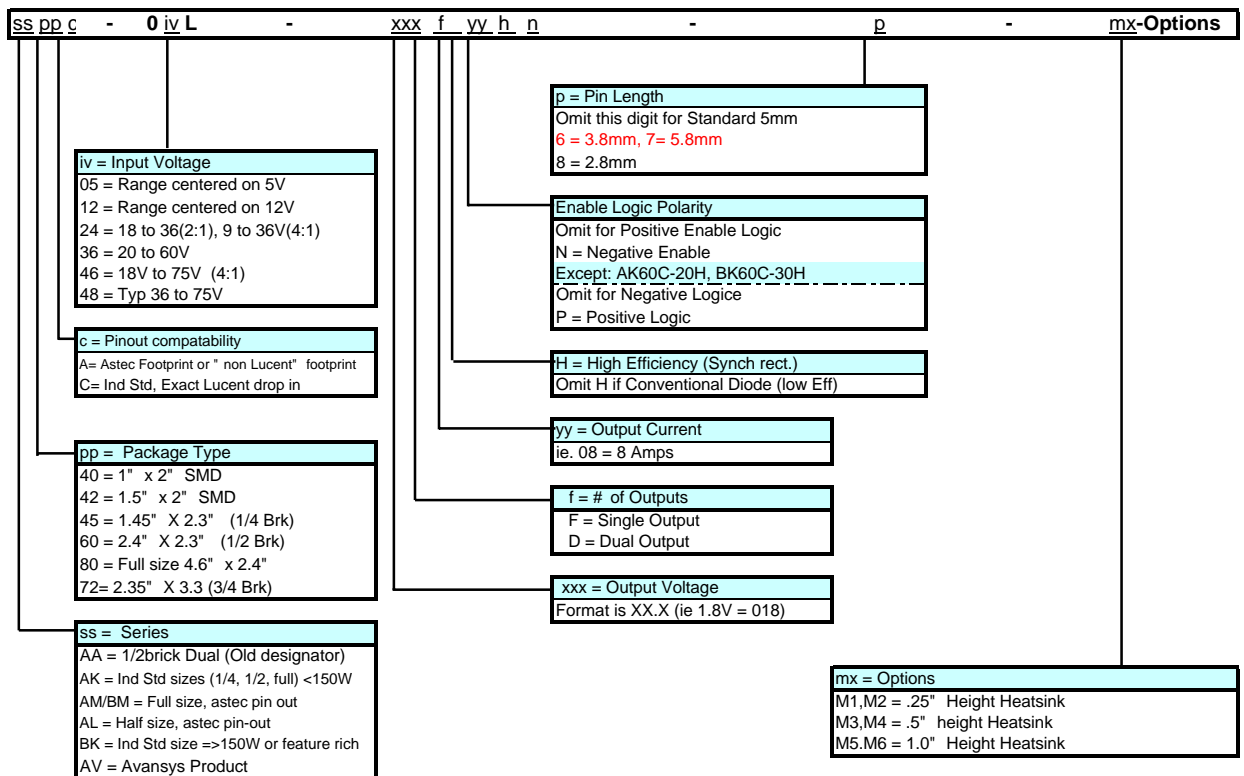

Note: For some products, they may not conform with the PART NUMBER DESCRIPTION above absolutely.

NEW PART NUMBER DESCRIPTION

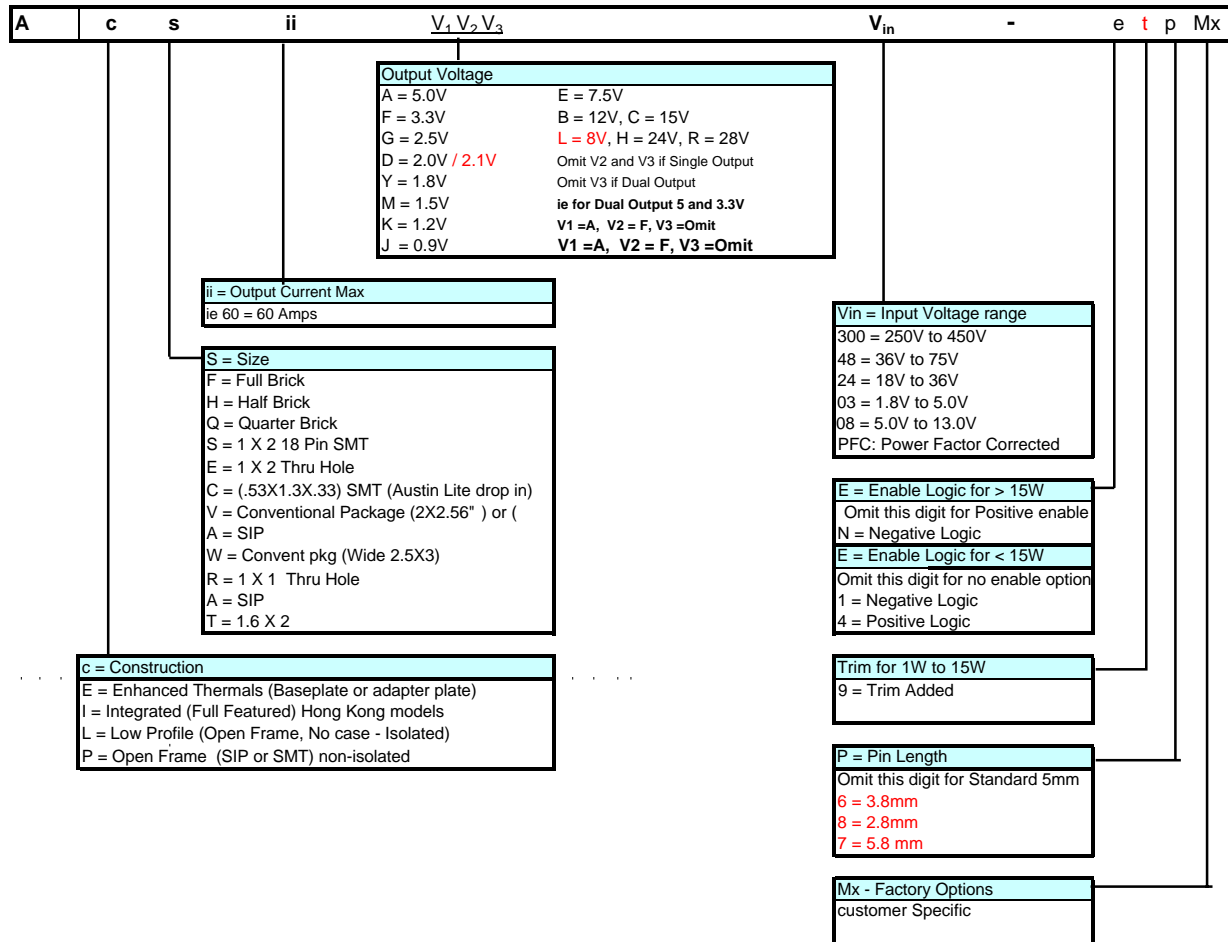

Note: For some products, they may not conform with the NEW PART NUMBER DESCRIPTION above absolutely.