

## NON-ISOLATED DC/DC CONVERTERS

8.3 Vdc - 14 Vdc Input

0.75 Vdc - 5.5 Vdc/6 A Output

**bel**  
POWER PRODUCTS

SRBA-06A2Ax

RoHS Compliant

Rev.A

- Non-Isolated
- High Efficiency
- High Power Density
- Fixed Frequency
- Remote On/Off
- Active Low/High
- Under-Voltage Lockout (UVLO)
- OCP/SCP
- Wide Input
- Wide Trim Range
- Flexible Output Voltage Sequencing



### Description

The Bel SRBA-06A2Ax modules are a series of non-isolated dc/dc converters that deliver up to 6 A of output current with full load efficiency of 92% at 5.0 Vdc output. These modules provide precisely regulated voltage programmable via external resistor from 0.75 Vdc to 5.5 Vdc over a wide range of input voltage (8.3 Vdc - 14 Vdc). These modules have a sequencing feature that enables designers to implement various types of output voltage sequencing when powering multiple voltages on a board. The open-frame construction and small footprint enable designers to develop cost and space-efficient solutions. Standard features include remote On/Off, over current protection, short current protection, wide input, and programmable output voltage.

### Part Selection

Output Voltage	Input Voltage	Max. Output Current	Max. Output Power	Typical Efficiency	Model Number Active Low	Model Number Active High
0.75 V - 5.5 V	8.3 V - 14 V	6 A	33 W	92%	SRBA-06A2AL	SRBA-06A2A0

**Notes:** 1. Add "G" suffix at the end of the model numbers listed above to indicate "Tray Packaging"  
2. All part numbers above indicate RoHS 6. Change the second letter "R" to "7" for RoHS 5 part numbers.

### Absolute Maximum Ratings

Parameter	Min	Typ	Max	Notes
Input Voltage (continuous)	-0.3 V	-	15 V	
Output Enable Terminal Voltage	-0.3 V	-	15 V	
Sequencing Voltage <sup>1</sup>	-0.3 V	-	V <sub>in</sub>	
Ambient Temperature	-40 °C	-	85 °C	
Storage Temperature	-55 °C	-	125 °C	

**Notes:** All specifications are typical at 25 °C unless otherwise stated.  
1. SRBA-06A2Ax series of modules include a sequencing feature that enables users to implement various types of output voltage sequencing in their applications. This is accomplished via an additional sequencing pin. When the sequencing feature is not used, tie the SEQ pin to V<sub>in</sub> or leave the SEQ pin floating.

# NON-ISOLATED DC/DC CONVERTERS

8.3 Vdc - 14 Vdc Input      0.75 Vdc - 5.5 Vdc/6 A Output



## Input Specifications

Parameter	Min	Typ	Max	Notes
Input Voltage	8.3 V	12 V	14 V	
Input Current (full load)				
Vo=5.0 V	-	2.75 A	4.0 A	
Vo=3.3 V	-	1.85 A	2.8 A	
Vo=2.5 V	-	1.45 A	2.2 A	
Vo=1.8 V	-	1.05 A	1.6 A	
Vo=1.2 V	-	0.75 A	1.1 A	
Vo=0.75 V	-	0.55 A	0.8 A	
Input Current (no load)				
Vo=5.0 V	-	-	100 mA	
Vo=0.75 V	-	-	20 mA	
Remote Off Input Current	-	1 mA	2 mA	
Input Reflected Ripple Current (pk-pk)	-	120 mA	-	Tested with two 100 uF/25 V tan input capacitors & simulated source impedance of 1 uH, 5 Hz to 20 MHz.
Input Reflected Ripple Current (rms)	-	40 mA	-	
I <sup>2</sup> t Inrush Current Transient	-	0.002 A <sup>2</sup> s	0.02 A <sup>2</sup> s	
Turn-on Voltage Threshold	-	8.1 V	8.2 V	
Turn-off Voltage Threshold	-	7.5 V	8.0 V	

**Notes:** All specifications are typical at 25 °C unless otherwise stated.

## Output Specifications

Parameter	Min	Typ	Max	Notes
Output Voltage Set Point	-2%Vo,set	-	2%Vo,set	Vin=12 V, full load
Output Voltage Set Point	-2.5%Vo,set	-	3.5%Vo,set	Over all operating input voltages, resistive loads and temperature conditions
Adjustment Range Selected by External Resistor or Voltage	0.7525 V	-	5.5 V	
Load Regulation	-	0.4%Vo,set	-	Io=Io, min to Io, max
Line Regulation	-	0.3%Vo,set	-	Vin=Vin, min to Vin, max
Regulation Over Temperature (-40 °C to +85 °C)	-	0.5%Vo,set	-	Tref=Ta, min to Ta, max
Output Current	0 A	-	6 A	
Current Limit Threshold	7.2 A	-	18 A	
Short Circuit Surge Transient	-	0.25 A <sup>2</sup> s	-	
Ripple and Noise (pk-pk) Vo=0.75 V-3.63 V	-	50 mV	75 mV	Tested with 0-20 MHz, with 10 uF/10 V tantalum capacitor & 1 uF/10 V TDK ceramic capacitor at the output.
Ripple and Noise (rms) Vo=0.75 V-3.63 V	-	15 mV	30 mV	
Ripple and Noise (pk-pk) Vo=5.0 V	-	75 mV	100 mV	
Ripple and Noise (rms) Vo=5.0 V	-	30 mV	40 mV	
Turn on Time	-	8 mS	10 mS	
Overshoot at Turn on	-	0%	3%	
Output Capacitance				
ESR ≥ 1 mohm	0 uF	-	1000 uF	
ESR ≥ 10 mohm	0 uF	-	3000 uF	

## NON-ISOLATED DC/DC CONVERTERS

8.3 Vdc - 14 Vdc Input      0.75 Vdc - 5.5 Vdc/6 A Output



### Output Specifications (continued)

Parameter	Min	Typ	Max	Notes
<b>Transient Response</b>				
50% ~ 100% Max Load	V <sub>O</sub> = 0.75 - 5.5 V	-	200 mV	di/dt=2.5 A/uS; Vin=12 V; and with 10 uF/10 V tantalum capacitor & 1 uF/ 10 V ceramic capacitor at the output.
Settling Time		-	50 uS	
100% ~ 50% Max Load		-	200 mV	
Settling Time		-	50 uS	

**Note:** All specifications are typical at nominal input (Vin=12 V), full load at 25 °C unless otherwise stated.

### General Specifications

Parameter	Min	Typ	Max	Notes
Efficiency				Measured at Vin=12 V, full load
V <sub>O</sub> =5.0 V	90%	92%	-	
V <sub>O</sub> =3.3 V	87%	89%	-	
V <sub>O</sub> =2.5 V	85%	88%	-	
V <sub>O</sub> =1.8 V	83%	86%	-	
V <sub>O</sub> =1.2 V	79%	82%	-	
V <sub>O</sub> =0.75 V	71%	74%	-	
Switching Frequency	250 kHz	300 kHz	350 kHz	
Over Temperature Shutdown	-	135 °C	-	
Output Trim Range (wide trim)	0.7525 V	-	5.5 V	
MTBF	3,079,469 hours			Calculated Per Bell Core SR-332 (I <sub>o</sub> = Nominal; T <sub>a</sub> = 25 °C)
Dimensions				
Inches (L x W x H)	0.8 x 0.45 x 0.251			
Millimeters (L x W x H)	20.32 x 11.42 x 6.38			
Weight	-	3 g	-	

**Note:** All specifications are typical at 25 °C unless otherwise stated.

### Control Specifications

Parameter	Min	Typ	Max	Notes
Signal Low (Unit Off)	-0.3 V	-	0.4 V	SRBA-06A2A0; Remote On/Off pin open, Unit on.
Signal High (Unit On)	2.5 V	-	14 V	
Signal Low (Unit On)	-0.3 V	-	0.4 V	SRBA-06A2AL; Remote On/Off pin open, Unit on.
Signal High (Unit Off)	2.5 V	-	14 V	
Sequencing Voltage	0 V	-	V <sub>in</sub>	Sequencing Voltage applied on SEQ pin should be higher than output voltage.
Sequencing Slew Rate Capability	-	-	2 V/mS	
Sequencing Delay Time	10 mS	-	-	Delay from V <sub>in</sub> , min to application of voltage on SEQ pin
Tracking Accuracy				
Power-Up	-	100 mV	200 mV	
Power-Down	-	200 mV	400 mV	

### Output Trim Equations

Equation for calculating the trim resistor (in kΩ) given the desired adjusted voltage (V<sub>adj</sub>) is shown below. The Trim Up resistor should be connected between the Trim pin and Ground.

$$R_{trim} = \frac{10.507}{V_{adj} - 0.7525} - 1$$

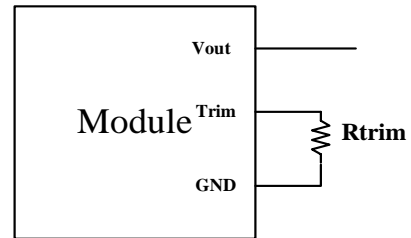

Equation for calculating the trim voltage (in V) given the desired adjusted voltage (V<sub>adj</sub>) is shown below. The Trim Up voltage should be connected between the Trim pin and Ground.

$$V_{trim} = 0.7 - 0.0667 \times (V_{adj} - 0.7525)$$

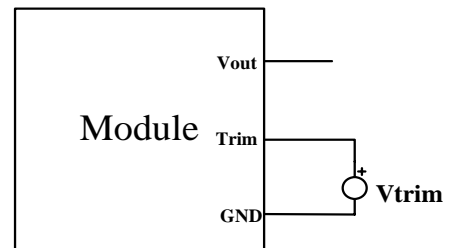

**NON-ISOLATED DC/DC CONVERTERS**  
 8.3 Vdc - 14 Vdc Input      0.75 Vdc - 5.5 Vdc/6 A Output



**Efficiency Data**

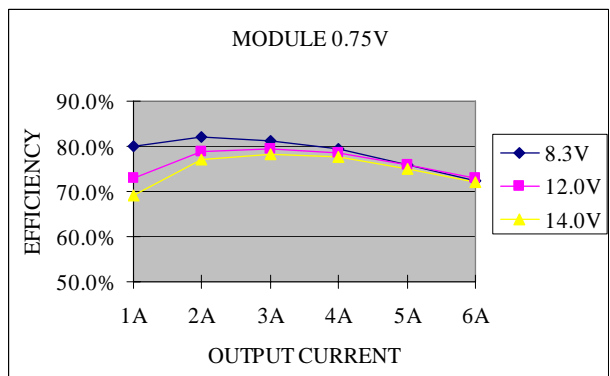
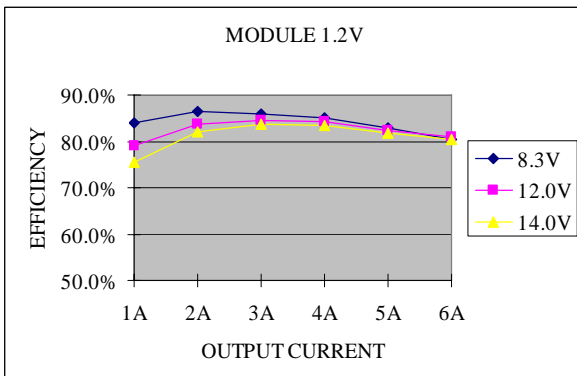
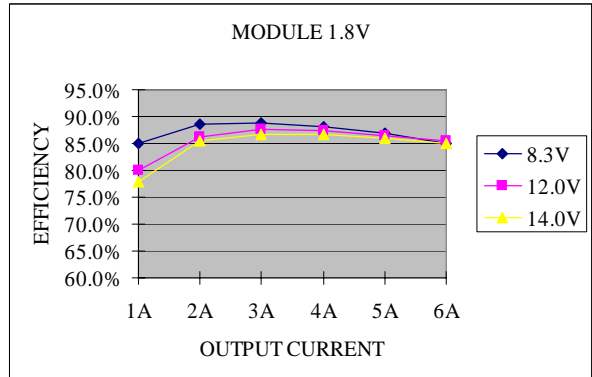
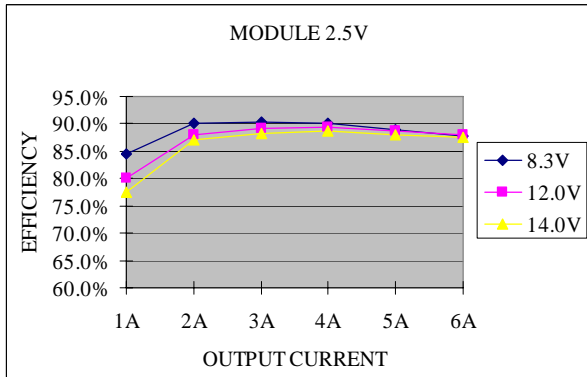
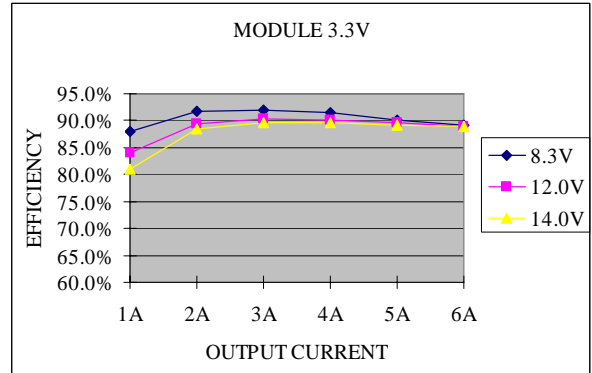
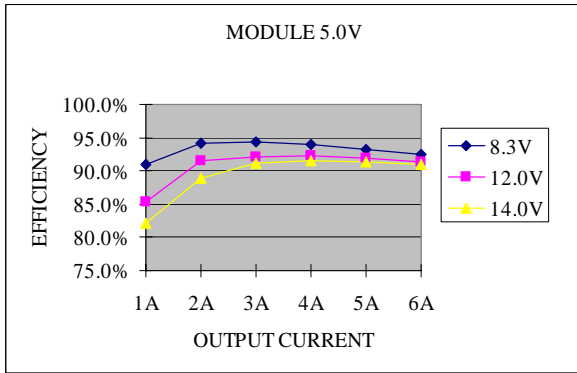

**NON-ISOLATED DC/DC CONVERTERS**  
 8.3 Vdc - 14 Vdc Input      0.75 Vdc - 5.5 Vdc/6 A Output



**Thermal Derating Curves**

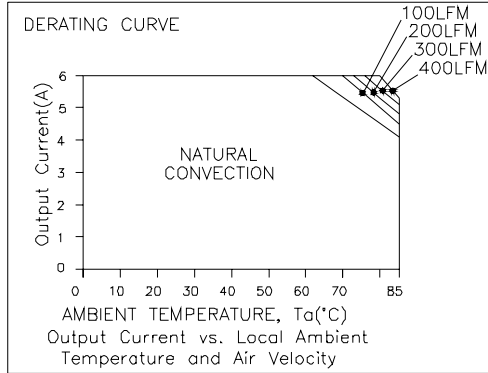

$V_{in}=12\text{ V}, V_o=0.75\text{ V}$

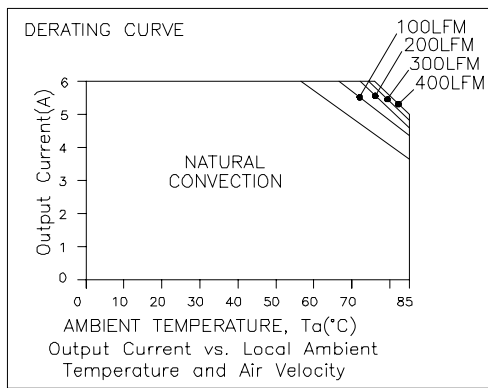

$V_{in}=12\text{ V}, V_o=2.5\text{ V}$

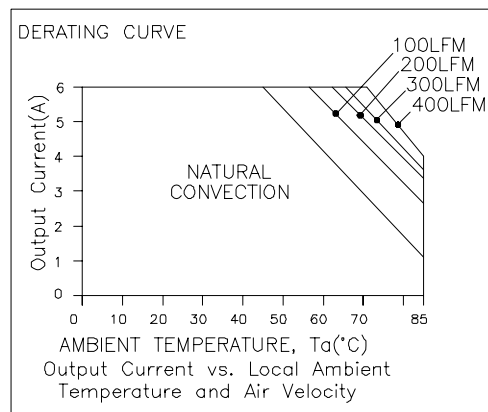

$V_{in}=12\text{ V}, V_o=5.0\text{ V}$

**NON-ISOLATED DC/DC CONVERTERS**  
 8.3 Vdc - 14 Vdc Input      0.75 Vdc - 5.5 Vdc/6 A Output



**Ripple and Noise Waveforms**

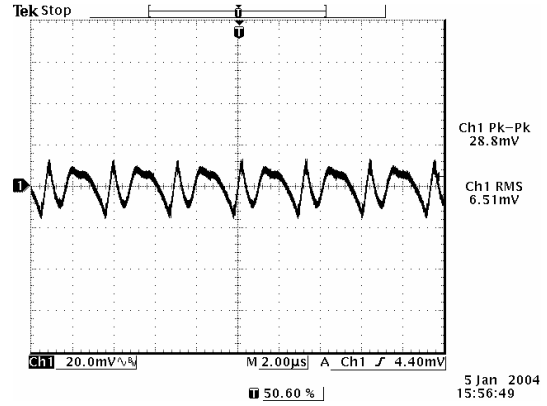
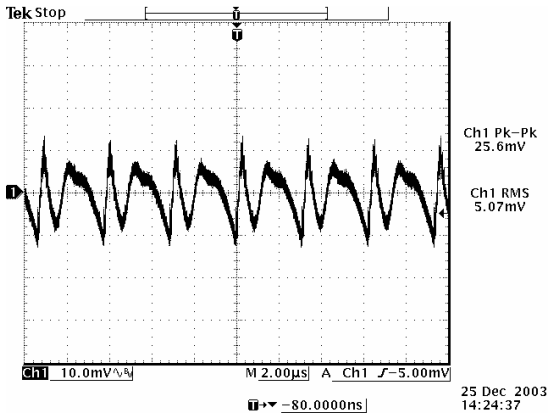

Ripple and noise at full load,  $V_{in}=12\text{ V}$ ,  $V_o=0.75\text{ V}$

Ripple and noise at full load,  $V_{in}=12\text{ V}$ ,  $V_o=1.2\text{ V}$

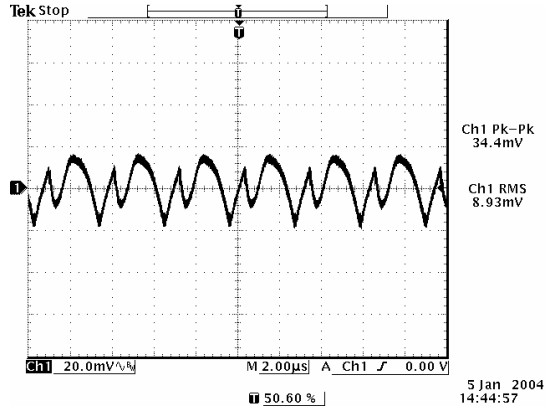
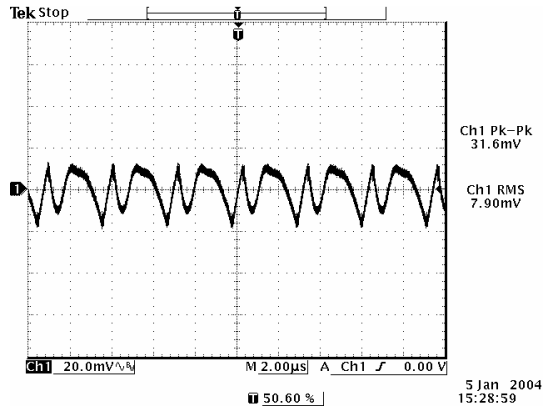

Ripple and noise at full load,  $V_{in}=12\text{ V}$ ,  $V_o=1.8\text{ V}$

Ripple and noise at full load,  $V_{in}=12\text{ V}$ ,  $V_o=2.5\text{ V}$

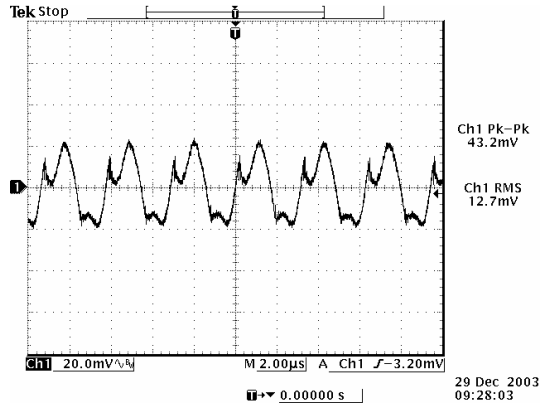
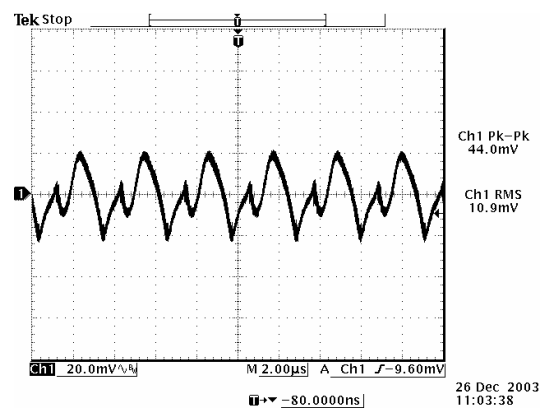

Ripple and noise at full load,  $V_{in}=12\text{ V}$ ,  $V_o=3.3\text{ V}$

Ripple and noise at full load,  $V_{in}=12\text{ V}$ ,  $V_o=5.0\text{ V}$

**Note:** The output ripple and noise is tested at 0-20 MHz BW, 10  $\mu\text{F}/10\text{ V}$  tantalum capacitor and 1  $\mu\text{F}/10\text{ V}$  ceramic capacitor,  $T_a=25\text{ deg C}$ .

# NON-ISOLATED DC/DC CONVERTERS

8.3 Vdc - 14 Vdc Input      0.75 Vdc - 5.5 Vdc/6 A Output



## Transient Response Waveforms

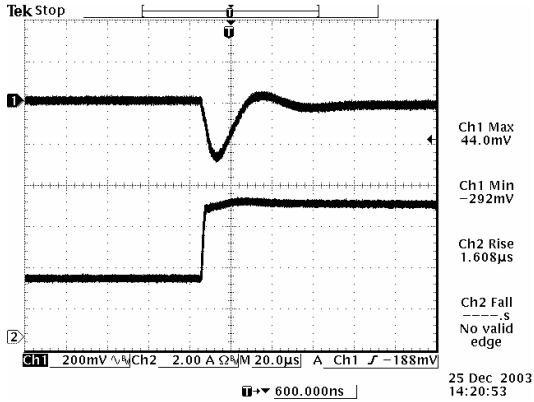

50% to 100% load step at  $V_{in}=12\text{ V}$ ,  $V_o=0.75\text{ V}$

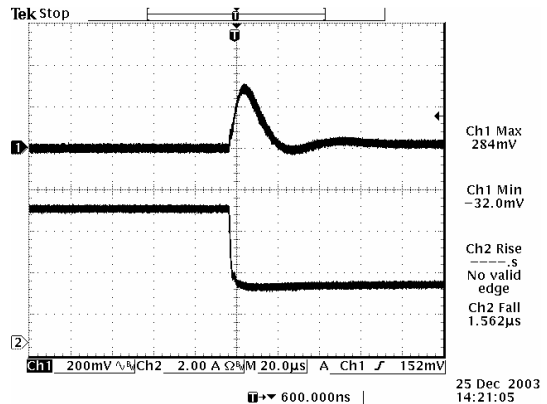

100% to 50% load step at  $V_{in}=12\text{ V}$ ,  $V_o=0.75\text{ V}$

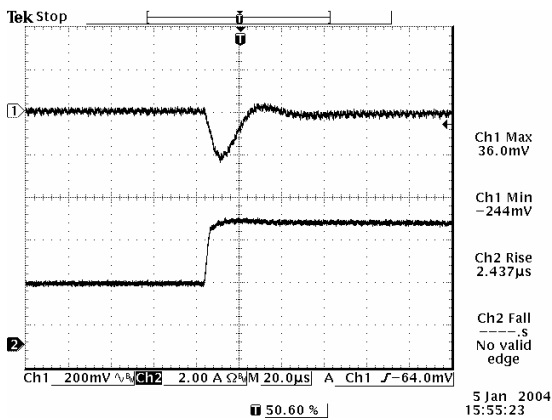

50% to 100% load step at  $V_{in}=12\text{ V}$ ,  $V_o=1.2\text{ V}$

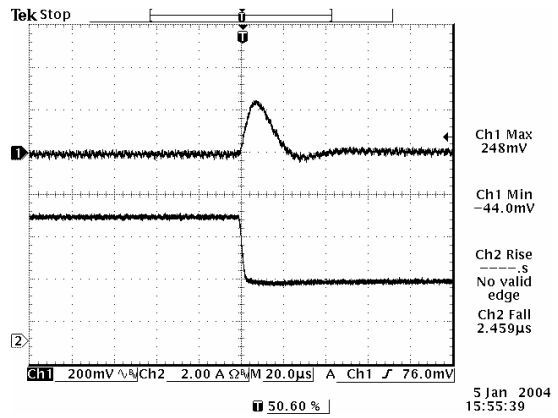

100% to 50% load step at  $V_{in}=12\text{ V}$ ,  $V_o=1.2\text{ V}$

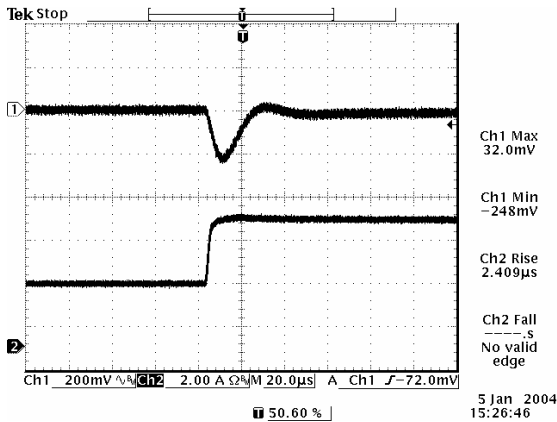

50% to 100% load step at  $V_{in}=12\text{ V}$ ,  $V_o=1.8\text{ V}$

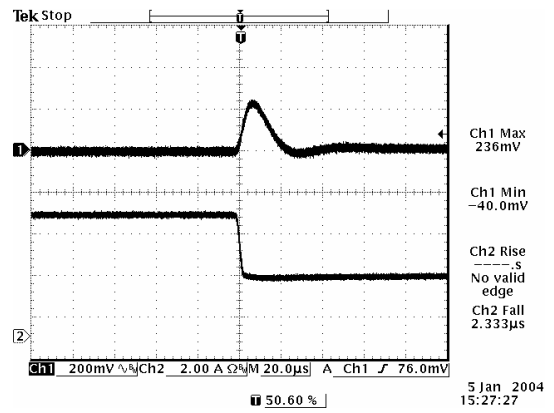

100% to 50% load step at  $V_{in}=12\text{ V}$ ,  $V_o=1.8\text{ V}$



# NON-ISOLATED DC/DC CONVERTERS

8.3 Vdc - 14 Vdc Input      0.75 Vdc - 5.5 Vdc/6 A Output



## Transient Response Waveforms (continued)

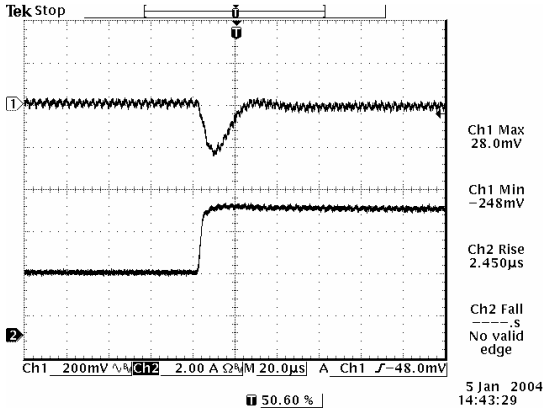

50% to 100% load step at  $V_{in}=12\text{ V}$ ,  $V_o=2.5\text{ V}$

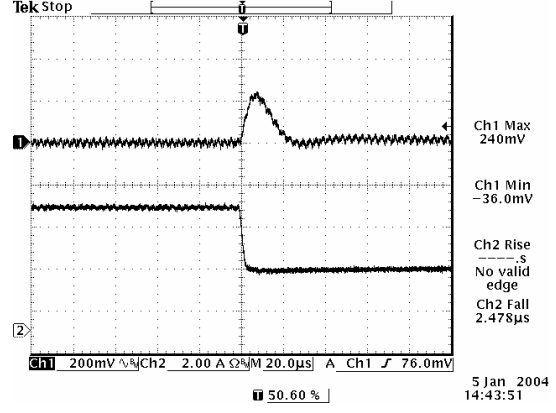

100% to 50% load step at  $V_{in}=12\text{ V}$ ,  $V_o=2.5\text{ V}$

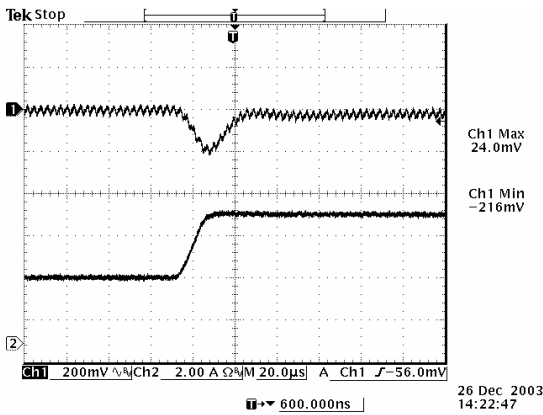

50% to 100% load step at  $V_{in}=12\text{ V}$ ,  $V_o=3.3\text{ V}$

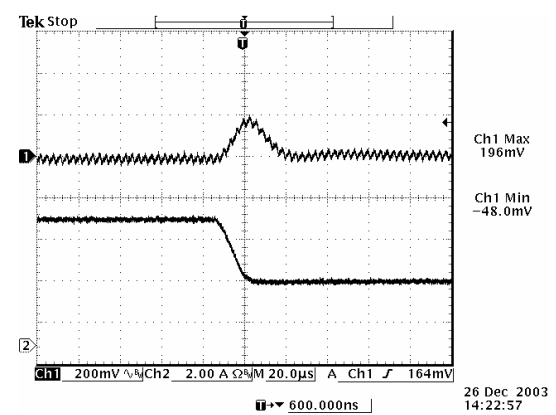

100% to 50% load step at  $V_{in}=12\text{ V}$ ,  $V_o=3.3\text{ V}$

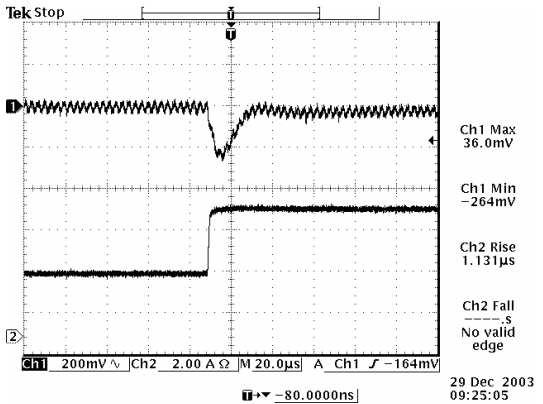

50% to 100% load step at  $V_{in}=12\text{ V}$ ,  $V_o=5.0\text{ V}$

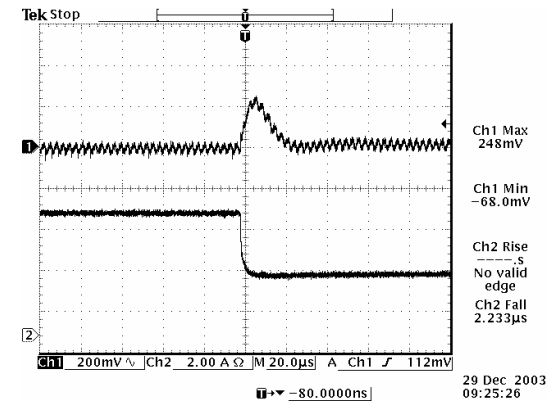

100% to 50% load step at  $V_{in}=12\text{ V}$ ,  $V_o=5.0\text{ V}$

**Note:** Transient response is tested at  $di/dt=2.5\text{ A/uS}$ , with 10 uF/10 V tantalum capacitor and 1 uF/10 V ceramic capacitor,  $T_a=25\text{ deg C}$ .

**NON-ISOLATED DC/DC CONVERTERS**  
 8.3 Vdc - 14 Vdc Input      0.75 Vdc - 5.5 Vdc/6 A Output



**Mechanical Outline**

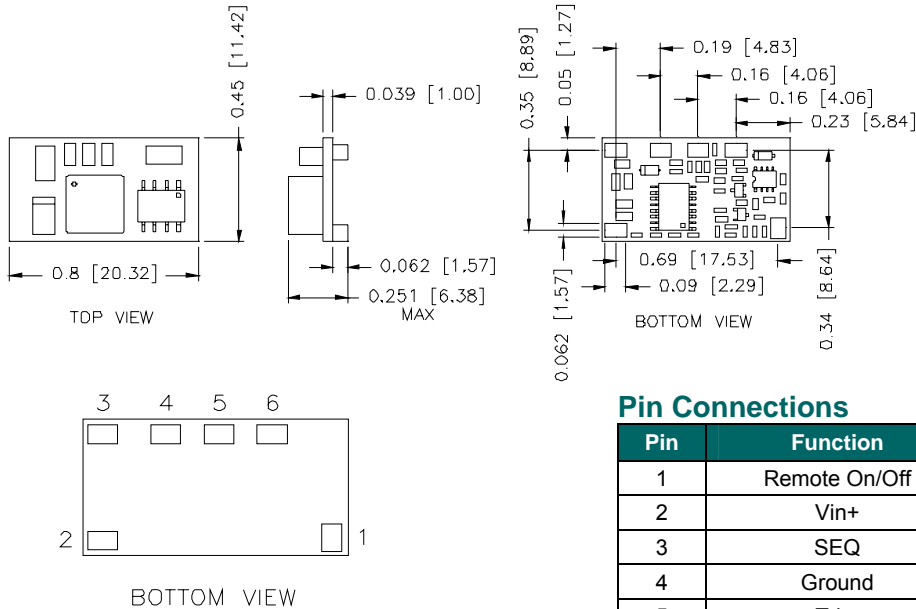

**Pin Connections**

Pin	Function
1	Remote On/Off
2	Vin+
3	SEQ
4	Ground
5	Trim
6	Vout+

**RECOMMENDED PAD LAYOUT**

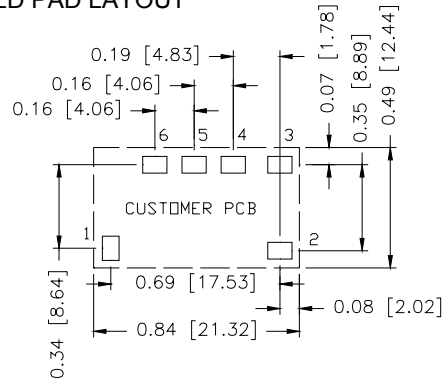

**PAD SIZE:**  
 MIN: 0.12" \* 0.095" (3.05mm \* 2.41mm)  
 MAX: 0.135" \* 0.11" (3.43mm \* 2.79mm)

**RoHS Compliance**

Complies with the European Directive 2002/95/EC, calling for the elimination of lead and other hazardous substances from electronic products.



©2007 Bel Fuse Inc. Specifications subject to change without notice. 011207

**CORPORATE**

**Bel Fuse Inc.**  
 206 Van Vorst Street  
 Jersey City, NJ 07302  
 Tel 201-432-0463  
 Fax 201-432-9542  
[www.belfuse.com](http://www.belfuse.com)

**FAR EAST**

**Bel Fuse Ltd.**  
 8F/ 8 Luk Hop Street  
 San Po Kong  
 Kowloon, Hong Kong  
 Tel 852-2328-5515  
 Fax 852-2352-3706  
[www.belfuse.com](http://www.belfuse.com)

**EUROPE**

**Bel Fuse Europe Ltd.**  
 Preston Technology Management Centre  
 Marsh Lane, Suite G7, Preston  
 Lancashire, PR1 8UD, U.K.  
 Tel 44-1772-556601  
 Fax 44-1772-888366  
[www.belfuse.com](http://www.belfuse.com)