

## NON-ISOLATED DC/DC CONVERTERS

4.5 Vdc -14 Vdc Input 0.75 Vdc - 5.0 Vdc/6 A Output

**bel**  
POWER PRODUCTS

### xRBA-06E2Ax Series RoHS Compliant Rev.A

- Non-Isolated
- High Efficiency
- High Power Density
- Fixed Frequency
- Flexible Output Voltage Sequencing
- Under-voltage Lockout (UVLO)
- Remote On/Off
- OCP/SCP
- Wide Input
- Wide Trim Range

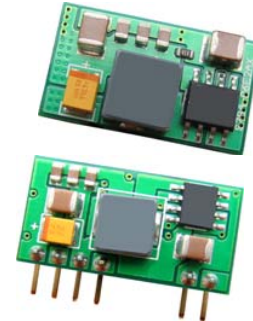

### Description

The Bel xRBA-06E2Ax modules are a series of non-isolated dc/dc converters that can deliver up to 6 A of output current with full load efficiency of 92% at 5.0 Vdc output. These modules provide precisely regulated voltage programmable via external resistor from 0.75 Vdc to 5.0 Vdc over a wide range of input voltage. These modules have a sequencing feature that enables designers to implement various types of output voltage sequencing when powering multiple voltages on a board. Their open-frame construction and small footprint enable designers to develop cost and space-efficient solutions. Standard features include remote On/Off, programmable output voltage and over current protection.

### Part Selection

Output Voltage	Input Voltage	Max. Output Current	Max. Output Power	Typical Efficiency	Model Number Surface Mount	Model Number Vertical Mount
5.0 V	7.0 V - 14 V	6 A	30.0 W	92%	SRBA-06E2Ax	VRBA-06E2Ax
0.75 V - 3.3 V <sup>1</sup>	4.5 V - 14 V	6 A	19.8 W	88%	SRBA-06E2Ax	VRBA-06E2Ax

- Notes:**
1. These modules use a buck topology, so the output voltages must be 0.5 V less than the input voltage.
  2. Use "0" to replace "x" for remote on/off active high logic and use "L" for active low logic. Add "G" suffix at the end of the model numbers to indicate Tray Packaging.
  3. All part numbers above indicate RoHS 6. Change the second letter "R" to "7" for RoHS 5 part numbers.

### Absolute Maximum Ratings

Parameter	Min	Typ	Max	Notes
Input Voltage (continuous)	-0.3 V	-	15 V	
Output Enable Terminal Voltage	-0.3 V	-	15 V	
Sequencing Voltage <sup>1</sup>	-0.3 V	-	V <sub>in</sub>	
Ambient Temperature	-40 °C	-	85 °C	
Storage Temperature	-55 °C	-	125 °C	

**Notes:** All specifications are typical at 25 °C unless otherwise stated.

1. xRBA-06E2Ax series of modules include a sequencing feature that enables users to implement various types of output voltage sequencing in their applications. This is accomplished via an additional sequencing pin. When the sequencing feature is not used, tie the SEQ pin to V<sub>in</sub>.

## NON-ISOLATED DC/DC CONVERTERS

4.5 Vdc -14 Vdc Input 0.75 Vdc - 5.0 Vdc/6 A Output



### Input Specifications

Parameter	Min	Typ	Max	Notes
Input Voltage				
Vo, set ≤ 3.3 V	4.5 V	12 V	14 V	
Vo, set = 5.0 V	7.0 V	12 V	14 V	
Input Current (full load)				
Vo = 5.0 V	-	2.75 A	4.8 A	
Vo = 3.3 V	-	1.85 A	4.8 A	
Vo = 1.8 V	-	1.05 A	3.2 A	
Vo = 0.75 V	-	0.55 A	1.8 A	
Input Current (no load)				
Vo = 5.0 V	-	-	100 mA	
Vo = 0.75 V	-	-	20 mA	
Remote Off Input Current	-	3 mA	5 mA	
Input Reflected Ripple Current (pk-pk)	-	120 mA	200 mA	With simulated source impedance of 1 uH, 5 Hz to 20 MHz and two 100 uF/25 V external input tantalum capacitors.
Input Reflected Ripple Current (rms)	-	60 mA	100 mA	
I <sup>2</sup> t Inrush Current Transient	-	0.002 A <sup>2</sup> s	0.02 A <sup>2</sup> s	
Turn-on Voltage Threshold				
Vo, set ≤ 3.3 V	-	4.3 V	4.5 V	
Vo, set = 5.0 V	-	6.0 V	6.5 V	
Turn-off Voltage Threshold				Shut down or below 90% set point.
Vo, set ≤ 3.3 V	-	4.0 V	4.3 V	
Vo, set = 5.0 V	-	5.5 V	6.0 V	

### Output Specifications

Parameter	Min	Typ	Max	Notes	
Output Voltage Set Point	-2%Vo,set	-	2%Vo,set	Vin=12 V, full load	
Output Voltage Set Point <sup>1</sup>	-2.5%Vo,set	-	3.5%Vo,set		
Load Regulation	-0.7%Vo,set	0.4%Vo,set	0.7%Vo,set	Io=Io, min to Io, max	
Line Regulation	-0.7%Vo,set	0.3%Vo,set	0.7%Vo,set	Vin=Vin, min to Vin, max	
Regulation Over Temperature (-40 °C to +85 °C)	-	0.5%Vo,set	-	Tref=Ta, min to Ta, max	
Output Current	0 A	-	6 A		
Current Limit Threshold	6.8 A	-	15 A		
Short Circuit Surge Transient	-	0.25 A <sup>2</sup> s	-		
Ripple and Noise (pk-pk)				Tested with 0-20 MHz, with 10 uF/10 V tantalum capacitor & 1 uF/10 V ceramic capacitor at the output	
Vo = 5.0 V	-	100 mV	140 mV		
Vo = 3.3 V	-	80 mV	120 mV		
Ripple and Noise (rms)				Tested with 0-20 MHz, with 10 uF/10 V tantalum capacitor & 1 uF/10 V ceramic capacitor at the output	
Vo = 5.0 V	-	35 mV	50 mV		
Vo = 3.3 V	-	25 mV	40 mV		
Vo = 0.75 V	-	10 mV	15 mV		
Turn on Time	-	6 mS	12 mS		
Overshoot at Turn on	-	0%	3%		
Output Capacitance					
ESR ≥ 1mohm	0 uF	-	1000 uF		
ESR ≥ 10mohm	0 uF	-	2200 uF		
<b>Transient Response</b>					
50% ~ 100% Max Load	All outputs	-	200 mV	350 mV	di/dt=2.5 A/uS; Vin=12 V; and with 10 uF/10 V tantalum capacitor & 1uF/10 V ceramic capacitor at the output.
Settling Time		-	25 uS	50 uS	
100% ~ 50% Max Load		-	200 mV	350 mV	
Settling Time		-	25 uS	50 uS	

**Notes:** All specifications are typical at nominal input (Vin=12 V), full load at 25 °C unless otherwise stated.

1. Over all operating input voltages, resistive loads and temperature conditions.

## NON-ISOLATED DC/DC CONVERTERS

4.5 Vdc -14 Vdc Input 0.75 Vdc - 5.0 Vdc/6 A Output



### General Specifications

Parameter	Min	Typ	Max	Notes
Efficiency				Measured at Vin=12 V, full load
Vo=5.0 V	88%	92%	-	
Vo=3.3 V	85%	88%	-	
Vo=1.8 V	80%	84%	-	
Vo=0.75 V	68%	73%	-	
Switching Frequency	220 kHz	250 kHz	280 kHz	
Output Voltage Trim Range (wide trim)	0.7525 V	-	5 V	
MTBF	3,079,469 hours			Calculated Per Bell Core SR-332 (Vin=12 V; Vo=3.3 V, Io=4.8 V; Ta = 25 °C)
Dimensions				Surface Mount
Inches (L x W x H) Millimeters (L x W x H)	0.8 x 0.45 x 0.251 20.32 x 11.42 x 6.38			
Dimensions				Vertical Mount
Inches (L x W x H) Millimeters (L x W x H)	1.0 x 0.5 x 0.243 25.4 x 12.7 x 6.16			
Weight	-	5 g	-	

**Note:** All specifications are typical at 25 °C unless otherwise stated.

### Control Specifications

Parameter	Min	Typ	Max	Notes
<b>Remote On/Off</b>				
Signal Low (Unit Off)	-0.3 V	-	0.4 V	xRBA-06E2A0; Remote On/Off pin open, Unit on.
Signal High (Unit On)	2.5 V	-	14 V	
Signal Low (Unit On)	-0.3 V	-	0.4 V	xRBA-06E2AL; Remote On/Off pin open, Unit on.
Signal High (Unit Off)	2.5 V	-	14 V	
<b>Voltage Sequencing</b>				
Sequencing Voltage	0.05 V	-	Vin	Sequencing Voltage should be higher than output voltage.
Sequencing Slew Rate Capability	-	-	2 V/mS	
Sequencing Delay Time	10 mS	-	-	Delay from Vin, min to application of voltage on SEQ pin
Tracking Accuracy				
Power-Up	-	100 mV	200 mV	
Power-Down	-	200 mV	400 mV	

### Output Trim Equations

Equation for calculating the trim resistor (in kΩ) given the desired adjusted voltage (Vadj) is shown below. The Trim Up resistor should be connected between the Trim pin and Ground.

$$R_{trim} = \frac{10.507}{V_{adj} - 0.7525} - 1$$

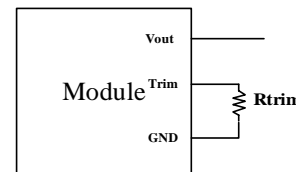

Equation for calculating the trim voltage (in V) given the desired adjusted voltage (Vadj) is shown below. The Trim Up voltage should be connected between the Trim pin and Ground.

$$V_{trim} = 0.7 - 0.0667 \times (V_{adj} - 0.7525)$$

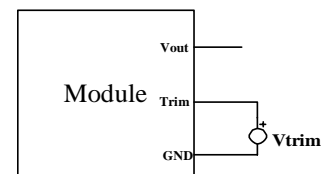

# NON-ISOLATED DC/DC CONVERTERS

4.5 Vdc -14 Vdc Input    0.75 Vdc - 5.0 Vdc/6 A Output



## Efficiency Data

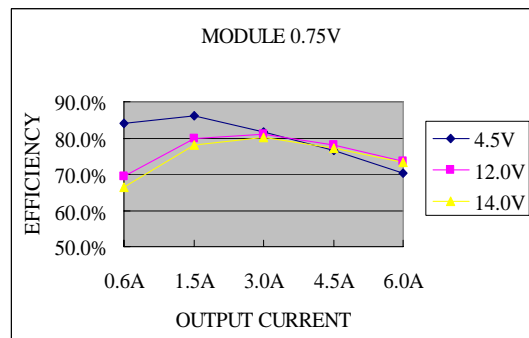
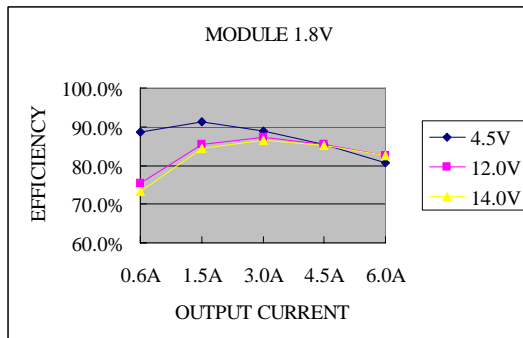
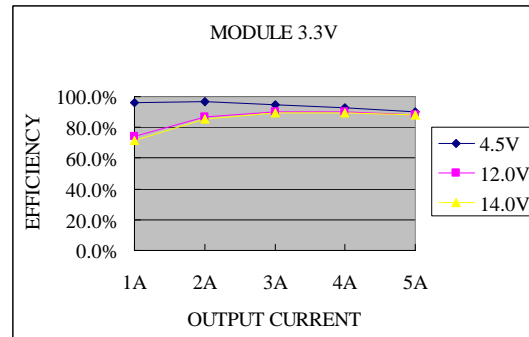
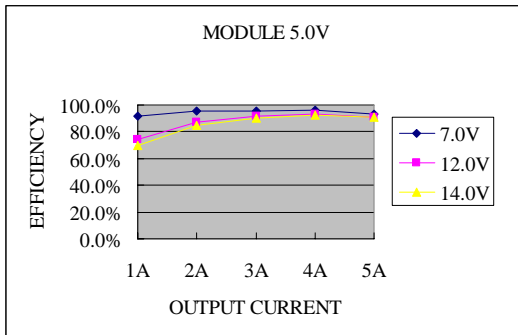

# NON-ISOLATED DC/DC CONVERTERS

4.5 Vdc -14 Vdc Input    0.75 Vdc - 5.0 Vdc/6 A Output



## Thermal Derating Curves

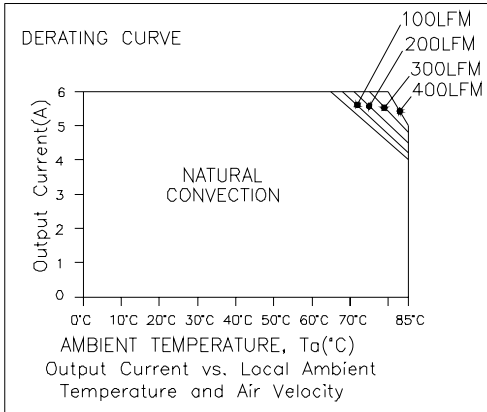

SRBA-06E2Ax,  $V_o=0.75\text{ V}$

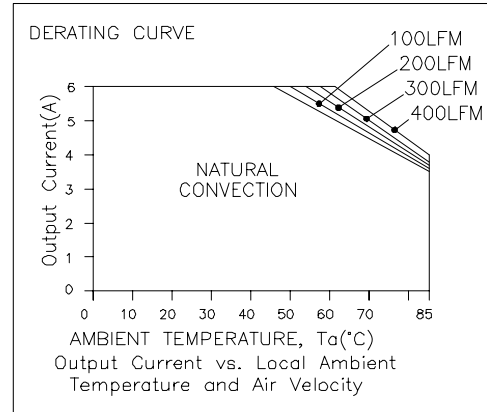

VRBA-06E2Ax,  $V_o=0.75\text{ V}$

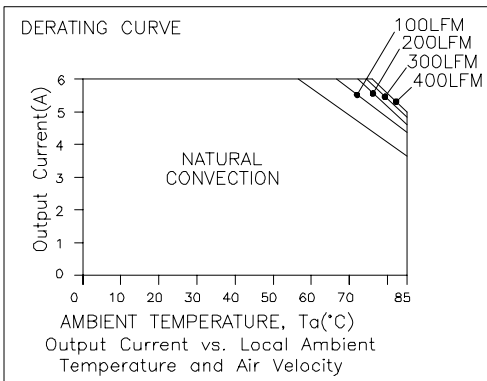

SRBA-06E2Ax,  $V_o=2.5\text{ V}$

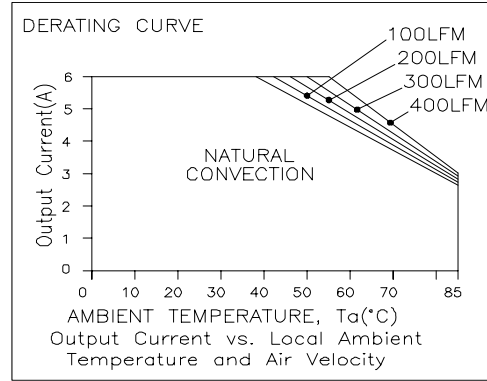

VRBA-06E2Ax,  $V_o=2.5\text{ V}$

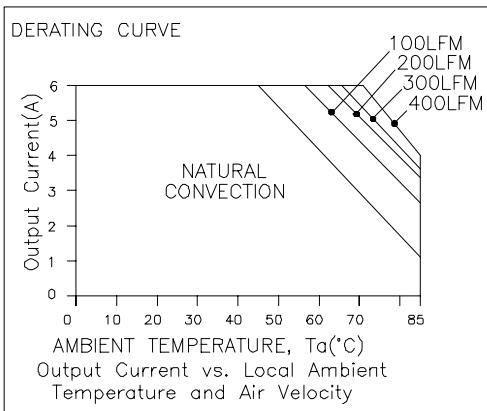

SRBA-06E2Ax,  $V_o=5.0\text{ V}$

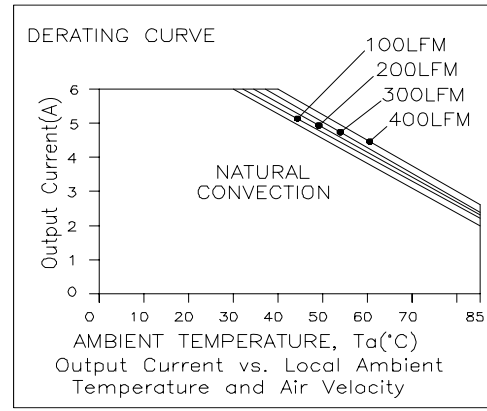

VRBA-06E2Ax,  $V_o=5.0\text{ V}$

# NON-ISOLATED DC/DC CONVERTERS

4.5 Vdc -14 Vdc Input    0.75 Vdc - 5.0 Vdc/6 A Output



## Ripple and Noise Waveforms

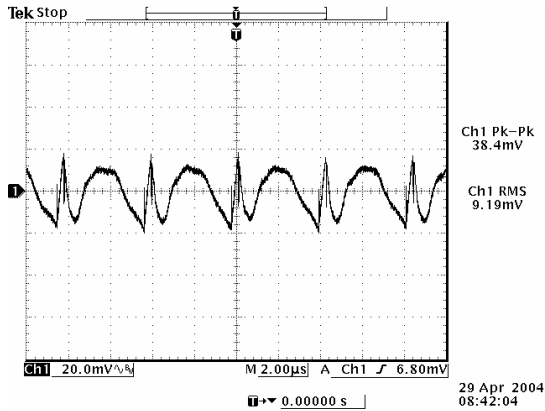

Ripple and noise at full load,  $V_o=0.75$  V

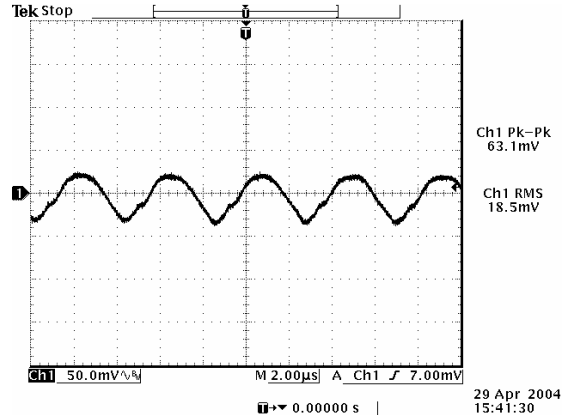

Ripple and noise at full load,  $V_o=1.8$  V

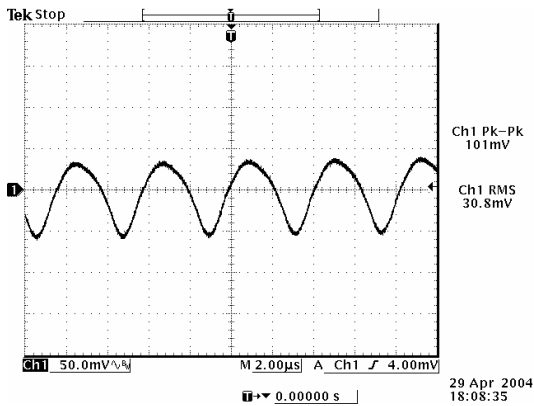

Ripple and noise at full load,  $V_o=3.3$  V

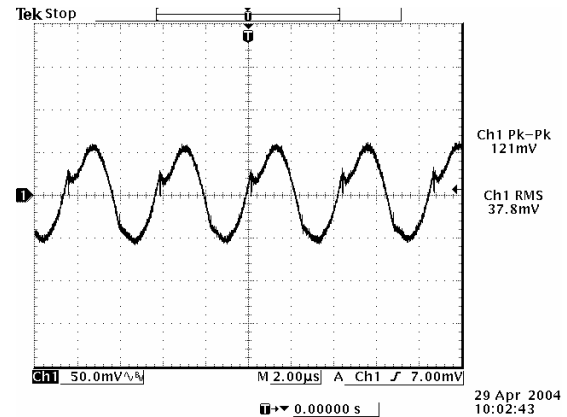

Ripple and noise at full load,  $V_o=5.0$  V

**Note:** Ripple and noise at 12 V input, 0-20 MHz BW, 10  $\mu$ F/10 V tantalum capacitor and 1  $\mu$ F/10 V ceramic capacitor,  $T_a=25$  deg C.

# NON-ISOLATED DC/DC CONVERTERS

4.5 Vdc -14 Vdc Input    0.75 Vdc - 5.0 Vdc/6 A Output



## Transient Response Waveforms

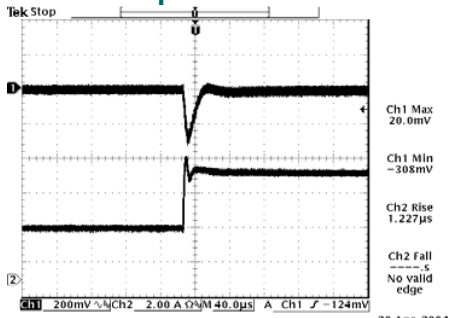

50% to 100% load step at 0.75 V output

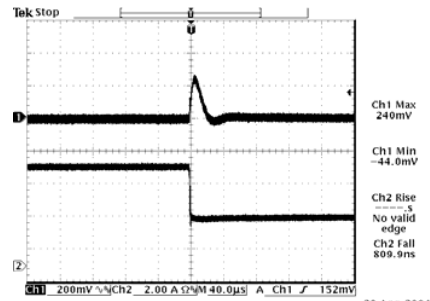

100% to 50% load step at 0.75 V output

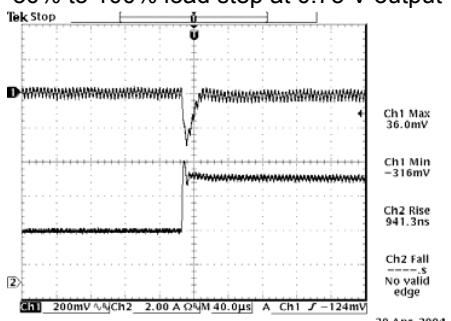

50% to 100% load step at 1.8 V output

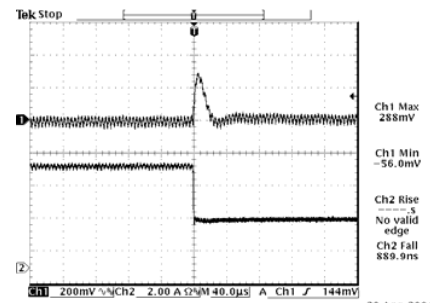

100% to 50% load step at 1.8 V output

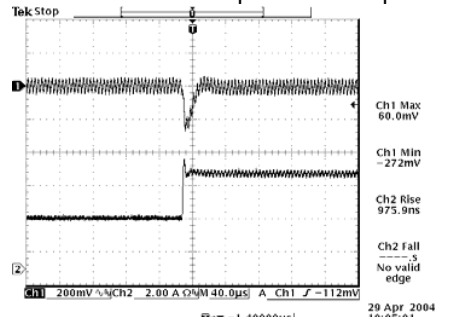

50% to 100% load step at 3.3 V output

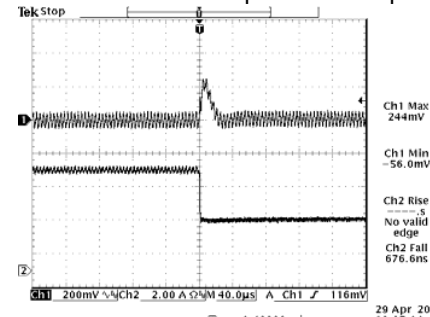

100% to 50% load step at 3.3 V output

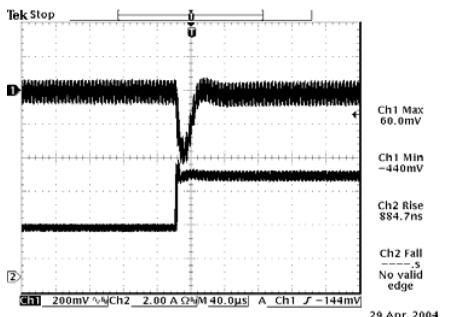

50% to 100% load step at 5.0 V output

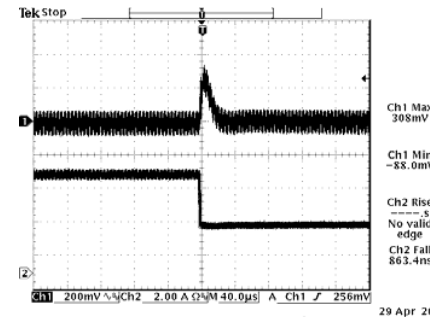

100% to 50% load step at 5.0 V output

**Note:** Transient response at 12 V input, di/dt=2.5 A/uS, with 10 uF/10 V tantalum capacitor and 1uF/10 V ceramic capacitor, and Ta=25 deg C.

**NON-ISOLATED DC/DC CONVERTERS**  
 4.5 Vdc -14 Vdc Input    0.75 Vdc - 5.0 Vdc/6 A Output



**Mechanical Outline**

**SRBA-06E2Ax**

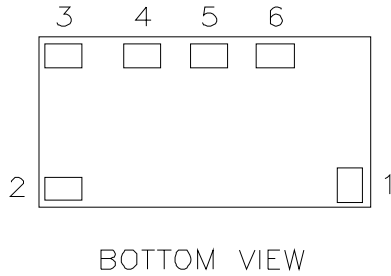
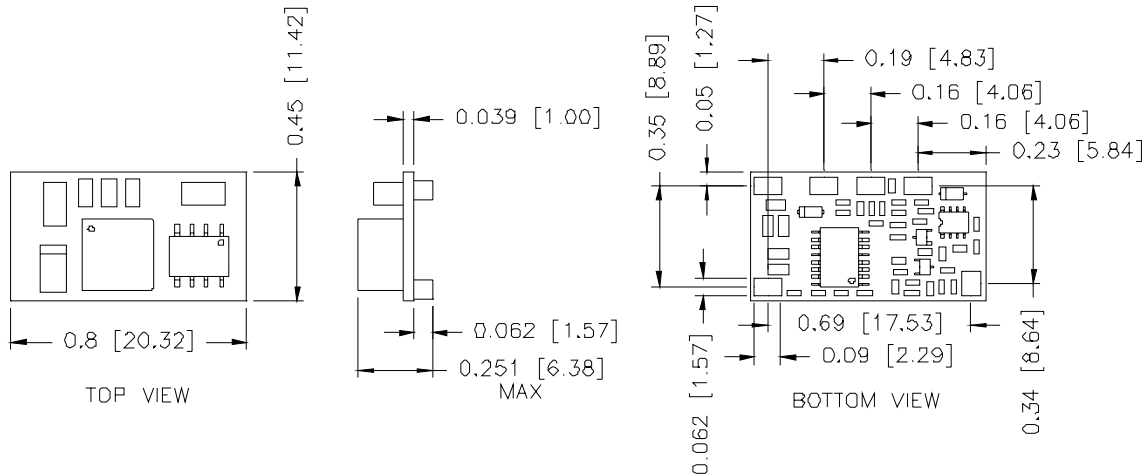

**Pin Connections**

Pin	Function
1	Remote On/Off
2	Vin+
3	SEQ
4	Ground
5	Trim
6	Vout+

**RECOMMENDED PAD LAYOUT**

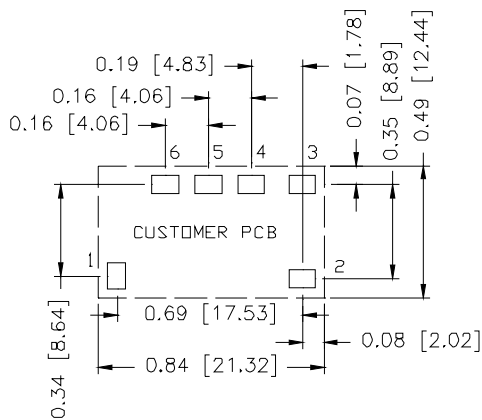

**PAD SIZE:**  
 MIN: 0.12" \* 0.095" (3.05mm \* 2.41mm)  
 MAX: 0.135" \* 0.11" (3.43mm \* 2.79mm)



# NON-ISOLATED DC/DC CONVERTERS

4.5 Vdc -14 Vdc Input    0.75 Vdc - 5.0 Vdc/6 A Output



## Mechanical Outline (continued)

### VRBA-06E2Ax

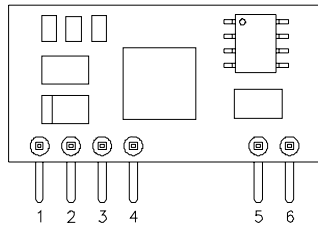
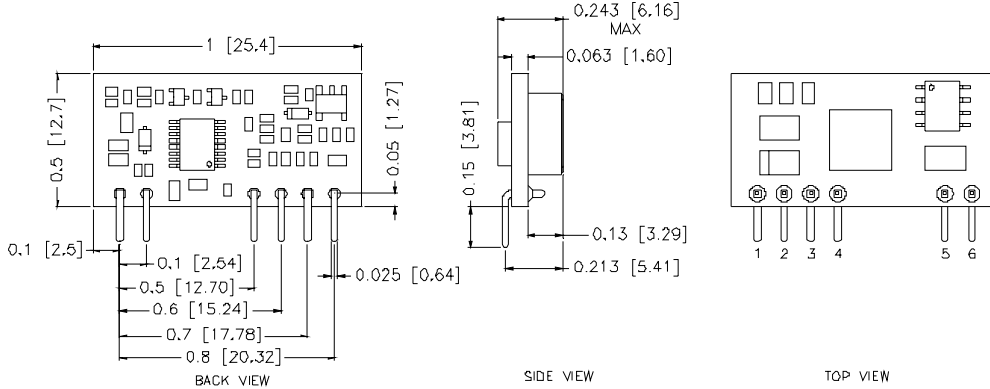

## Pin Connections

Pin	Function
1	Vout+
2	Trim
3	Ground
4	SEQ
5	Vin+
6	Remote On/Off

Recommended Pad Layout for SIP Module

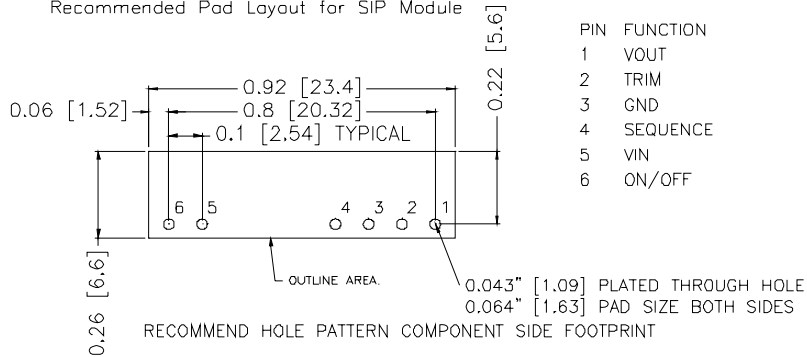

## RoHS Compliance

Complies with the European Directive 2002/95/EC, calling for the elimination of lead and other hazardous substances from electronic products.



©2007 Bel Fuse Inc. Specifications subject to change without notice. 011207

### CORPORATE

**Bel Fuse Inc.**  
 206 Van Vorst Street  
 Jersey City, NJ 07302  
 Tel 201-432-0463  
 Fax 201-432-9542  
[www.belfuse.com](http://www.belfuse.com)

### FAR EAST

**Bel Fuse Ltd.**  
 8F/ 8 Luk Hop Street  
 San Po Kong  
 Kowloon, Hong Kong  
 Tel 852-2328-5515  
 Fax 852-2352-3706  
[www.belfuse.com](http://www.belfuse.com)

### EUROPE

**Bel Fuse Europe Ltd.**  
 Preston Technology Management Centre  
 Marsh Lane, Suite G7, Preston  
 Lancashire, PR1 8UD, U.K.  
 Tel 44-1772-556601  
 Fax 44-1772-888366  
[www.belfuse.com](http://www.belfuse.com)