

PTH12010 12 Vin Single Output

Total Power: 66W
of Outputs: Single

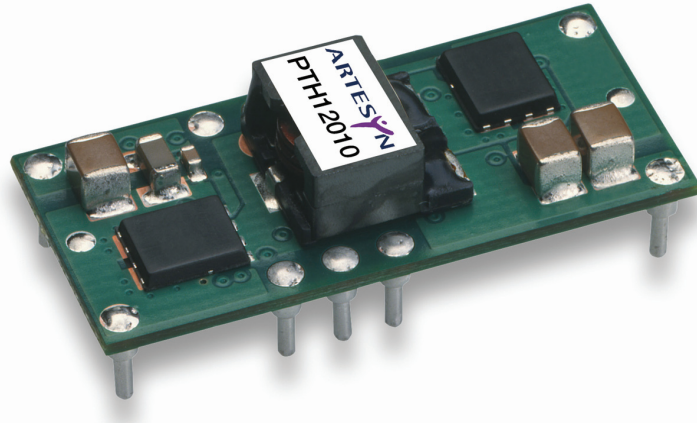

Special Features

- 12 A output current
- 12 V input voltage
- Wide-output voltage adjust
 - 1.2 Vdc to 5.5 Vdc for suffix 'W' and 0.8 Vdc to 1.8 Vdc for suffix 'L'
- Auto-track™ sequencing*
- Margin up/down controls
- Efficiencies up to 94%
- Output ON/OFF inhibit
- Output voltage sense
- Point-of-Load-Alliance (POLA) compatible
- Available RoHS compliant
- 2 Year Warranty

Safety

- UL/cUL CAN/CSA-C22.2 No. 60950-1-03/UL 60950-1, File No. E174104
- TÜV Product Service (EN60950) Certificate No. B 04 06 38572 044
- CB Report and Certificate to IEC60950, Certificate No. US/8292/UL

Specifications

Input		
Input voltage range:	(See Note 3)	10.8 - 13.2 Vdc
Input current:	No load	10 mA typ.
Remote ON/OFF:	(See Note 1)	Positive logic
Start-up time:		1 V/ms
Undervoltage lockout:		9.0 - 9.5 V typ.
Track input voltage:	Pin 8 (See Note 6)	± 0.3 Vin
Output		
Voltage adjustability: (See Note 4)	Suffix '-W' Suffix '-L'	1.2 - 5.5 Vdc 0.8 - 1.8 Vdc
Setpoint accuracy:		± 2.0% Vo
Line regulation:		± 10 mV typ.
Load regulation:		± 12 mV typ.
Total regulation:		± 3.0% Vo
Minimum load:		0 A
Ripple and noise:	20 MHz bandwidth	25 mV pk-pk
Temperature co-efficient:	-40 °C to +85 °C	± 0.5% Vo
Transient response: (See Note 5)		70 μs recovery time Overshoot/undershoot 100 mV
Margin adjustment:		± 5.0% Vo

All specifications are typical at nominal input, full load at 25 °C unless otherwise stated
Cin = 560 μF, Cout = 0 μF

*Auto-track™ is a trade mark of
Texas Instruments



EMC Characteristics	
Electrostatic discharge:	EN61000-4-2, IEC801-2
Conducted immunity:	EN61000-4-6
Radiated immunity:	EN61000-4-3

General Specifications		
Efficiency:		See tables on page 3
Insulation voltage:		Non-Isolated
Switching frequency:	Suffix '-W' Suffix '-L'	300 kHz to 400 kHz 200 kHz to 300 kHz
Approvals and standards:		EN60950, UL/cUL60950
Material flammability:		UL94V-0
Dimensions:	(L x W x H)	34.80 x 15.75 x 9.00 mm 1.370 x 0.620 x 0.354 in
Weight:		5g (0.18 oz)
MTBF	Telcordia SR-332	7,092,000 hours

Environmental Specifications

Thermal performance:	Operating ambient, temperature Non-operating	-40° C to +85 °C -40° C to +125 °C
MSL ('Z' suffix only)	JEDEC J-STD-020C	Level 3

Protection		
Short circuit:	Auto reset	20 A typ.

Ordering Information

Output Power (max)	Input Voltage	Output Voltage	Output Currents		Efficiency (max)	Regulation		Model Numbers ^(8,9)
			Min	Max		Line	Load	
66 W	10.8 - 13.2 Vdc	0.8 - 1.8 Vdc	0 A	12 A	89%	±10 mV	±12 mV	PTH12010L
66 W	10.8 - 13.2 Vdc	1.2 - 5.5 Vdc	0 A	12 A	94%	±10 mV	±12 mV	PTH12010W

Part Number System with Options

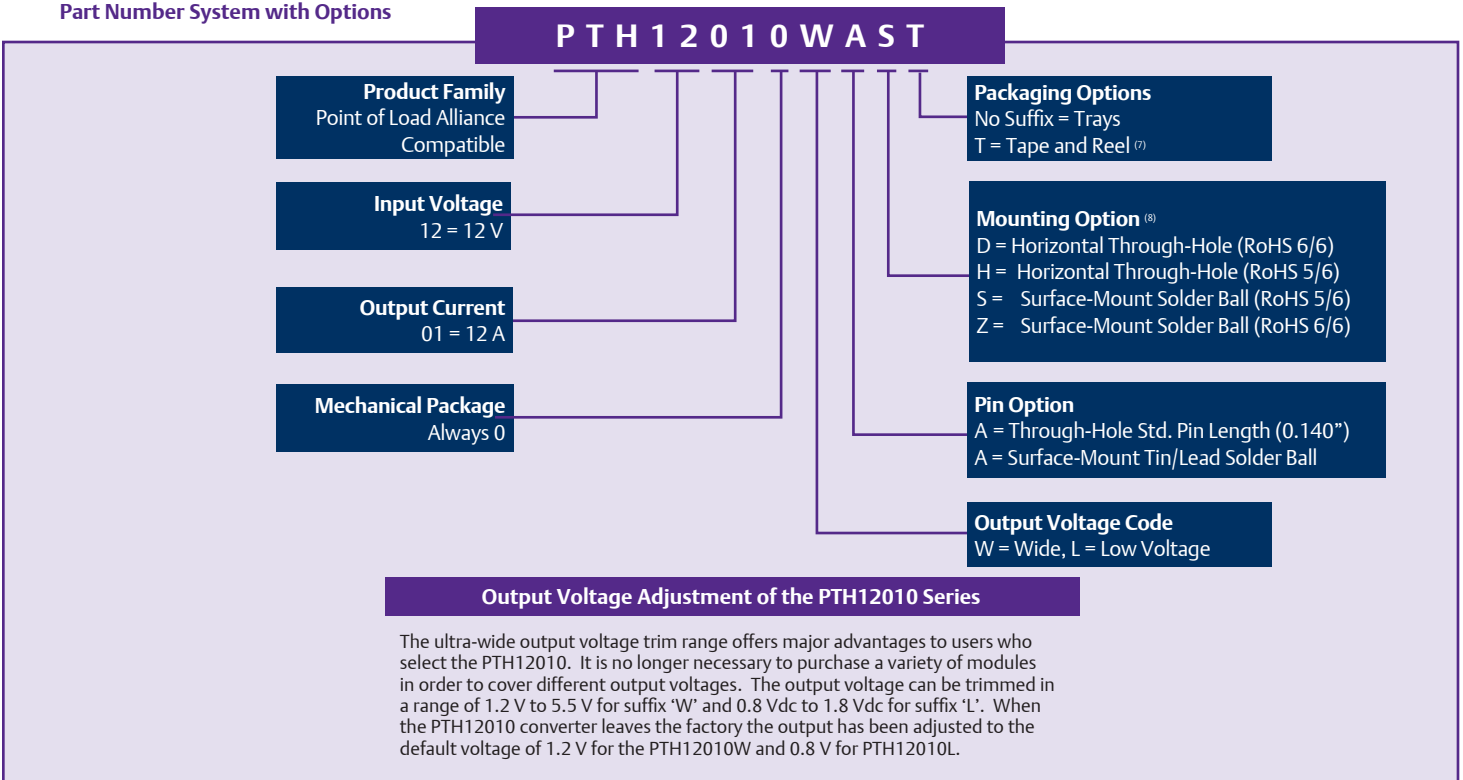

Efficiency Table - PTH12010W ($I_O = 8\text{ A}$)

Output Voltage	Efficiency
$V_o = 5.0\text{ V}$	94%
$V_o = 3.3\text{ V}$	93%
$V_o = 2.5\text{ V}$	91%
$V_o = 2.0\text{ V}$	90%
$V_o = 1.8\text{ V}$	89%
$V_o = 1.5\text{ V}$	88%
$V_o = 1.2\text{ V}$	86%

Efficiency Table - PTH12010L ($I_O = 8\text{ A}$)

Output Voltage	Efficiency
$V_o = 1.8\text{ V}$	89%
$V_o = 1.5\text{ V}$	88%
$V_o = 1.2\text{ V}$	86%
$V_o = 1.0\text{ V}$	84%
$V_o = 0.8\text{ V}$	82%

Notes

- Remote ON/OFF. Positive Logic
ON: Pin 3 open; or $V > V_{in} - 0.5\text{ V}$
OFF: Pin 3 GND; or $V < 0.8\text{ V}$ (min - 0.2 V).
- See Figures 1, 2 and 3 for safe operating curves for the PTH12010W and Figures 6 and 7 for PTH12010L.
- A 560 μF electrolytic input capacitor is required for proper operation. The capacitor must be rated for a minimum of 800 mA rms of ripple current.
- An external output capacitor is not required for basic operation. Adding 330 μF of distributed capacitance at the load will improve the transient response.
- 1 A/ μs load step, 50 to 100% I_{Omax} , $C_{out} = 330\text{ }\mu\text{F}$.
- If utilized V_{out} will track applied voltage by $\pm 0.3\text{ V}$ (up to V_o set point).
- Tape and reel packaging only available on the surface-mount versions.
- To order Pb-free (RoHS compatible) surface-mount parts replace the mounting option 'S' with 'Z', e.g. PTH12010WAZ. To order Pb-free (RoHS compatible) through-hole parts replace the mounting option 'H' with 'D', e.g. PTH12010WAD.
- NOTICE: Some models do not support all options. Please contact your local Emerson Network power representative or use the on-line model number search tool at <http://www.PowerConversion.com> to find a suitable alternative.

PTH12010W Characteristic Data

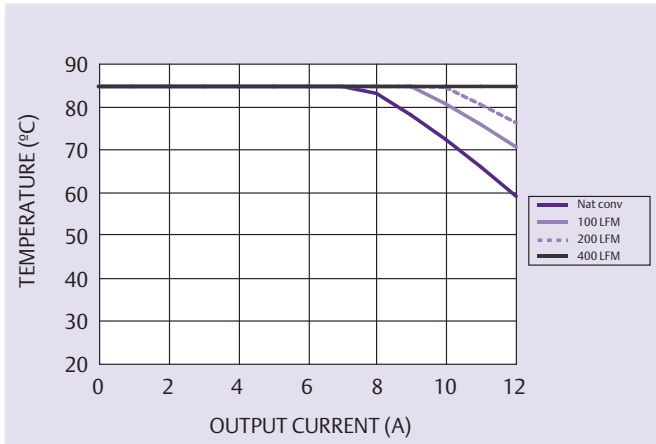

Figure 1 - Safe Operating Area
Vin = 12 V, Output Voltage = 5 V (See Note A)

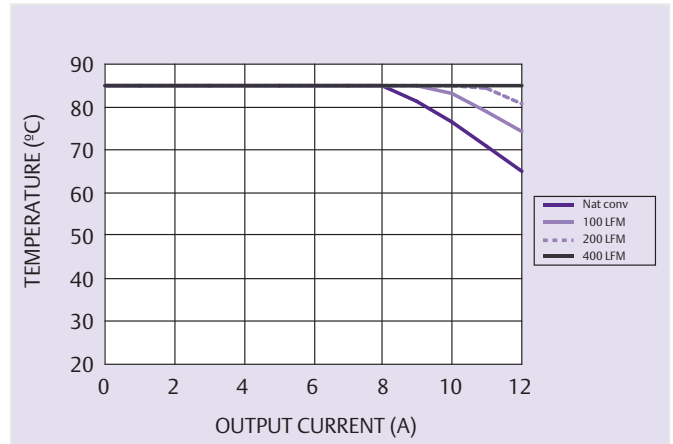

Figure 2 - Safe Operating Area
Vin = 12 V, Output Voltage = 3.3 V (See Note A)

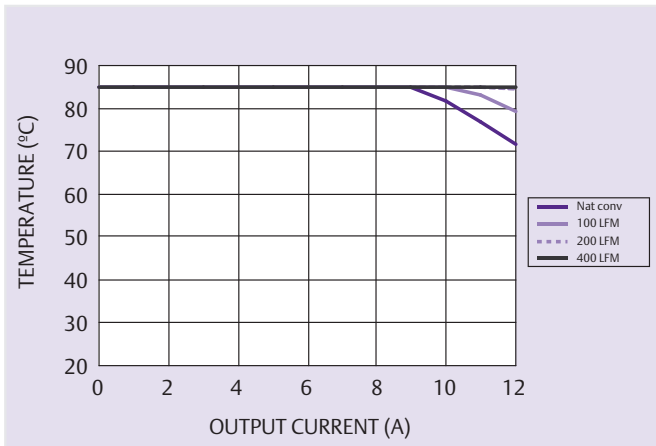

Figure 3 - Safe Operating Area
Vin = 12 V, Output Voltage ≤ 1.8 V (See Note A)

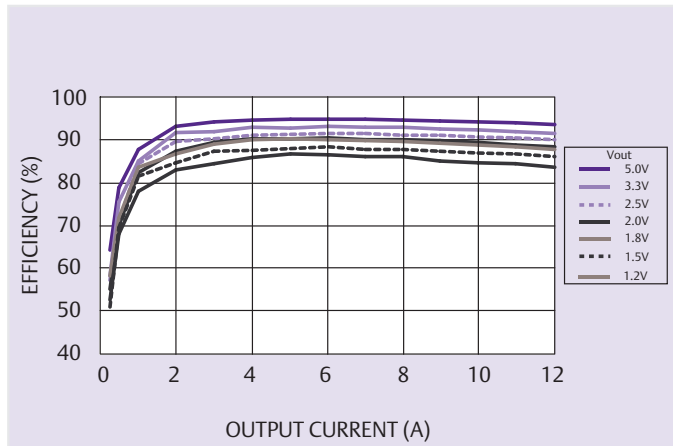

Figure 4 - Efficiency vs Load Current
Vin = 12 V (See Note B)

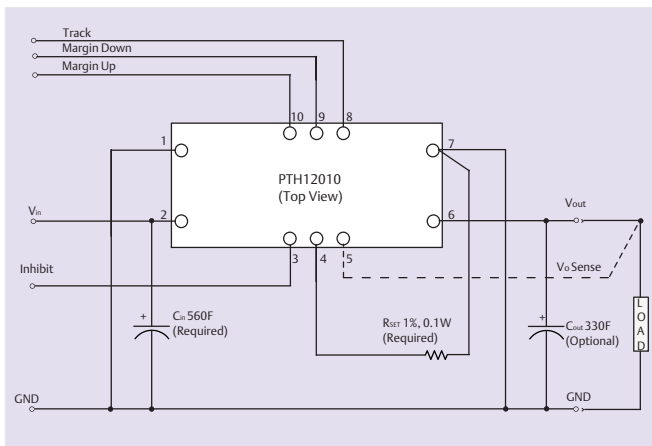

Figure 5 - Standard Application

Notes

- A SOA curves represent the conditions at which internal components are within the Emerson Network Power derating guidelines.
- B Characteristic data has been developed from actual products tested at 25 °C. This data is considered typical data for the converter.

PTH12010L Characteristic Data

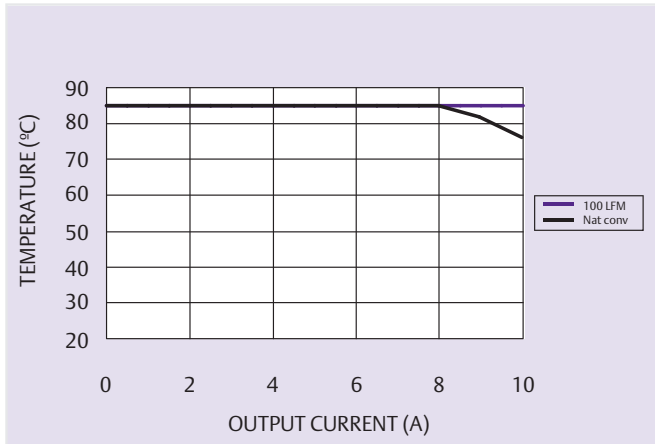

Figure 6 - Safe Operating Area
 $V_{in} = 12\text{ V}$, Output Voltage $\leq 1.8\text{ V}$ (See Note A)

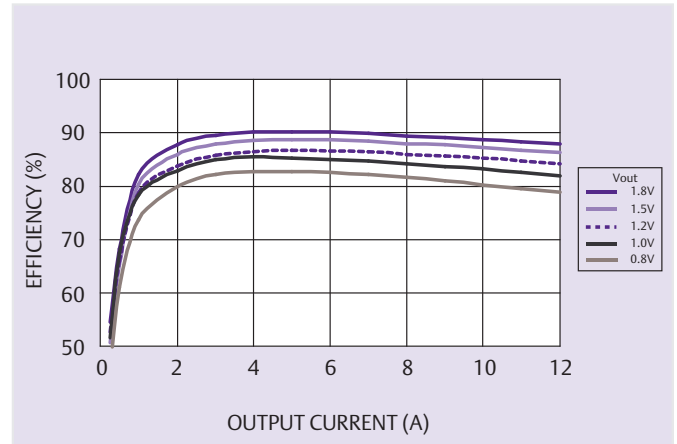

Figure 7 - Efficiency vs Load Current
 $V_{in} = 12\text{ V}$ (See Note B)

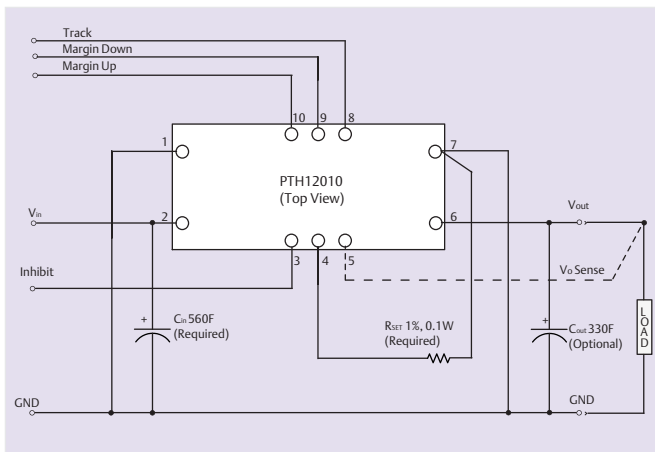

Figure 8 - Standard Application

Notes

- A SOA curves represent the conditions at which internal components are within the Emerson Network Power derating guidelines.
- B Characteristic data has been developed from actual products tested at 25 °C. This data is considered typical data for the converter.

Mechanical Drawings

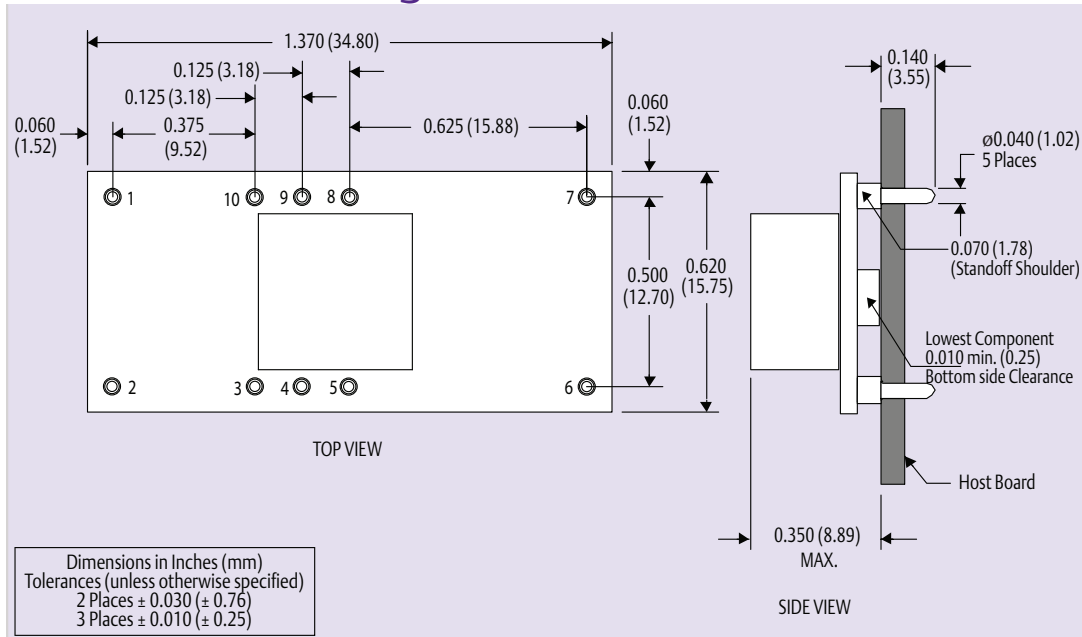

Figure 9 - Plated Through-Hole

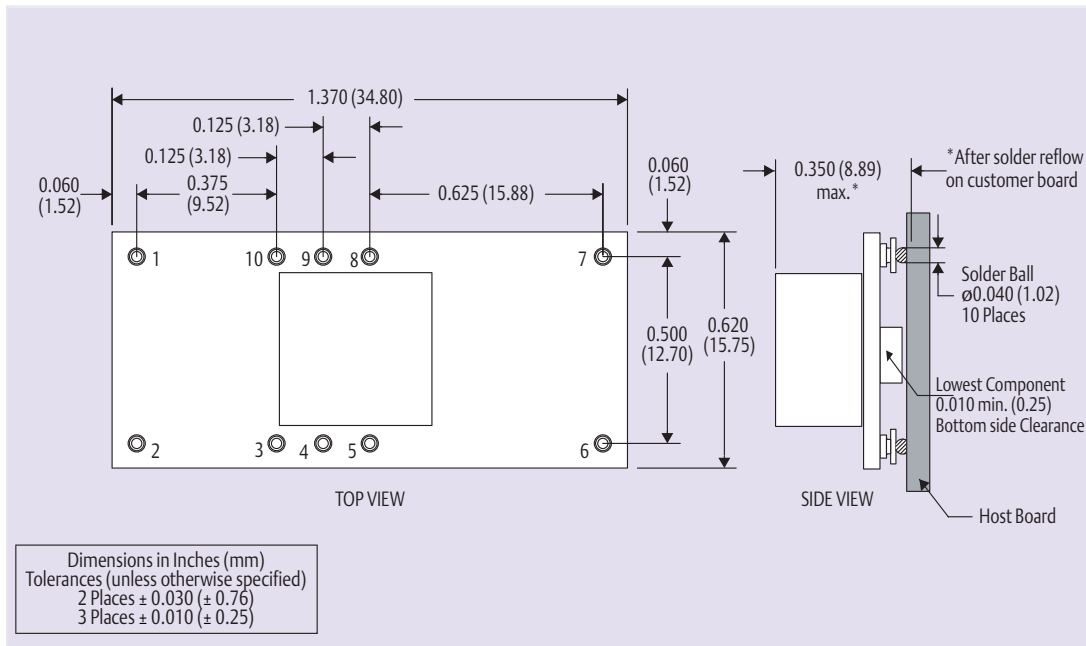

Figure 10 - Surface-Mount

Pin Connections		Pin Connections cont.	
Pin No.	Function	Pin No.	Function
Pin 1	Ground	Pin 6	Vout
Pin 2	Vin	Pin 7	Ground
Pin 3	Inhibit*	Pin 8	Track
Pin 4	Vo adjust	Pin 9	Margin down*
Pin 5	Vo sense	Pin 10	Margin up*

* Denotes negative logic:
Open = Normal operation
Ground = Function active

Americas

5810 Van Allen Way
Carlsbad, CA 92008
USA
Telephone: +1 760 930 4600
Facsimile: +1 760 930 0698

Europe (UK)

Waterfront Business Park
Merry Hill, Dudley
West Midlands, DY5 1LX
United Kingdom
Telephone: +44 (0) 1384 842 211
Facsimile: +44 (0) 1384 843 355

Asia (HK)

14/F, Lu Plaza
2 Wing Yip Street
Kwun Tong, Kowloon
Hong Kong
Telephone: +852 2176 3333
Facsimile: +852 2176 3888

For global contact, visit:

www.PowerConversion.com
techsupport.embeddedpower@emerson.com

While every precaution has been taken to ensure accuracy and completeness in this literature, Emerson Network Power assumes no responsibility, and disclaims all liability for damages resulting from use of this information or for any errors or omissions.

Emerson Network Power.
The global leader in enabling business-critical continuity.

- AC Power
- Connectivity
- DC Power
- Embedded Computing
- Embedded Power
- Monitoring
- Outside Plant
- Power Switching & Controls
- Precision Cooling
- Racks & Integrated Cabinets
- Services
- Surge Protection

EmersonNetworkPower.com

Emerson Network Power and the Emerson Network Power logo are trademarks and service marks of Emerson Electric Co. ©2008 Emerson Electric Co.