

DELPHI SERIES

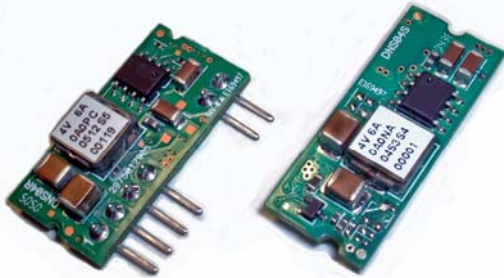

FEATURES

- ♦ High efficiency: 89.5%@ 12Vin, 3.3V/6A out
- ♦ Small size and low profile: (SIP)
25.4x 12.7x 6.67mm (1.00" x 0.50" x 0.26")
- ♦ Standard footprint
- ♦ Voltage and resistor-based trim
- ♦ Pre-bias startup
- ♦ Output Voltage tracking
- ♦ No minimum load required
- ♦ Output voltage programmable from 0.75Vdc to 5Vdc via external resistor
- ♦ Fixed frequency operation (350KHz)
- ♦ Input UVLO, output OTP, OCP
- ♦ Remote ON/OFF
- ♦ ISO 9001, TL 9000, ISO 14001, QS 9000, OHSAS 18001 certified manufacturing facility
- ♦ UL/cUL 60950-1 (US & Canada) Recognized, and TUV (EN60950-1) certified.
- ♦ CE mark meets 73/23/EEC and 93/68/EEC directives

Delphi DNS, Non-Isolated Point of Load DC/DC Power Modules: 8.3~14Vin, 0.75~5.0V/6A out

The Delphi series DNS, 8.3~14V input, single output, non-isolated point of load DC/DC converters are the latest offering from a world leader in power systems technology and manufacturing — Delta Electronics, Inc. The DNS series provides a programmable output voltage from 0.75V to 5.0V through an external trimming resistor. The DNS converters have flexible and programmable tracking and sequencing features to enable a variety of sequencing and tracking between several point of load power modules. This product family is available in a surface mount or SIP package and provides up to 6A of output current in an industry standard footprint and pinout. With creative design technology and optimization of component placement, these converters possess outstanding electrical and thermal performance and extremely high reliability under highly stressful operating conditions.

OPTIONS

- ♦ Negative on/off logic
- ♦ Tracking feature
- ♦ SIP package

APPLICATIONS

- ♦ Telecom / DataCom
- ♦ Distributed power architectures
- ♦ Servers and workstations
- ♦ LAN / WAN applications
- ♦ Data processing applications

DATASHEET
DS_DNS10SIP06_03092009

Delta Electronics, Inc.

TECHNICAL SPECIFICATIONS

($T_A = 25^\circ\text{C}$, airflow rate = 300 LFM, $V_{in} = 8.3\text{Vdc}$ and 14Vdc , nominal V_{out} unless otherwise noted.)

PARAMETER	NOTES and CONDITIONS	DNS10S0A0R06NFD			
		Min.	Typ.	Max.	Units
ABSOLUTE MAXIMUM RATINGS					
Input Voltage (Continuous)		0		15	Vdc
Tracking Voltage		0		$V_{in,max}$	Vdc
Operating Temperature	Refer to Figure 30 for measuring point	-40		+120	$^\circ\text{C}$
Storage Temperature		-55		+125	$^\circ\text{C}$
INPUT CHARACTERISTICS					
Operating Input Voltage	$V_{o,set} \leq 3.63\text{Vdc}$	8.3	12	14	V
	$V_{o,set} > 3.63\text{Vdc}$	8.3	12	13.2	V
Input Under-Voltage Lockout					
Turn-On Voltage Threshold			7.9		V
Turn-Off Voltage Threshold			7.8		V
Maximum Input Current	$V_{in} = V_{in,min}$ to $V_{in,max}$, $I_o = I_o,max$			4.5	A
No-Load Input Current			100		mA
Off Converter Input Current			2		mA
Inrush Transient	$V_{in} = V_{in,min}$ to $V_{in,max}$, $I_o = I_o,min$ to I_o,max			0.4	A 2 S
Recommended Input Fuse				6	A
OUTPUT CHARACTERISTICS					
Output Voltage Set Point	$V_{in} = 12\text{V}$, $I_o = I_o,max$	-2.0	$V_{o,set}$	+2.0	% $V_{o,set}$
Output Voltage Adjustable Range		0.7525		5	V
Output Voltage Regulation					
Over Line	$V_{in} = V_{in,min}$ to $V_{in,max}$		0.3		% $V_{o,set}$
Over Load	$I_o = I_o,min$ to I_o,max		0.4		% $V_{o,set}$
Over Temperature	$T_a = -40^\circ\text{C}$ to 85°C		0.4		% $V_{o,set}$
Total Output Voltage Range	Over sample load, line and temperature	-2.5		+3.5	% $V_{o,set}$
Output Voltage Ripple and Noise	5Hz to 20MHz bandwidth				
Peak-to-Peak	$V_{in} = \text{min to max}$, $I_o = \text{min to max}$ $1\mu\text{F}$ ceramic, $10\mu\text{F}$ Tan		50	75	mV
RMS	$V_{in} = \text{min to max}$, $I_o = \text{min to max}$ $1\mu\text{F}$ ceramic, $10\mu\text{F}$ Tan		15	30	mV
Output Current Range		0		6	A
Output Voltage Over-shoot at Start-up	$V_{out} = 3.3\text{V}$			1	% $V_{o,set}$
Output DC Current-Limit Inception			200		% I_o
Output Short-Circuit Current (Hiccup mode)	$I_o,s/c$		2		Adc
DYNAMIC CHARACTERISTICS					
Dynamic Load Response	$10\mu\text{F}$ Tan & $1\mu\text{F}$ ceramic load cap, $2.5\text{A}/\mu\text{s}$, $V_{in} = 12\text{V}$				
Positive Step Change in Output Current	50% I_o , max to 100% I_o , max		200		mVpk
Negative Step Change in Output Current	100% I_o , max to 50% I_o , max		200		mVpk
Settling Time ($V_o < 10\%$ Peak Deviation)			25		μs
Turn-On Transient	$I_o = I_o,max$				
Start-Up Time, From On/Off Control	$V_{on/off}$, $V_o = 10\%$ of $V_{o,set}$		3		ms
Start-Up Time, From Input	$V_{in} = V_{in,min}$, $V_o = 10\%$ of $V_{o,set}$		3		ms
Output Voltage Rise Time	Time for V_o to rise from 10% to 90% of $V_{o,set}$		4	6	ms
Output Capacitive Load	Full load; ESR $\geq 1\text{m}\Omega$			1000	μF
	Full load; ESR $\geq 10\text{m}\Omega$			3000	μF
EFFICIENCY					
$V_o = 0.75\text{V}$	$V_{in} = 12\text{V}$, $I_o = I_o,max$		72.5		%
$V_o = 1.2\text{V}$	$V_{in} = 12\text{V}$, $I_o = I_o,max$		80.0		%
$V_o = 1.5\text{V}$	$V_{in} = 12\text{V}$, $I_o = I_o,max$		83.0		%
$V_o = 1.8\text{V}$	$V_{in} = 12\text{V}$, $I_o = I_o,max$		85.0		%
$V_o = 2.5\text{V}$	$V_{in} = 12\text{V}$, $I_o = I_o,max$		87.5		%
$V_o = 3.3\text{V}$	$V_{in} = 12\text{V}$, $I_o = I_o,max$		89.5		%
$V_o = 5.0\text{V}$	$V_{in} = 12\text{V}$, $I_o = I_o,max$		91.5		%
FEATURE CHARACTERISTICS					
Switching Frequency			350		kHz
ON/OFF Control, (Negative logic)					
Logic Low Voltage	Module On, $V_{on/off}$	-0.2		0.3	V
Logic High Voltage	Module Off, $V_{on/off}$	2.5		$V_{in,max}$	V
Logic Low Current	Module On, $I_{on/off}$			10	μA
Logic High Current	Module Off, $I_{on/off}$		0.2	1	mA
ON/OFF Control, (Positive Logic)					
Logic High Voltage	Module On, $V_{on/off}$			$V_{in,max}$	V
Logic Low Voltage	Module Off, $V_{on/off}$	-0.2		0.3	V
Logic High Current	Module On, $I_{on/off}$			10	μA
Logic Low Current	Module Off, $I_{on/off}$		0.2	1	mA
Tracking Slew Rate Capability		0.1		2	V/msec
Tracking Delay Time	Delay from $V_{in,min}$ to application of tracking voltage	10			ms
Tracking Accuracy	Power-up, subject to $2\text{V}/\text{mS}$		100	200	mV
	Power-down, subject to $1\text{V}/\text{mS}$		200	400	mV
GENERAL SPECIFICATIONS					
MTBF	$I_o = 80\% I_o,max$, $T_a = 25^\circ\text{C}$		2.12		M hours
Weight			4		grams
Over-Temperature Shutdown	Refer to Figure 30 for the measuring point		124		$^\circ\text{C}$

ELECTRICAL CHARACTERISTICS CURVES

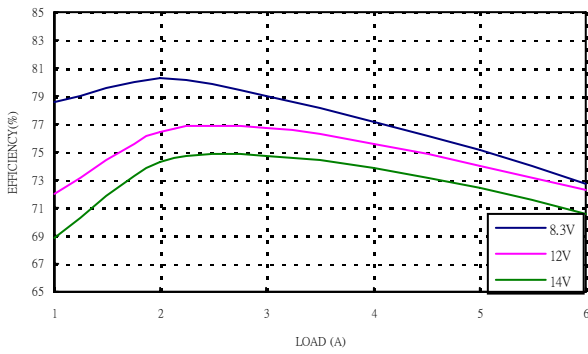

Figure 1: Converter efficiency vs. output current (0.75V output voltage)

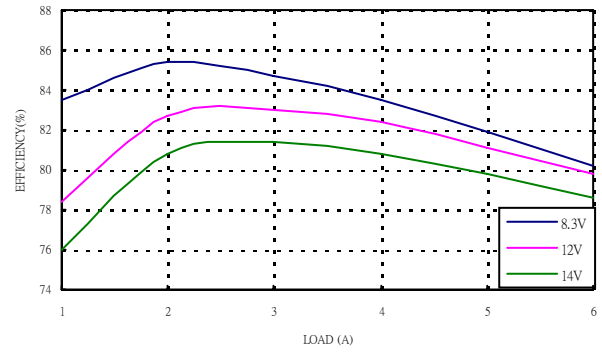

Figure 2: Converter efficiency vs. output current (1.2V output voltage)

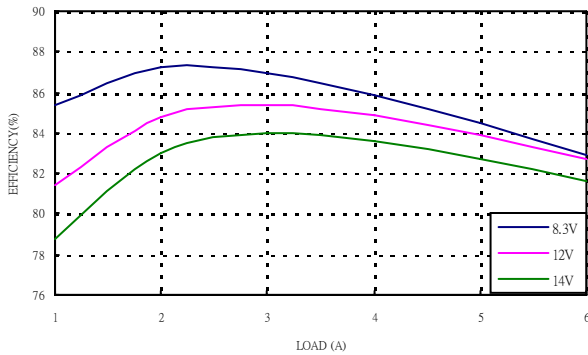

Figure 3: Converter efficiency vs. output current (1.5V output voltage)

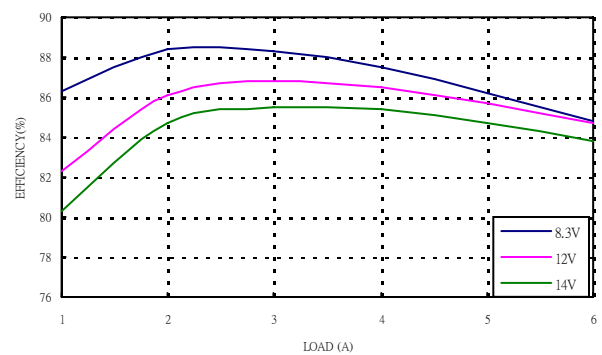

Figure 4: Converter efficiency vs. output current (1.8V output voltage)

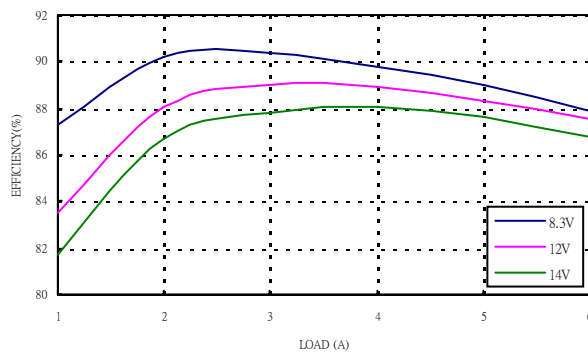

Figure 5: Converter efficiency vs. output current (2.5V output voltage)

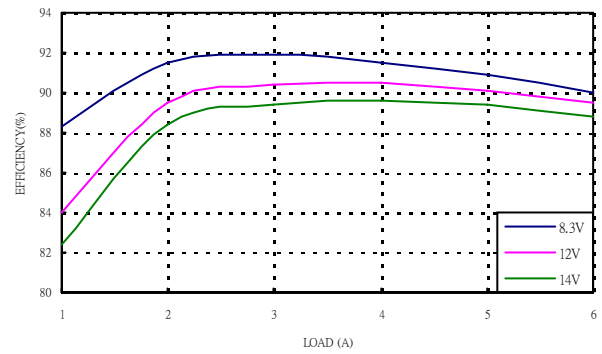

Figure 6: Converter efficiency vs. output current (3.3V output voltage)



ELECTRICAL CHARACTERISTICS CURVES

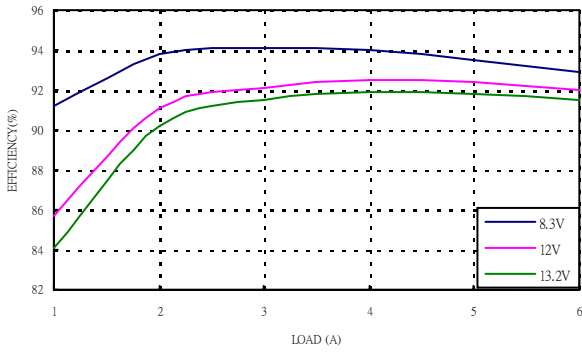

Figure 7: Converter efficiency vs. output current (5.0V output voltage)

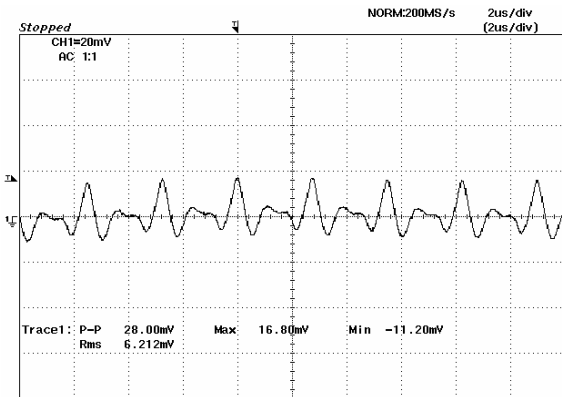

Figure 8: Output ripple & noise at 12Vin, 2.5V/6A out

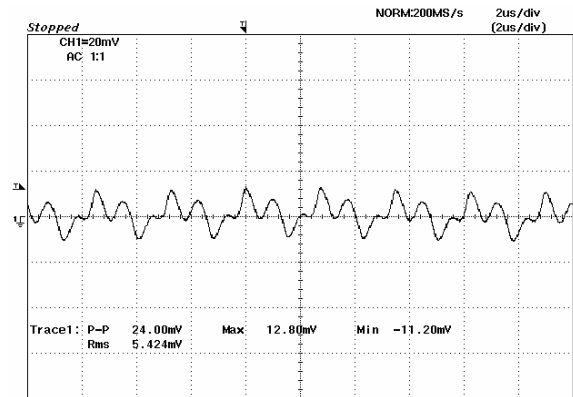

Figure 9: Output ripple & noise at 12Vin, 5.0V/6A out

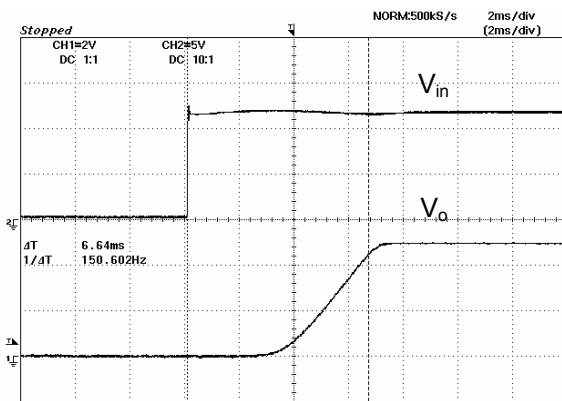

Figure 10: Turn on delay time at 12vin, 5.0V/6A out

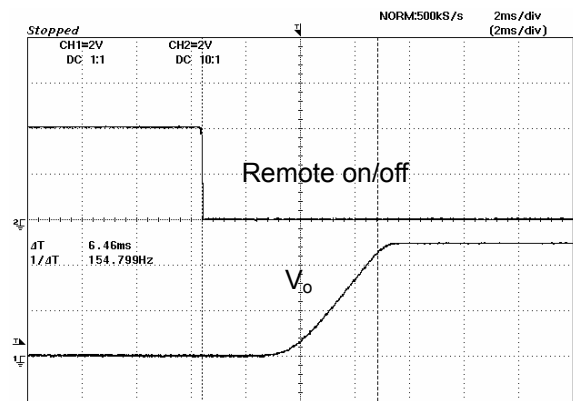

Figure 11: Turn on delay time at Remote On/Off, 5.0V/6A out

ELECTRICAL CHARACTERISTICS CURVES

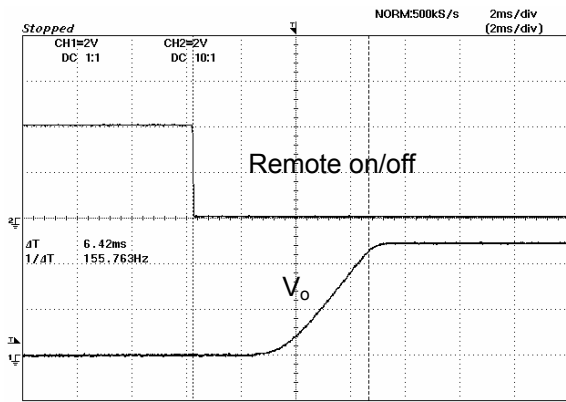

Figure 12: Turn on Using Remote On/Off with external capacitors ($C_o = 3000 \mu\text{F}$), 5.0V/6A out

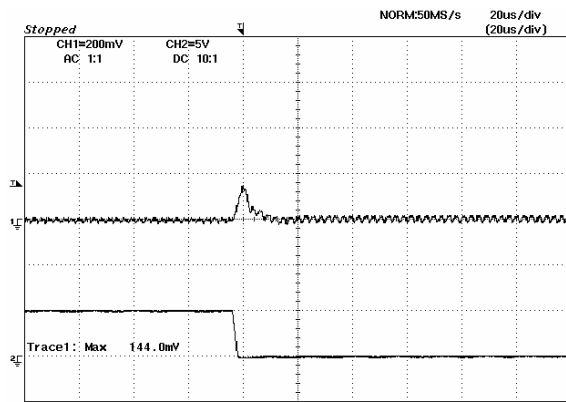

Figure 13: Typical transient response to step load change at $2.5\text{A}/\mu\text{s}$ from 100% to 50% of I_o , max at 12Vin, 5.0V out ($C_{out} = 1\mu\text{F}$ ceramic, $10\mu\text{F}$ tantalum) $I_o: 2\text{A}/\text{DIV}$

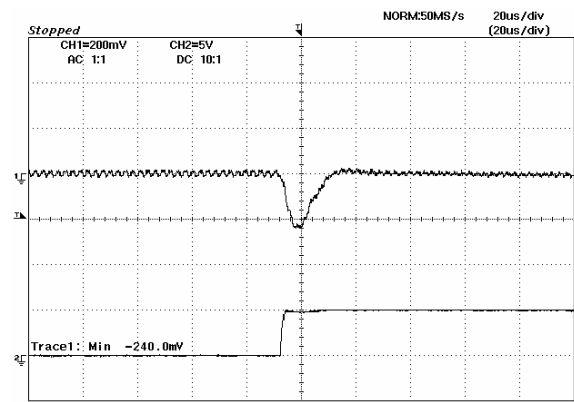

Figure 14: Typical transient response to step load change at $2.5\text{A}/\mu\text{s}$ from 50% to 100% of I_o , max at 12Vin, 5.0V out ($C_{out} = 1\mu\text{F}$ ceramic, $10\mu\text{F}$ tantalum) $I_o: 2\text{A}/\text{DIV}$

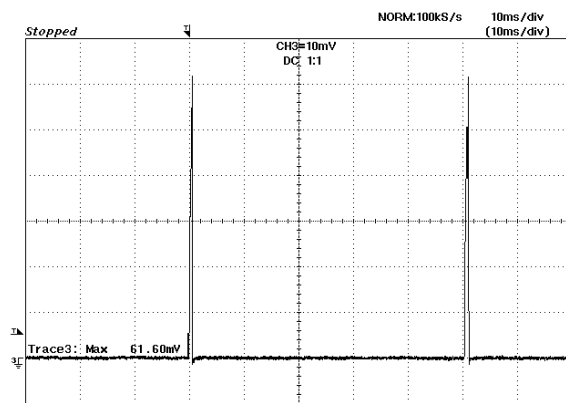

Figure 15: Output short circuit current 12Vin, 0.75Vout (5A/div)

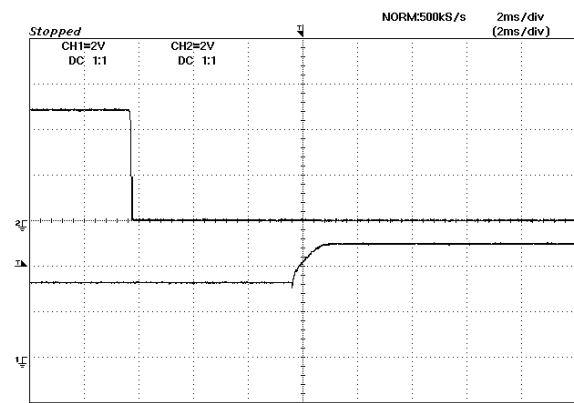
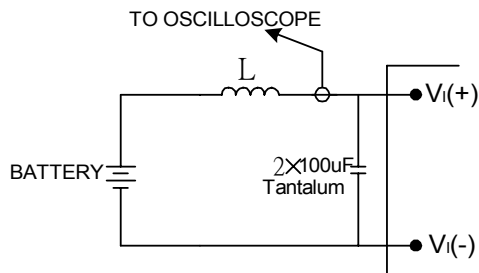

Figure 16: Turn on with Prebias 12Vin, 5V/0A out, $V_{bias} = 3.3\text{Vdc}$

TEST CONFIGURATIONS



Note: Input reflected-ripple current is measured with a simulated source inductance. Current is measured at the input of the module.

Figure 17: Input reflected-ripple test setup

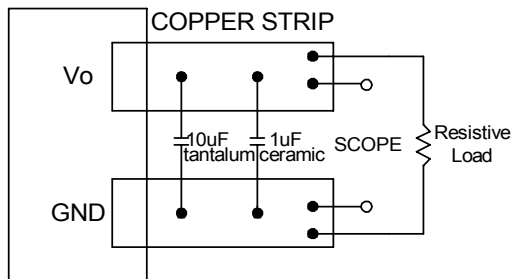

Note: Use a 10µF tantalum and 1µF capacitor. Scope measurement should be made using a BNC connector.

Figure 18: Peak-peak output noise and startup transient measurement test setup

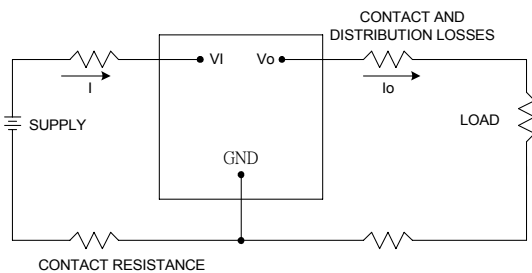

Figure 19: Output voltage and efficiency measurement test setup

Note: All measurements are taken at the module terminals. When the module is not soldered (via socket), place Kelvin connections at module terminals to avoid measurement errors due to contact resistance.

$$\eta = \left(\frac{V_o \times I_o}{V_i \times I_i} \right) \times 100 \quad \%$$

DS_DNS10SIP06_03092009

DESIGN CONSIDERATIONS

Input Source Impedance

To maintain low-noise and ripple at the input voltage, it is critical to use low ESR capacitors at the input to the module. Figure 20 shows the input ripple voltage (mVp-p) for various output models using 2x47 uF low ESR tantalum capacitors (SANYO P/N:16TQC47M, 47uF/16V or equivalent) and 2x22 uF very low ESR ceramic capacitors (TDK P/N:C3225X7S1C226MT, 22uF/16V or equivalent).

The input capacitance should be able to handle an AC ripple current of at least:

$$I_{rms} = I_{out} \sqrt{\frac{V_{out}}{V_{in}} \left(1 - \frac{V_{out}}{V_{in}} \right)} \quad A_{rms}$$

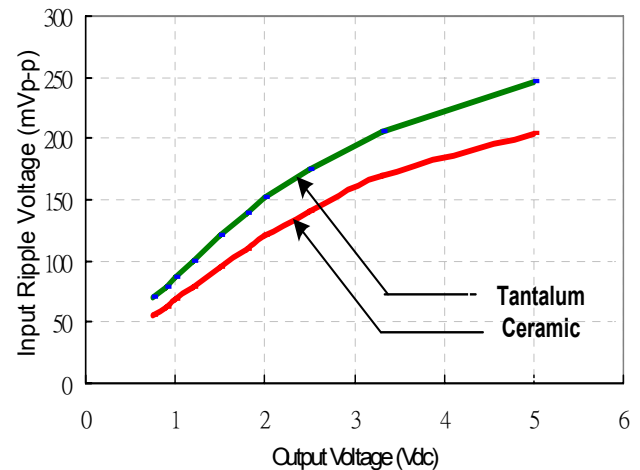

Figure 20: Input ripple voltage for various Output models, $I_o = 6A$ ($C_{in} = 2x47\mu F$ tantalum capacitors and $2x22\mu F$ ceramic capacitors at the input)

DESIGN CONSIDERATIONS (CON.)

The power module should be connected to a low ac-impedance input source. Highly inductive source impedances can affect the stability of the module. An input capacitance must be placed close to the modules input pins to filter ripple current and ensure module stability in the presence of inductive traces that supply the input voltage to the module.

Safety Considerations

For safety-agency approval the power module must be installed in compliance with the spacing and separation requirements of the end-use safety agency standards.

For the converter output to be considered meeting the requirements of safety extra-low voltage (SELV), the input must meet SELV requirements. The power module has extra-low voltage (ELV) outputs when all inputs are ELV.

The input to these units is to be provided with a maximum 6A of glass type fast-acting fuse in the ungrounded lead.

FEATURES DESCRIPTIONS

Remote On/Off

The DNS series power modules have an On/Off pin for remote On/Off operation. Both positive and negative On/Off logic options are available in the DNS series power modules.

For positive logic module, connect an open collector (NPN) transistor or open drain (N channel) MOSFET between the On/Off pin and the GND pin (see figure 21). Positive logic On/Off signal turns the module ON during the logic high and turns the module OFF during the logic low. When the positive On/Off function is not used, leave the pin floating or tie to V_{in} (module will be On).

For negative logic module, the On/Off pin is pulled high with an external pull-up resistor (see figure 22) Negative logic On/Off signal turns the module OFF during logic high and turns the module ON during logic low. If the negative On/Off function is not used, leave the pin floating or tie to GND. (module will be On)

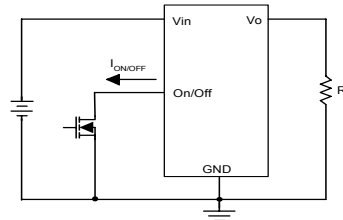

Figure 21: Positive remote On/Off implementation

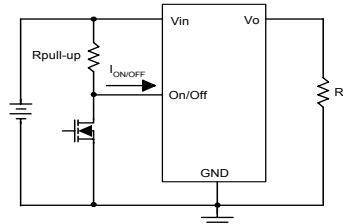

Figure 22: Negative remote On/Off implementation

Over-Current Protection

To provide protection in an output over load fault condition, the unit is equipped with internal over-current protection. When the over-current protection is triggered, the unit enters hiccup mode. The units operate normally once the fault condition is removed.

FEATURES DESCRIPTIONS (CON.)

Over-Temperature Protection

The over-temperature protection consists of circuitry that provides protection from thermal damage. If the temperature exceeds the over-temperature threshold the module will shut down. The module will try to restart after shutdown. If the over-temperature condition still exists during restart, the module will shut down again. This restart trial will continue until the temperature is within specification.

Output Voltage Programming

The output voltage of the DNS can be programmed to any voltage between 0.75Vdc and 5.0Vdc by connecting one resistor (shown as Rtrim in Figure 23) between the TRIM and GND pins of the module. Without this external resistor, the output voltage of the module is 0.7525 Vdc. To calculate the value of the resistor Rtrim for a particular output voltage Vo, please use the following equation:

$$R_{trim} := \left(\frac{10500}{V_o - 0.7525} - 1000 \right) \cdot \Omega$$

Rtrim is the external resistor in Ω
Vo is the desired output voltage

For example, to program the output voltage of the DNS module to 3.3Vdc, Rtrim is calculated as follows:

$$R_{trim} := \left(\frac{10500}{2.5475} - 1000 \right) \cdot \Omega$$

$$R_{trim} = 3.122 \text{ k}\Omega$$

DNS can also be programmed by applying a voltage between the TRIM and GND pins (Figure 24). The following equation can be used to determine the value of Vtrim needed for a desired output voltage Vo:

$$V_{trim} := 0.7 - [(V_o - 0.7525) \cdot 0.0667]$$

Vtrim is the external voltage in V
Vo is the desired output voltage

For example, to program the output voltage of a DNS module to 3.3 Vdc, Vtrim is calculated as follows

$$V_{trim} := 0.7 - (2.5475 \cdot 0.0667)$$

$$V_{trim} = 0.530V$$

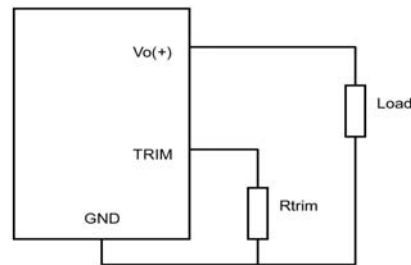

Figure 23: Circuit configuration for programming output voltage using an external resistor

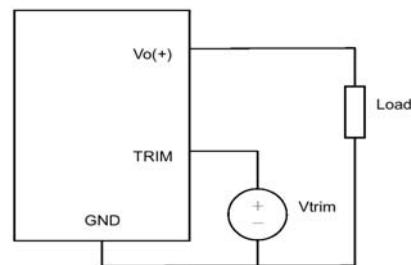

Figure 24: Circuit Configuration for programming output voltage using external voltage source

FEATURE DESCRIPTIONS (CON.)

Table 1 provides Rtrim values required for some common output voltages, while Table 2 provides value of external voltage source, Vtrim, for the same common output voltages. By using a 1% tolerance trim resistor, set point tolerance of $\pm 2\%$ can be achieved as specified in the electrical specification.

Table 1

VO (V)	Rtrim (K Ω)
0.7525	Open
1.2	22.464
1.5	13.047
1.8	9.024
2.5	5.009
3.3	3.122
5.0	1.472

Table 2

VO (V)	Vtrim (V)
0.7525	Open
1.2	0.670
1.5	0.650
1.8	0.630
2.5	0.583
3.3	0.530
5.0	0.4167

The amount of power delivered by the module is the voltage at the output terminals multiplied by the output current. When using the trim feature, the output voltage of the module can be increased, which at the same output current would increase the power output of the module. Care should be taken to ensure that the maximum output power of the module must not exceed the maximum rated power ($V_{o.set} \times I_{o.max} \leq P_{max}$).

Voltage Margining

Output voltage margining can be implemented in the DNS modules by connecting a resistor, $R_{margin-up}$, from the Trim pin to the ground pin for margining-up the output voltage and by connecting a resistor, $R_{margin-down}$, from the Trim pin to the output pin for margining-down. Figure 25 shows the circuit configuration for output voltage margining. If unused, leave the trim pin unconnected. A calculation tool is available from the evaluation procedure, which computes the values of $R_{margin-up}$ and $R_{margin-down}$ for a specific output voltage and margin percentage.

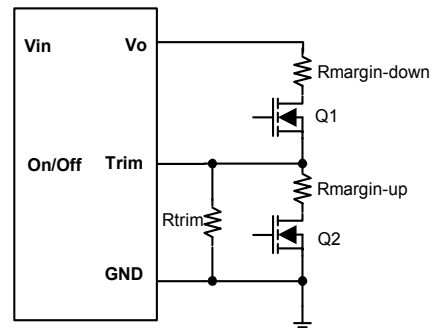

Figure 25: Circuit configuration for output voltage margining

Voltage Tracking

The DNS family was designed for applications that have output voltage tracking requirements during power-up and power-down. The devices have a TRACK pin to implement three types of tracking method: sequential start-up, simultaneous and ratio-metric. TRACK simplifies the task of supply voltage tracking in a power system by enabling modules to track each other, or any external voltage, during power-up and power-down.

By connecting multiple modules together, customers can get multiple modules to track their output voltages to the voltage applied on the TRACK pin.



FEATURE DESCRIPTIONS (CON.)

The output voltage tracking feature (Figure 26 to Figure 28) is achieved according to the different external connections. If the tracking feature is not used, the TRACK pin of the module can be left unconnected or tied to Vin.

For proper voltage tracking, input voltage of the tracking power module must be applied in advance, and the remote on/off pin has to be in turn-on status. (Negative logic: Tied to GND or unconnected. Positive logic: Tied to Vin or unconnected)

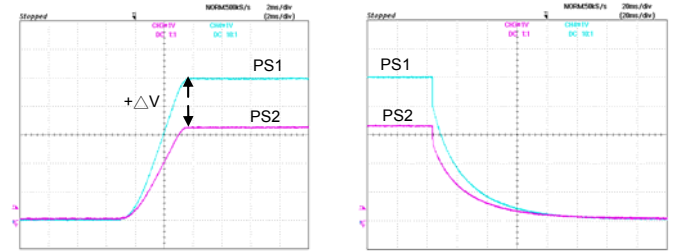

Figure 28: Ratio-metric

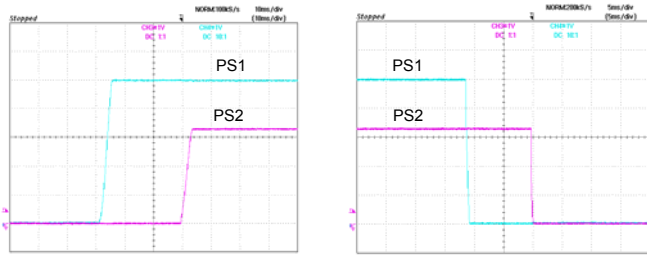

Figure 26: Sequential

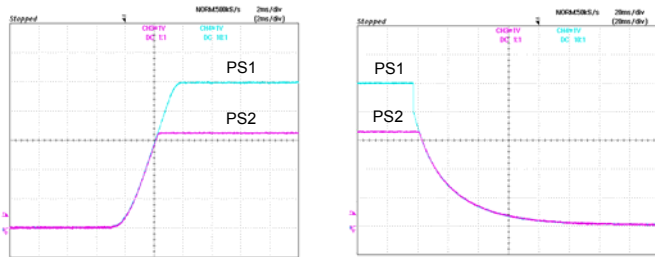
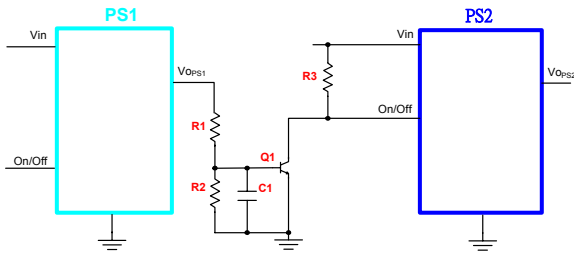

Figure 27: Simultaneous

FEATURE DESCRIPTIONS (CON.)

Sequential Start-up

Sequential start-up (Figure 26) is implemented by placing an On/Off control circuit between $V_{O_{PS1}}$ and the On/Off pin of PS2.



Simultaneous

Simultaneous tracking (Figure 27) is implemented by using the TRACK pin. The objective is to minimize the voltage difference between the power supply outputs during power up and down.

The simultaneous tracking can be accomplished by connecting $V_{O_{PS1}}$ to the TRACK pin of PS2. Please note the voltage apply to TRACK pin needs to always higher than the $V_{O_{PS2}}$ set point voltage.

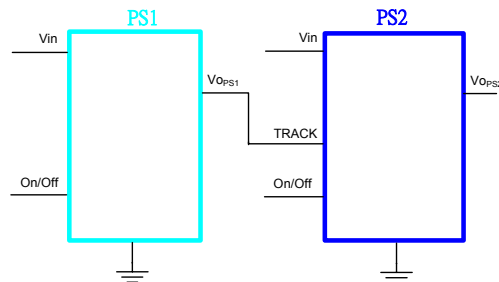

Ratio-Metric

Ratio-metric (Figure 28) is implemented by placing the voltage divider on the TRACK pin that comprise R1 and R2, to create a proportional voltage with $V_{O_{PS1}}$ to the Track pin of PS2.

For Ratio-Metric applications that need the outputs of PS1 and PS2 reach the regulation set point at the same time.

The following equation can be used to calculate the value of R1 and R2.

The suggested value of R2 is 10kΩ.

$$\frac{V_{O,PS2}}{V_{O,PS1}} = \frac{R_2}{R_1 + R_2}$$

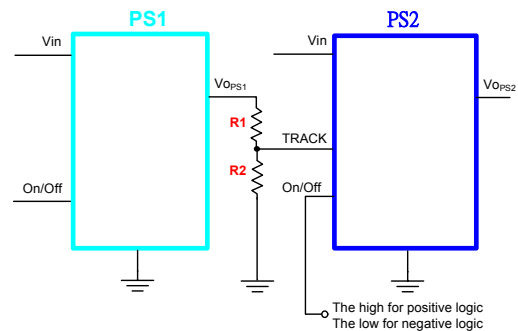

THERMAL CONSIDERATIONS

Thermal management is an important part of the system design. To ensure proper, reliable operation, sufficient cooling of the power module is needed over the entire temperature range of the module. Convection cooling is usually the dominant mode of heat transfer.

Hence, the choice of equipment to characterize the thermal performance of the power module is a wind tunnel.

Thermal Testing Setup

Delta's DC/DC power modules are characterized in heated vertical wind tunnels that simulate the thermal environments encountered in most electronics equipment. This type of equipment commonly uses vertically mounted circuit cards in cabinet racks in which the power modules are mounted.

The following figure shows the wind tunnel characterization setup. The power module is mounted on a test PWB and is vertically positioned within the wind tunnel. The height of this fan duct is constantly kept at 25.4mm (1").

Thermal Derating

Heat can be removed by increasing airflow over the module. To enhance system reliability, the power module should always be operated below the maximum operating temperature. If the temperature exceeds the maximum module temperature, reliability of the unit may be affected.

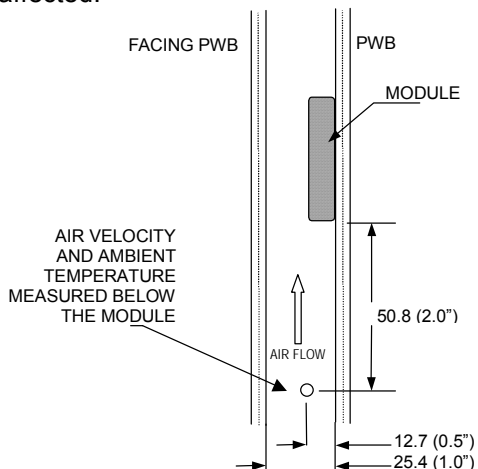

Note: Wind Tunnel Test Setup Figure Dimensions are in millimeters and (Inches)

Figure 29: Wind tunnel test setup



THERMAL CURVES

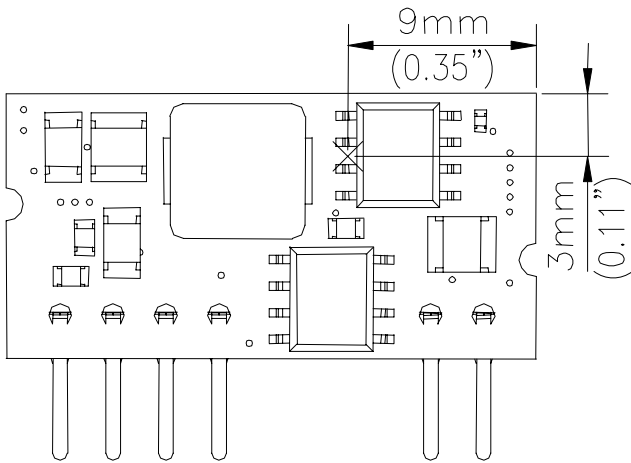

Figure 30: Temperature measurement location
The allowed maximum hot spot temperature is defined at 120 °C

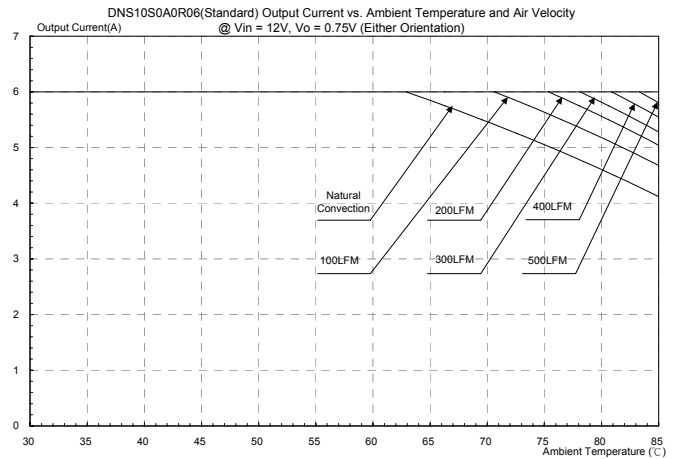

Figure 33: DNS0A0R06(Standard) Output current vs. ambient temperature and air velocity @ Vin=12V, Vout=0.75V (Either Orientation)

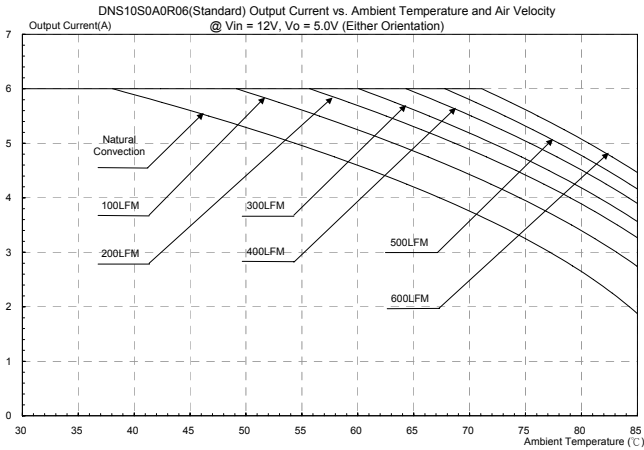

Figure 31: DNS0A0R06(Standard) Output current vs. ambient temperature and air velocity @ Vin=12V, Vout=5.0V (Either Orientation)

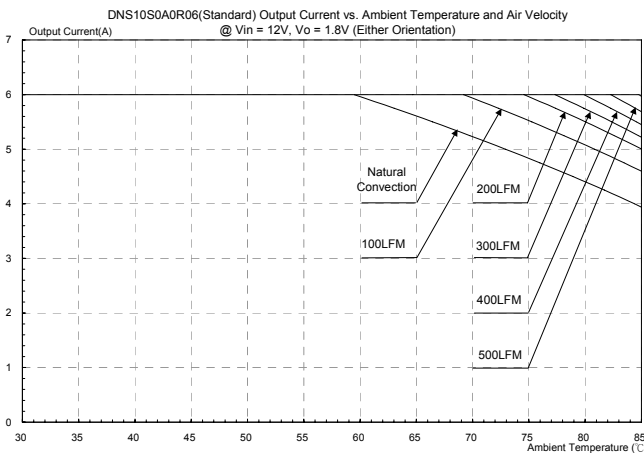
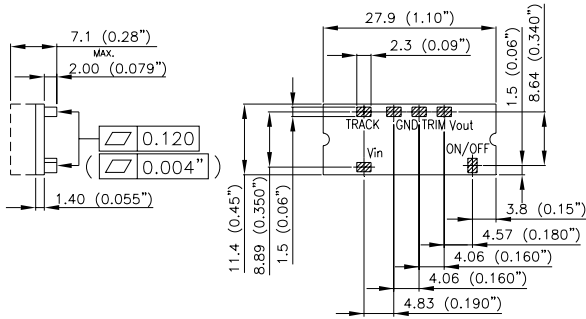

Figure 32: DNS0A0R06(Standard) Output current vs. ambient temperature and air velocity @ Vin=12V, Vout=1.8V (Either Orientation)

DS_DNS10SIP06_03092009

MECHANICAL DRAWING

SMD PACKAGE (OPTIONAL)



SIDE VIEW

BOTTOM VIEW

SIP PACKAGE

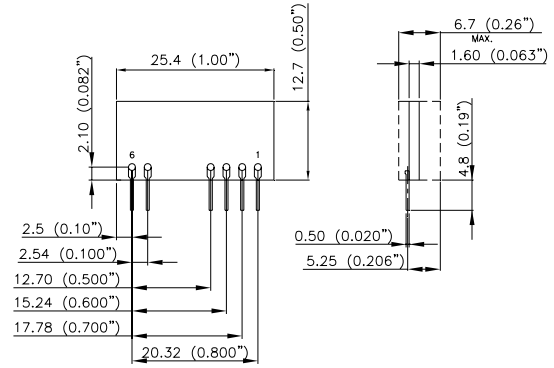

BACK VIEW

SIDE VIEW

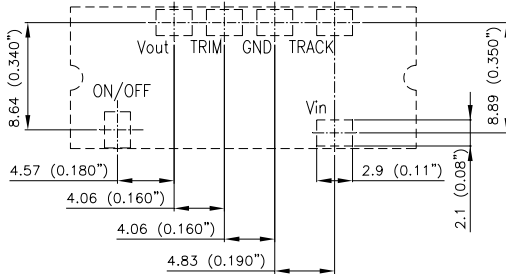

RECOMMENDED PWB PAD LAYOUT

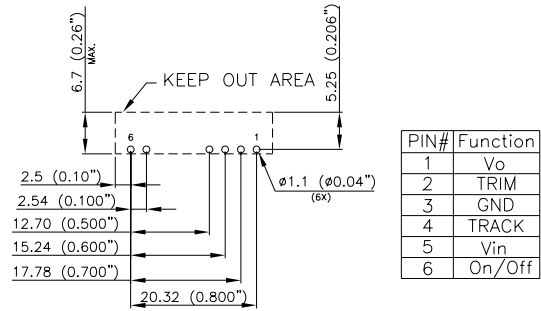

RECOMMENDED PWB PAD LAYOUT

NOTES:
 DIMENSIONS ARE IN MILLIMETERS AND (INCHES)
 TOLERANCES: X.Xmm±0.5mm(X.XX in.±0.02 in.)
 X.XXmm±0.25mm(X.XXX in.±0.010 in.)

PART NUMBERING SYSTEM

DNS	10	S	0A0	R	06	P	F	D
Product Series	Input Voltage	Numbers of Outputs	Output Voltage	Package Type	Output Current	On/Off logic		Option Code
DNS - 6A DNM - 10A DNL - 16A	04 - 2.8V ~ 5.5V 10 - 8.3V ~ 14V	S - Single	0A0 - Programmable	R - SIP S - SMD	06 - 6A	N- negative P- positive	F- RoHS 6/6 (Lead Free)	D - Standard Function

MODEL LIST

Model Name	Packaging	Input Voltage	Output Voltage	Output Current	On/Off logic	Efficiency 12Vin @ 100% load
DNS10S0A0R06NFD	SIP	8.3V ~ 14V	0.75V ~ 5.0V	6A	Negative	89.5% (3.3V)
DNS10S0A0R06PFD	SIP	8.3V ~ 14V	0.75V ~ 5.0V	6A	Positive	89.5% (3.3V)
DNS10S0A0S06NFD	SMD	8.3V ~ 14V	0.75V ~ 5.0V	6A	Negative	89.5% (3.3V)
DNS10S0A0S06PFD	SMD	8.3V ~ 14V	0.75V ~ 5.0V	6A	Positive	89.5% (3.3V)

CONTACT: www.delta.com.tw/dcdc

USA:

Telephone:
East Coast: (888) 335 8201
West Coast: (888) 335 8208
Fax: (978) 656 3964
Email: DCDC@delta-corp.com

Europe:

Phone: +41 31 998 53 11
Fax: +41 31 998 53 53
Email: DCDC@delta-es.com

Asia & the rest of world:

Telephone: +886 3 4526107
ext 6220~6224
Fax: +886 3 4513485
Email: DCDC@delta.com.tw

WARRANTY

Delta offers a two (2) year limited warranty. Complete warranty information is listed on our web site or is available upon request from Delta.

Information furnished by Delta is believed to be accurate and reliable. However, no responsibility is assumed by Delta for its use, nor for any infringements of patents or other rights of third parties, which may result from its use. No license is granted by implication or otherwise under