

Typical unit

## FEATURES

- Non-isolated Point-of-Load (POL) converter, ideal for mixed voltage systems
- Optimized for CPUs, DSPs and programmable logic - FPGAs, ASICs
- 30 Amps maximum output current
- User-selectable output voltage, 0.8Vdc to 5.0Vdc via trim resistor or voltage input
- Wide input range 6Vdc to 14Vdc ( $V_{OUT} < 3.6V$ )
- Selectable phased start-up sequencing and tracking
- Excellent efficiency over output voltage range
- Two models available, with or without additional ground/thermal pads
- Fast settling, high di/dt slew rate, low output noise
- Extensive self protection plus 'hiccup' short circuit auto recovery
- Meets full safety and emission certification

## DESCRIPTION

Today's high performance CPU and programmable logic devices demand superior performance from their power source. The LSM2-T/30-D12 series DC/DC converters offer up to 30 Amps continuous output power with a user-selectable output of 0.8 to 3.6 Volts. 25 Amps output is available up to 5.0  $V_{OUT}$ . This tiny converter is ideal for applications with an input range of 6 to 14 Volts DC. The pinout, trim system and mechanical footprint is compatible with the DOSA (www.dosapower.com) industry standard.

To ensure very high performance of powered logic systems, the LSM2-T/30-D12 features low output noise, high slew rates (20 Amps/ $\mu$ Sec.), fast transient response (25  $\mu$ Sec settling) and tight line and load regulation. Many logic devices require controlled start up and tracking capabilities. The LSM2-T/30-D12 includes a Sequence/Track function and prebias protection against external startup voltages. Other features include

no additional external components required, stable no-load operation, up to 10,000  $\mu$ F output load capacitance and no reverse conduction.

System functions offer a remote On/Off control, two additional ground pins (optional) and a load Sense input. These converters meet agency standards UL/EN 60950-1, CAN/CSA-C22.2 60950-1, IEC 60950-1, 2nd edition, and EN55022/CISPR22 emissions characterization. The automated surface mount assembly is fully compatible with RoHS (Reduction of Hazardous Substances) construction and attachment. The LSM2-T/30-D12 mounts to its host carrier board via reflow-soldered PCB pads.

The extraordinary efficiency means low heat and freedom from expensive, bulky heat sinks. A wealth of protection features include input under-voltage shutdown, output overcurrent current limiting, short circuit protection and overtemperature shutdown/recycle.

Contents	Page
Description, Photograph	1
Connection Diagram, Ordering Guide, Model Numbering	2
Mechanical Specifications, Input/Output Pinout	3
Detailed Electrical Specifications	4
Soldering Guidelines	5
Performance Data	6



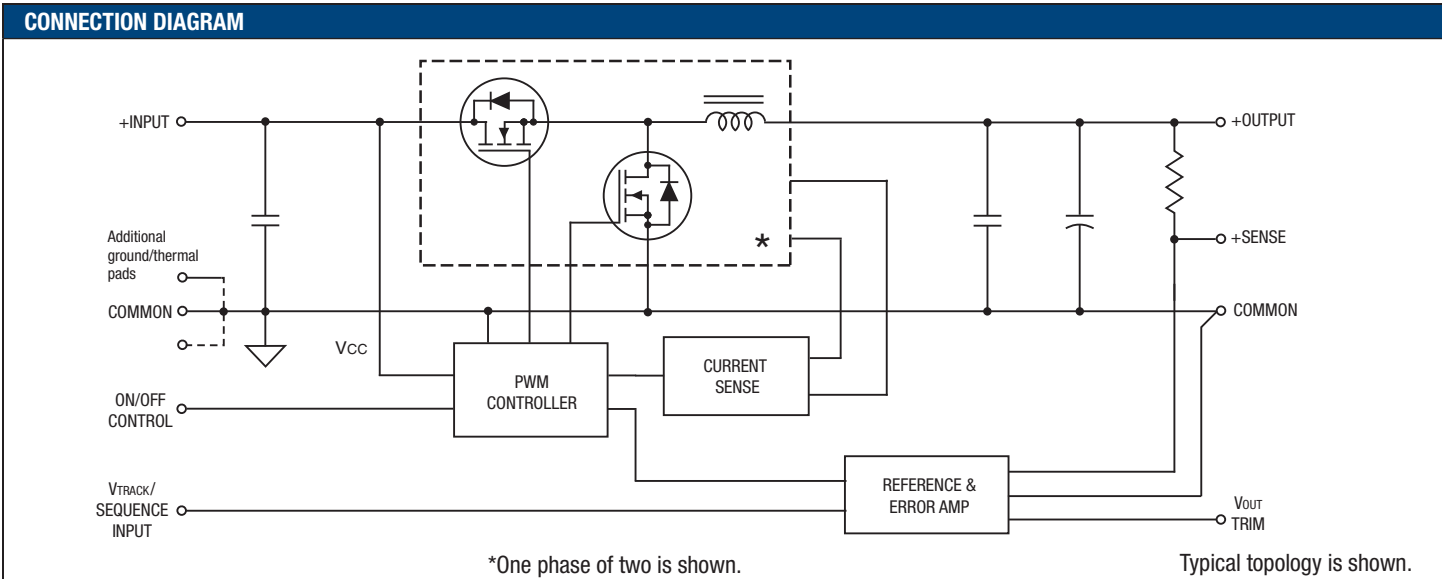

### PERFORMANCE SPECIFICATIONS AND ORDERING GUIDE <sup>①</sup>

Model Family	Output						Input			Efficiency <sup>⑤</sup>		Package (Case/ Pinout)	
	V <sub>OUT</sub> (Volts)	I <sub>OUT</sub> <sup>⑥</sup> (Amps)	Power (Watts)	R/N (mVp-p) <sup>②</sup>		Regulation (max.) <sup>③</sup>		V <sub>IN</sub> Nom. (Volts)	Range <sup>⑦</sup> (Volts)	I <sub>IN</sub> <sup>④</sup> (mA/A)	Min.		Typ.
				Typ.	Max.	Line	Load						
LSM2-T/30-D12-C	0.8-5	30	125	15	25	±0.2%	±0.4%	12	6-14	210/11.1	92.5%	94%	C71, P72
LSM2-T/30-D12R-C	0.8-5	30	125	15	25	±0.2%	±0.4%	12	6-14	210/11.1	92.5%	94%	C71, P72
LSM2-T/30-D12R-C-CIS	0.8-5	30	125	15	25	±0.2%	±0.4%	12	6-14	210/11.1	92.5%	94%	C71, P72

① Typical @ Ta=+25°C. under nominal line voltage and full-load conditions unless noted. Nominal output is +5 Volts.  
 ② Ripple/Noise (R/N) is tested/specified over a 5 Hz to 20 MHz bandwidth and may be reduced by adding external filtering. R/N is shown at V<sub>OUT</sub> <= 2.5 Volts.  
 ③ These devices have no minimum load requirements and will regulate under no-load conditions. Regulation specifications describe the output voltage deviation as the line voltage or load is varied from its nominal/midpoint value to either extreme.  
 ④ Nominal line voltage, no-load/full-load conditions.  
 ⑤ LSM2-T/30-D12 efficiencies are shown at V<sub>OUT</sub> = 5 Volts.  
 ⑥ I<sub>OUT</sub> max. is 30 Amps with V<sub>OUT</sub> = 0.8 to 3.6 Volts. With V<sub>OUT</sub> > 3.6 Volts, I<sub>OUT</sub> max. is 25 Amps.  
 ⑦ If V<sub>OUT</sub> > 3.63V, input range is 7-14V.  
 ⑧ LSM2-T/30-D12R-C-CIS models use a 100KΩ resistor between the gate and source of the internal On/Off (Enable) FET controlling the PWM.

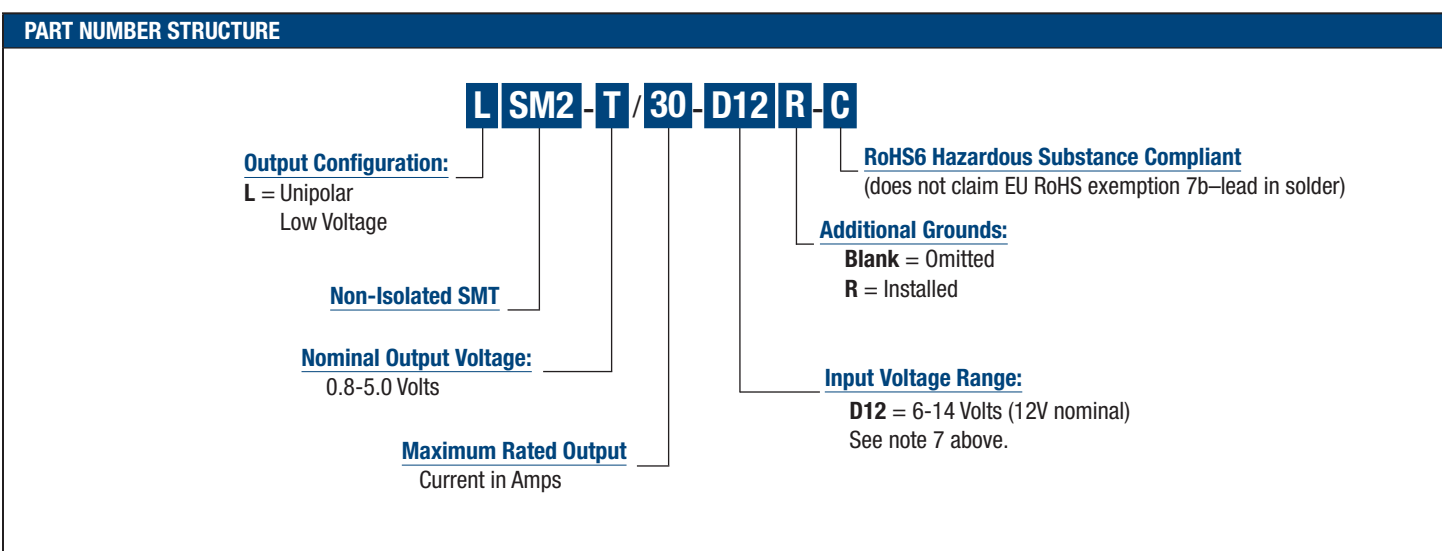

## MECHANICAL SPECIFICATIONS

### Case C71

Component locations are typical.

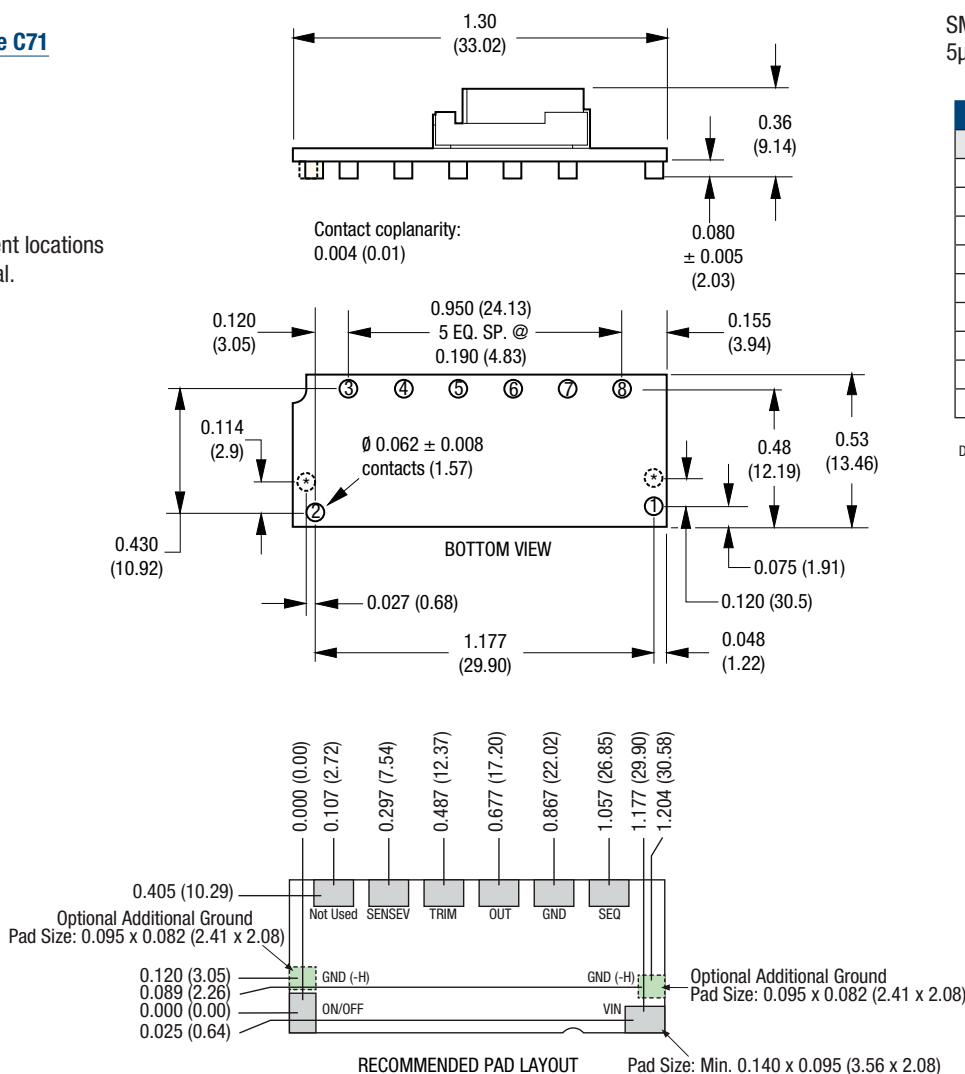

SMT contacts: copper alloy with 5μ " Au (min.) over 50μ " Ni (min.)

### INPUT/OUTPUT CONNECTIONS P72

Pad	Function
1	On/Off Control
2	+Input
3	Sequence/Track In
4	Common
5	+Output
6	Trim
7	Sense In
8	Not used
*	Additional Ground (optional)

Dimensions are in inches (mm) shown for ref. only.

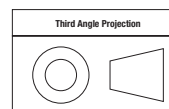

Tolerances (unless otherwise specified):  
 .XX ± 0.02 (0.5)  
 .XXX ± 0.010 (0.25)  
 Angles ± 2°

Components are shown for reference only.

### Additional Ground/Thermal Pads ("R" models)

The LSM2-T/30-D12 is optionally available with two additional ground pads for increased current handling and better heat transfer. These are indicated with the "R" designator in the model number, LSM2-T/30-D12R-C. MPS recommends that users lay out their PC boards to accept these two pads for larger current applications. Please note that the Derating curves for the "R" models accept higher temperature and greater current limits than units without the additional pads.

To realize the additional current and thermal capacity of "R" models, you must have a substantial area of several square inches of copper etch flow-soldered to these pads and sufficient feed-throughs or other means of conducting current. The "R" pads and the standard pads 1 and 2 are in parallel.

If your application uses a standard DOSA pad layout and you cannot connect to these ground pads, order model LSM2-T/30-D12-C without the "R" designator. Please observe the lower Derating curves for standard, "non-R" models.

### Performance and Functional Specifications

See Note 1

Input	
<b>Input Voltage Range</b>	See Ordering Guide
<b>Isolation</b>	Not isolated. Input and output Commons are internally connected.
<b>Start-Up Voltage</b>	5.6 Volts
<b>Undervoltage Shutdown</b>	5 Volts
<b>Overvoltage Shutdown</b>	None
<b>Reflected (Back) Ripple Current (Note 2)</b>	50 mA pk-pk
<b>Internal Input Filter Type</b>	Capacitive
<b>Reverse Polarity Protection</b>	None, install external fuse.
<b>Recommended External Fuse</b>	35 Amps, fast blow
<b>Input Current:</b>	
Full Load Conditions	See Ordering Guide
Inrush Transient	0.4 A <sup>2</sup> Sec.
Shutdown Mode (Off, UV, OT)	5 mA
Output Short Circuit	60 mA
Low Line (VIN=Vmin, 5VOUT)	18.9 Amps
<b>Remote On/Off Control (Note 5)</b>	
Negative Logic (No model suffix)	ON = Open pin or 0 to +0.55 V max. OFF = +3.0V min. to +VIN max.
Current	1.3 mA max.
Output	
<b>Minimum Loading</b>	No minimum load
<b>Accuracy (50% load)</b>	±1.5 % of Vnominal
<b>Voltage Adjustment Range (Note 13)</b>	See Ordering Guide
<b>Overvoltage Protection (Note 20)</b>	None
<b>Temperature Coefficient</b>	±0.01% per °C of VOUT range
<b>Ripple/Noise (20 MHz bandwidth)</b>	See Ordering Guide and Note 8
<b>Line/Load Regulation (See Tech. Notes)</b>	See Ordering Guide and Note 10
<b>Efficiency</b>	See Ordering Guide
<b>Maximum Capacitive Loading (Note 15)</b>	
Cap-ESR=0.001 to 0.01 Ohms	5,000 µF
Cap-ESR >0.01 Ohms	10,000 µF
<b>Current Limit Inception (Note 19)</b>	
(98% of VOUT setting)	48 Amps (cold startup) 42 Amps (after warm up)
<b>Short Circuit Mode (Note 6)</b>	
Short Circuit Current Output	600 mA
Protection Method	Hiccup autorecovery upon overload removal. (Note 17)
Short Circuit Duration	Continuous, no damage (output shorted to ground)
Prebias Startup (Note 16)	Converter will start up if the external output voltage is less than Vnominal.
<b>Sequencing</b>	
Slew Rate	2V per millisecond max.
Startup delay until sequence start	10 milliseconds min.
Tracking accuracy, rising input	VOUT=±100 mV of Sequence In
Tracking accuracy, falling input	VOUT=±200 mV of Sequence In
<b>Remote Sense to Vout</b>	0.5V max. (Note 7)

Dynamic Characteristics	
<b>Dynamic Load Response</b> (50-100-50% load step, di/dt=20A/µSec)	60 µSec to within ±2% of final value
<b>Start-Up Time</b> (VIN on to VOUT regulated or On/Off to VOUT)	10 mSec for VOUT=nominal
<b>Switching Frequency</b>	430 KHz
Environmental	
<b>Calculated MTBF (4)</b>	3,917,077 Hours
Operating Temperature Range With derating	-40 to +85°C. (Note 9) See Derating Curves (Note 12)
<b>Storage Temperature Range</b>	-55 to +125°C.
<b>Thermal Protection/Shutdown</b>	+115°Celsius
<b>Relative Humidity</b>	to 85%/+85°C, non-condensing
Physical	
<b>Outline Dimensions</b>	See Mechanical Specifications
<b>Weight</b>	0.28 ounces (7.8 grams)
<b>Electromagnetic Interference</b> (conducted and radiated)	Meets EN55022/CISPR22 (may need external filter)
<b>Safety</b>	Meets UL/cUL 60950-1, IEC/EN 60950-1, 2nd edition
Absolute Maximum Ratings	
<b>Input Voltage (Continuous or transient)</b>	+15 Volts
<b>On/Off Control (negative logic)</b>	Zero Volts min. to +VIN max.
<b>Input Reverse Polarity Protection</b>	None, install external fuse.
<b>Output Current (Note 7)</b>	Current-limited. Devices can withstand sustained short circuit without damage.
<b>Storage Temperature</b>	-55 to +125°C.
<b>Lead Temperature</b>	See soldering guidelines

Absolute maximums are stress ratings. Exposure of devices to greater than any of these conditions may adversely affect long-term reliability. Proper operation under conditions other than those listed in the Performance/Functional Specifications Table is not implied nor recommended.

### Specification Notes:

- Specifications are typical at +25°C, VIN=nominal (+12V), VOUT=nominal (+5V), full load, external caps and natural convection unless otherwise indicated. Tests at full power should supply substantial forced airflow.
- All models are tested and specified with external 0.1µF and 10µF paralleled ceramic/tantalum output capacitors and a 22µF external input capacitor. All capacitors are low ESR types. These capacitors are necessary to accommodate our test equipment and may not be required to achieve specified performance in your applications. All models are stable and regulate within spec under no-load conditions.
- Input Back Ripple Current is tested and specified over a 5 Hz to 20 MHz bandwidth. Input filtering is CIN=2 x 100 µF tantalum, Cbus=1000 µF electrolytic, Lbus=1 µH.
- Note that Maximum Power Derating curves indicate an **average** current at nominal input voltage. At higher temperatures and/or lower airflow, the DC/DC converter will tolerate brief full current outputs if the total RMS current over time does not exceed the Derating curve.
- Mean Time Before Failure is calculated using the Telcordia (Belcore) SR-332 Method 1, Case 3, ground fixed conditions, Tpcboard=+25°C, full output load, natural air convection.
- The On/Off Control may be driven with external logic or by applying appropriate external voltages which are referenced to -Input Common. The On/Off Control Input should use either an open collector/open drain transistor or logic gate which does not exceed +VIN.
- Short circuit shutdown begins when the output voltage degrades approximately 2% from the selected setting.

**Specification Notes continued:**

- (7) If Sense is connected remotely at the load, up to 0.5 Volts difference is allowed between the Sense and +Vout pins to compensate for ohmic voltage drop in the power lines. A larger voltage drop may cause the converter to exceed maximum power dissipation.
- (8) Output noise may be further reduced by adding an external filter. See I/O Filtering and Noise Reduction.
- (9) All models are fully operational and meet published specifications, including "cold start" at -40°C.
- (10) Regulation specifications describe the deviation as the line input voltage or output load current is varied from a nominal midpoint value to either extreme.
- (11) Other input or output voltage ranges will be reviewed under scheduled quantity special order.
- (12) Maximum continuous power requires that all on-board components not exceed +128°C package temperature.
- (13) Do not exceed maximum power specifications when adjusting the output trim.
- (14) The "R" option includes extra ground pads. These pads offer two important features. In addition to carrying extra current, they also help dissipate additional heat. MPS strongly recommends soldering the "R" pads to a thick ground plane with sizable area. **The Operating Temperature specification listed above assumes that these additional ground pads are connected to a substantial ground plane below the converter (at least several square inches).**
- (15) The maximum output capacitive loads depend on the the Equivalent Series Resistance (ESR) of the external output capacitor. Larger caps will reduce output noise but may slow transient response.
- (16) Do not use Pre-bias startup and sequencing together. If you do not use the track function, leave the seq/trk pin open.
- (17) After short circuit shutdown, if the load is partially removed such that the load still exceeds the overcurrent (OC) detection, the converter will remain in hiccup restart mode.
- (18) Output current limiting is disabled at start up to avoid overcurrent shutdown while charging external bypass capacitors.

**Output Adjustments**

The LSM2-T/30-D12 series includes a special output voltage trimming feature which is fully compatible with competitive units. The output voltage may be varied using a single trim resistor from the Trim Input to Power Common.

Use a precision, low-tempco resistor ( $\pm 100$  ppm/°C) mounted close to the converter with short leads. Be aware that the voltage accuracy is  $\pm 1.5\%$  (typical) therefore adjust this resistance to achieve your desired output.

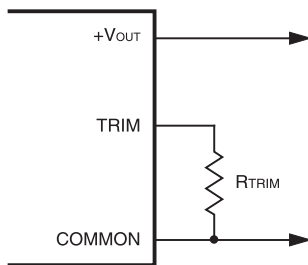

**Figure 1. Trim Resistor Connections**

**Soldering Guidelines**

Murata Power Solutions recommends the specifications below when installing these converters. These specifications vary depending on the solder type. Exceeding these specifications may cause damage to the product. Your production environment may differ therefore please thoroughly review these guidelines with your process engineers.

Reflow Solder Operations for surface-mount products (SMT)			
For Sn/Ag/Cu based solders:		For Sn/Pb based solders:	
Preheat Temperature	Less than 1 °C. per second	Preheat Temperature	Less than 1 °C. per second
Time over Liquidus	45 to 75 seconds	Time over Liquidus	60 to 75 seconds
Maximum Peak Temperature	260 °C.	Maximum Peak Temperature	235 °C.
Cooling Rate	Less than 3 °C. per second	Cooling Rate	Less than 3 °C. per second

**Resistor Trim Equation**

$$R_{TRIM} \text{ (in Ohms)} = \frac{1200}{V_{OUT} - 0.8} - 100$$

The fixed trim resistors to set the output voltage are:

V <sub>OUT</sub>	0.8V.	1.0V.	1.2V.	1.5V.	1.8V.
R <sub>trim</sub> (Ohms)	Open	5.90 KΩ	2.90 KΩ	1.614 KΩ	1.10 KΩ
V <sub>OUT</sub>	2.0V.	2.5V.	3.3V.	5.0V.	
R <sub>trim</sub> (Ohms)	0.90 KΩ	605 Ω	380 Ω	185.71 Ω	

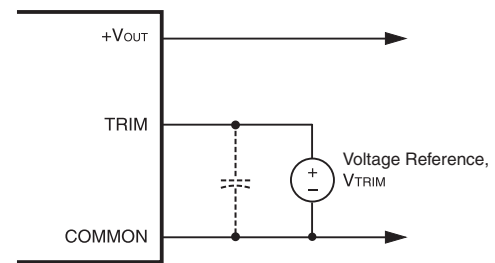

**Figure 2. Voltage Trim Connections**

**Voltage Trim**

The LSM2 Series may also be trimmed using an external low-noise voltage applied between the Trim input and Output Common. Be aware that the internal "load" impedance looking into Trim pin is below 1000 Ohms and includes factors from the output voltage. Therefore, use a low impedance source resistance in your external voltage reference.

The fixed trim voltages to set the output voltage are:

V <sub>OUT</sub> (typ.)	0.80V.	1.0V.	1.2V.	1.5V.	1.8V.
V <sub>trim</sub> (Volts)	Open	0.731V.	0.719V.	0.7V.	0.682V
V <sub>OUT</sub> (typ.)	2.0 V.	2.5V.	3.3V.	5.0V.	
V <sub>trim</sub> (Volts)	0.669V.	0.638V.	0.589V.	0.484V.	

$$V_{trim} = 0.7434 - [(((V_{out} - 0.7434) \div 1620) - 0.000035) \times 100] \text{ where } V_{out} = \text{desired voltage}$$

**PERFORMANCE DATA: OUTPUT VOLTAGE = 5 VOLTS**

Efficiency vs. Line Voltage and Load Current @ +25°C

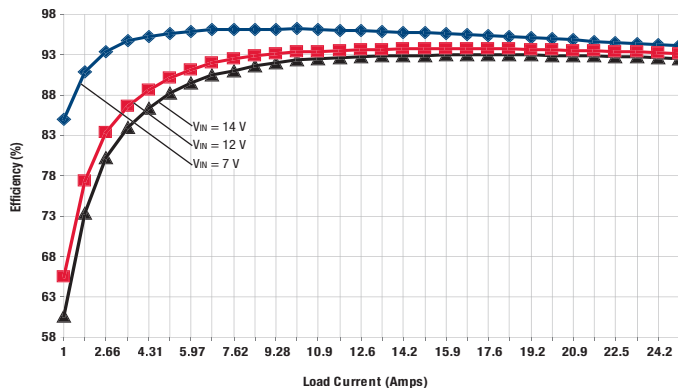

Output Ripple & Noise ( $V_{IN} = 12V$ ,  $I_{OUT} = 20A$ ,  $C_{OUT} = 10\mu F \parallel 1\mu F$ , scope = 20 MHz BW)  
Vertical = 20 mV/div., Sweep = 1μS/div.

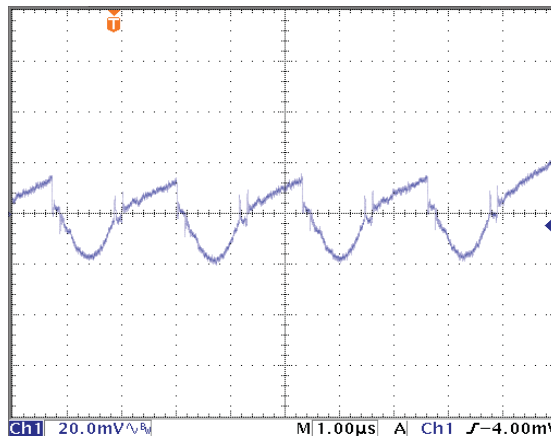

LSM2-T/30-D12R Maximum Current Temperature Derating at Sea Level ( $V_{IN} = 12V$ , Transverse Airflow). *Extra ground pads installed.*

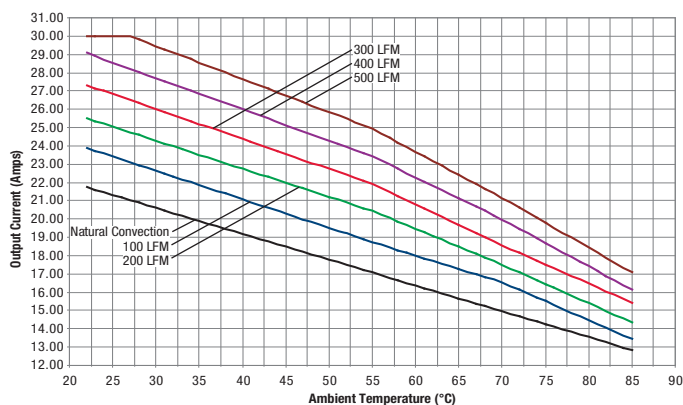

Power-On Startup ( $V_{IN} = 12V$ ,  $I_{OUT} = 25A$ )  
Ch2 = 20 A/div.

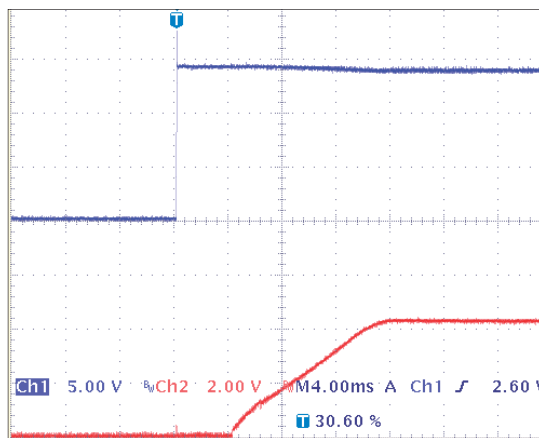

LSM2-T/30-D12 Maximum Current Temperature Derating at Sea Level ( $V_{IN} = 12V$ , Transverse Airflow). *No extra ground pads.*

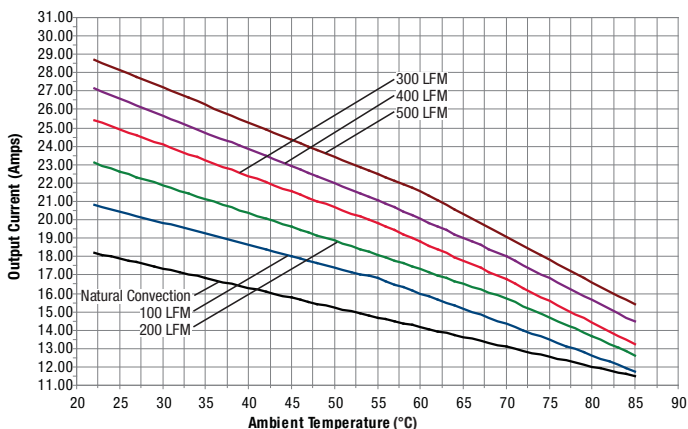

StepLoad Transient Response ( $V_{IN} = 12V$ , 0-15A-0)

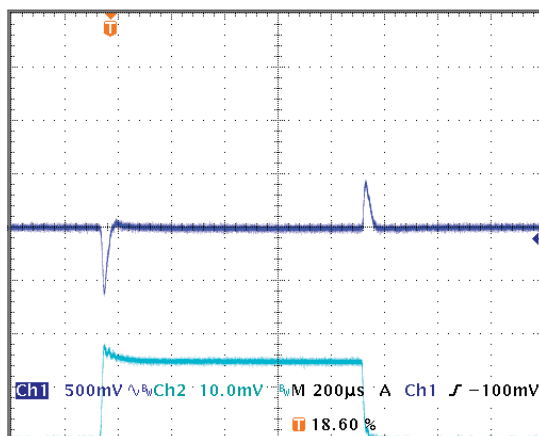



**PERFORMANCE DATA: OUTPUT VOLTAGE = 3.3 VOLTS**

Efficiency vs. Line Voltage and Load Current ( $V_{IN} = 12V$ ) @ +25°C

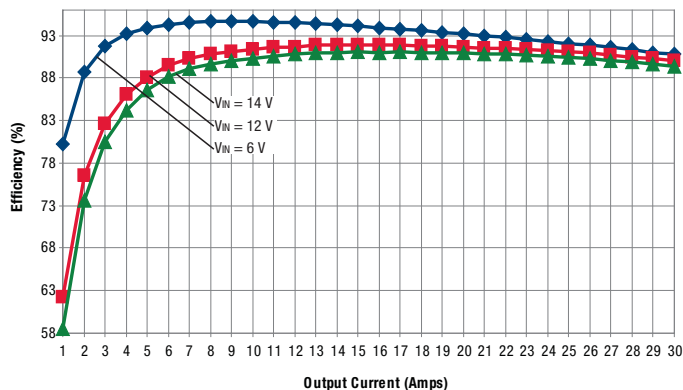

Output Ripple & Noise ( $V_{IN} = 12V$ ,  $I_{OUT} = 20A$ ,  $C_{OUT} = 10\mu F \parallel 1\mu F$ , scope = 20 MHz BW)  
Vertical = 20 mV/div., Sweep = 1μS/div.

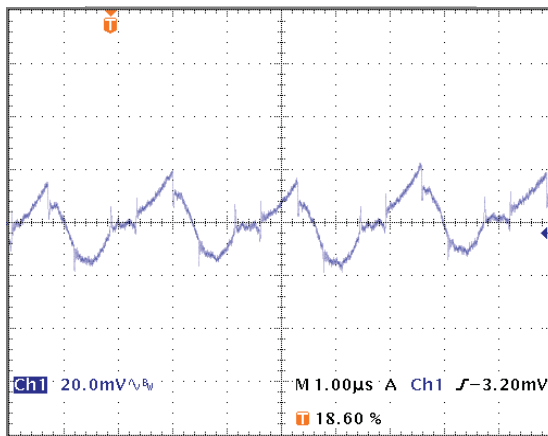

LSM2-T/30-D12R Maximum Current Temperature Derating at Sea Level ( $V_{IN} = 12V$ , Transverse Airflow). *Extra ground pads installed.*

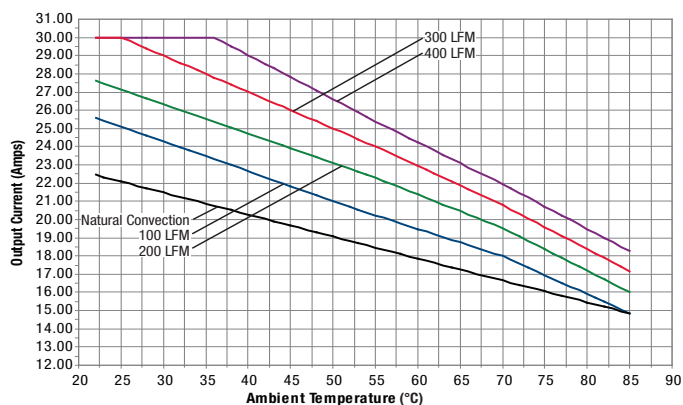

Power-On Startup ( $V_{IN} = 12V$ ,  $I_{OUT} = 25A$ )

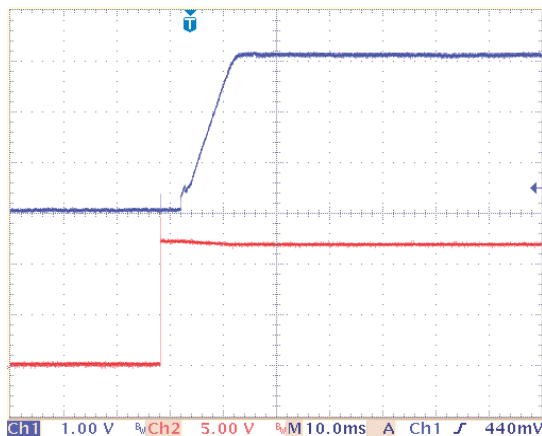

LSM2-T/30-D12 Maximum Current Temperature Derating at Sea Level ( $V_{IN} = 12V$ , Transverse Airflow). *No extra ground pads.*

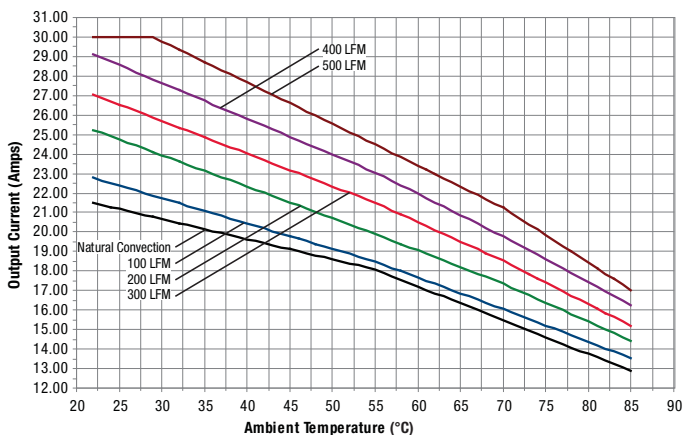

StepLoad Transient Response ( $V_{IN} = 12V$ , 0-15A-0)

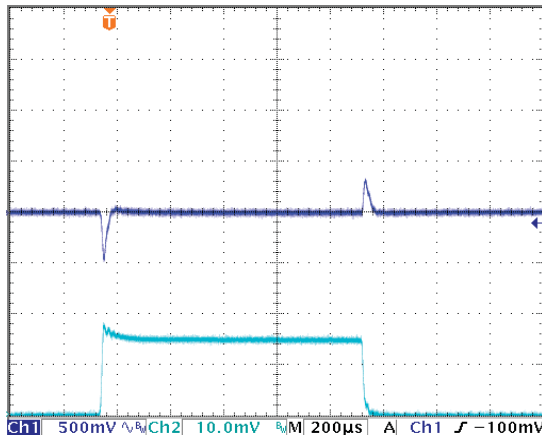

**PERFORMANCE DATA: OUTPUT VOLTAGE = 2.5 VOLTS**

Efficiency vs. Line Voltage and Load Current ( $V_{IN} = 12V$ ) @ +25°C

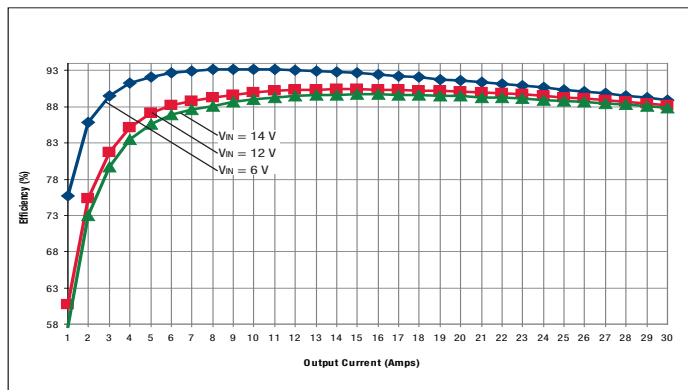

Output Ripple & Noise ( $V_{IN} = 12V$ ,  $I_{OUT} = 20A$ ,  $C_{OUT} = 10\mu F \parallel 1\mu F$ , scope = 20 MHz BW)  
Vertical = 20 mV/div., Sweep = 1μS/div.

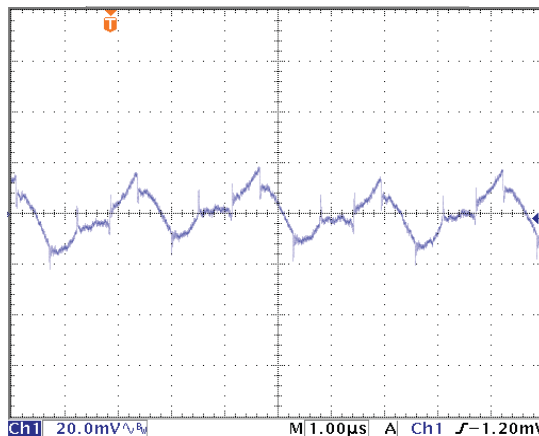

LSM2-T/30-D12R Maximum Current Temperature Derating at Sea Level ( $V_{IN} = 12V$ , Transverse Airflow). *Extra ground pads installed.*

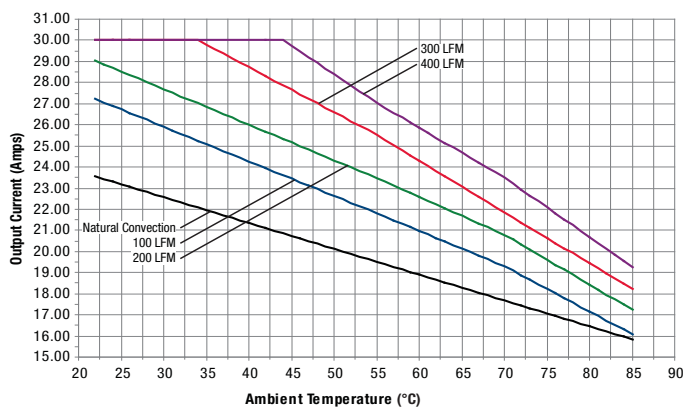

LSM2-T/30-D12 Maximum Current Temperature Derating at Sea Level ( $V_{IN} = 12V$ , Transverse Airflow). *No extra ground pads.*

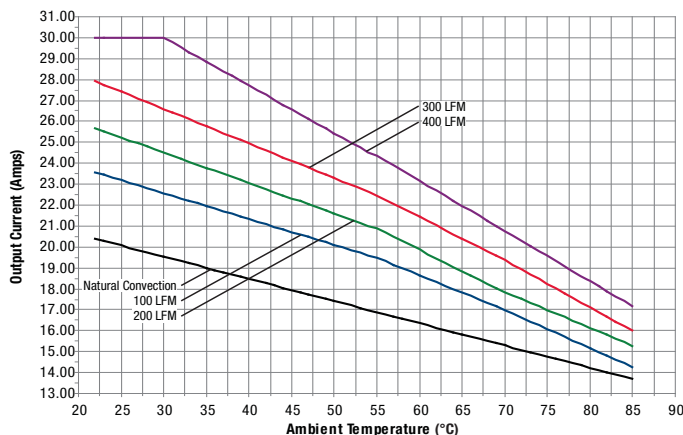

StepLoad Transient Response ( $V_{IN} = 12V$ , 0-15A-0)

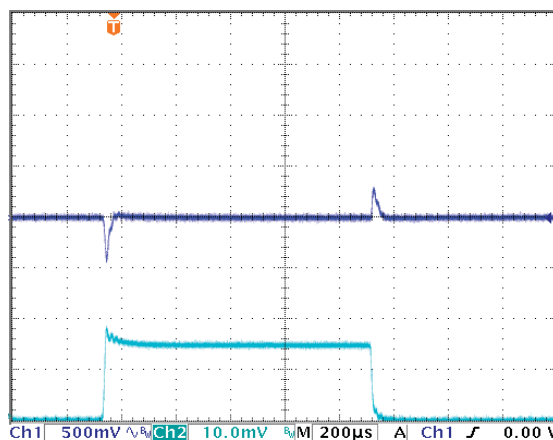



**PERFORMANCE DATA: OUTPUT VOLTAGE = 1.8 VOLTS**

Efficiency vs. Line Voltage and Load Current @ +25°C

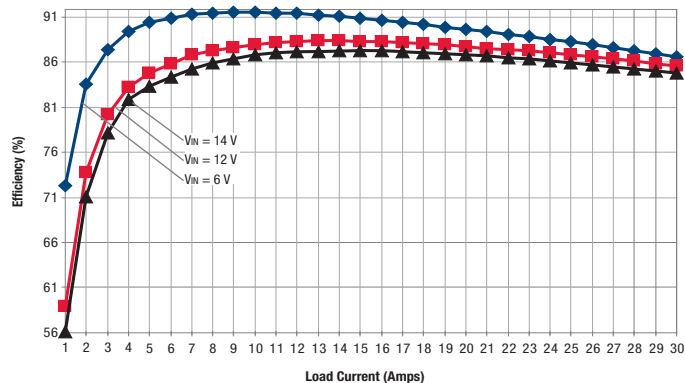

Output Ripple & Noise ( $V_{IN} = 12V$ ,  $I_{OUT} = 20A$ ,  $C_{OUT} = 10\mu F \parallel 1\mu F$ , scope = 20 MHz BW)  
Vertical = 10 mV/div., Sweep = 1μS/div.

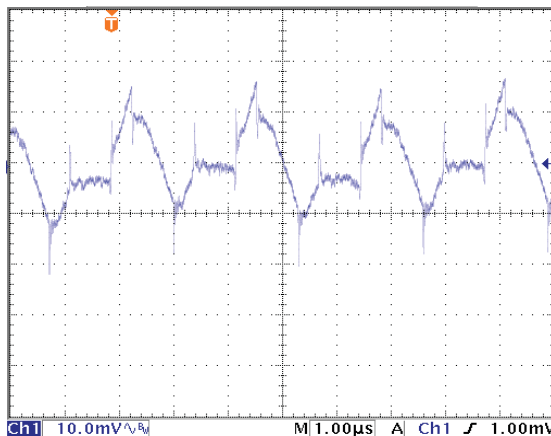

LSM2-T/30-D12R Maximum Current Temperature Derating at Sea Level ( $V_{IN} = 12V$ , Transverse Airflow). *Extra ground pads installed.*

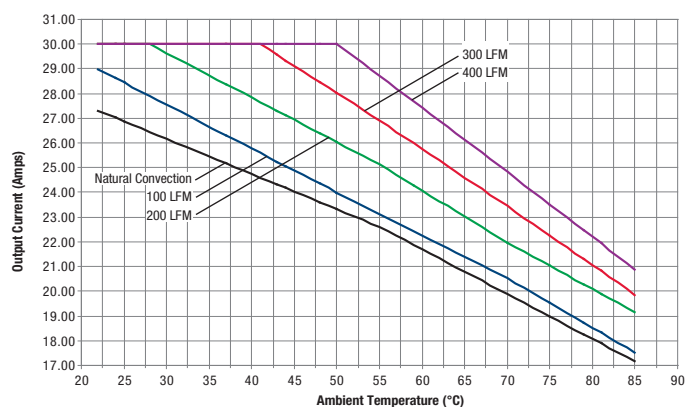

Power-On Startup ( $V_{IN} = 12V$ ,  $I_{OUT} = 25A$ )

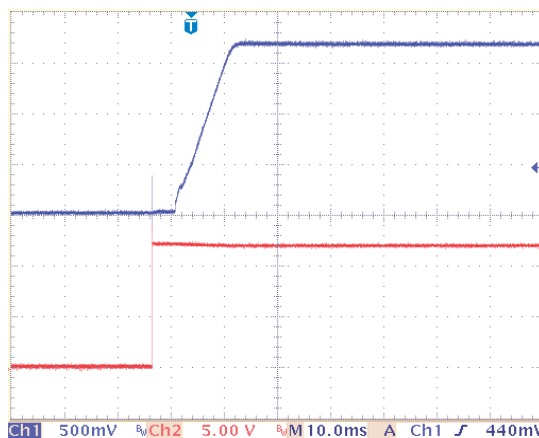

LSM2-T/30-D12 Maximum Current Temperature Derating at Sea Level ( $V_{IN} = 12V$ , Transverse Airflow). *No extra ground pads.*

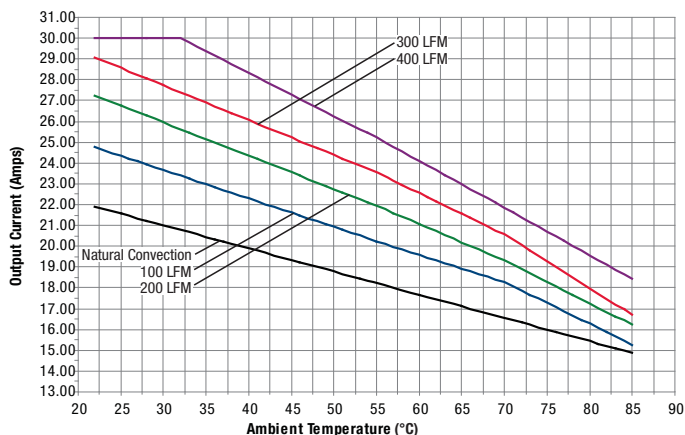

StepLoad Transient Response ( $V_{IN} = 12V$ , 0-15A-0)

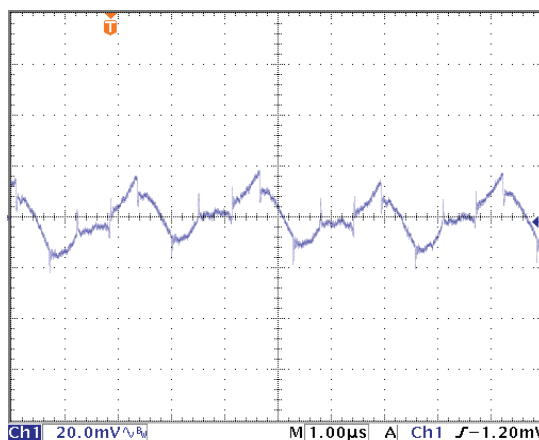

**PERFORMANCE DATA: OUTPUT VOLTAGE = 1.2 VOLTS**

Efficiency vs. Line Voltage and Load Current @ +25°C (VIN = 12V)

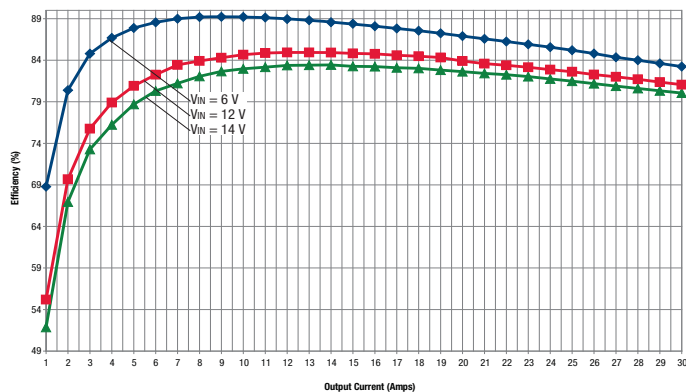

Output Ripple & Noise (VIN = 12 V, IOUT = 30 A, COU = 10µF || 1µF, 'scope BW = 20 MHz)

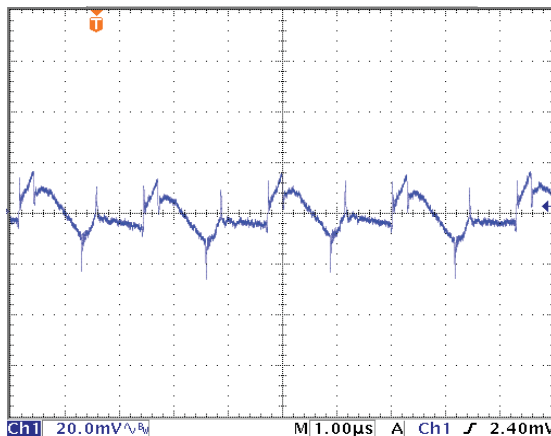

LSM2-T/30-D12R Maximum Current Temperature Derating (VIN = 12V, Transverse Airflow). Extra ground pads installed.

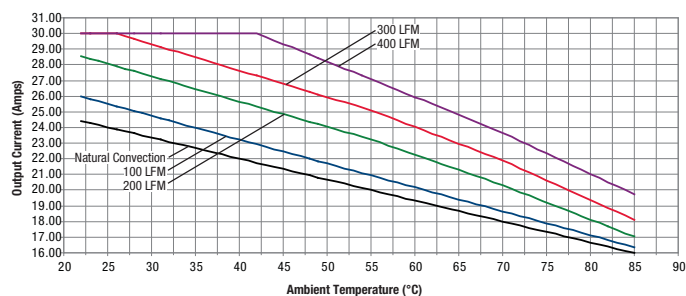

Power-On Startup (VIN = 12 V, IOUT = 30 A)

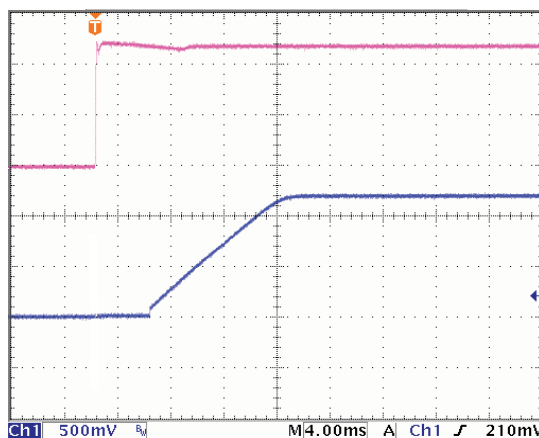

StepLoad Transient Response (VIN = 12 V, 0-15A-0)

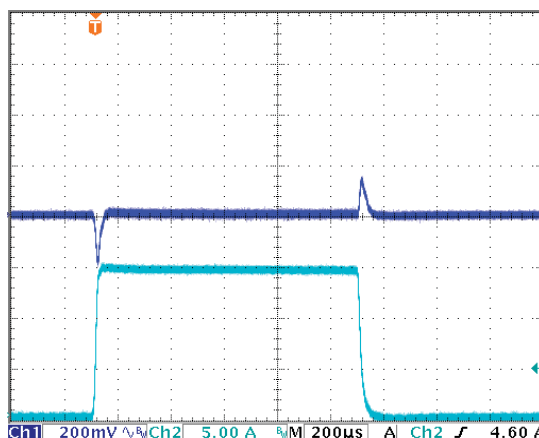

**PERFORMANCE DATA: OUTPUT VOLTAGE = 0.8 VOLTS**

**Efficiency vs. Line Voltage and Load Current @ +25°C (VIN = 12V)**

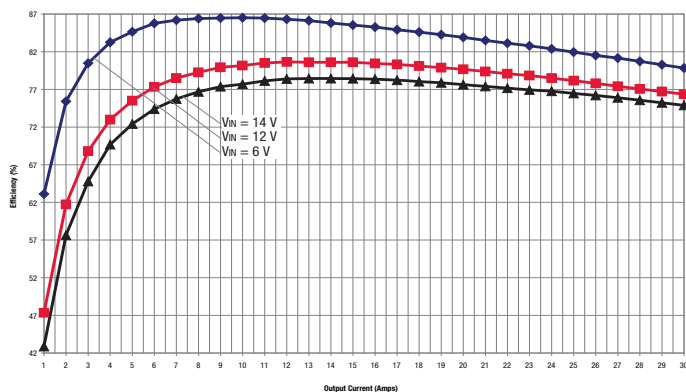

**Output Ripple & Noise (VIN = 12 V, IOUT = 30 A, COUT = 10μF || 1μF, 'scope BW = 20 MHz)**

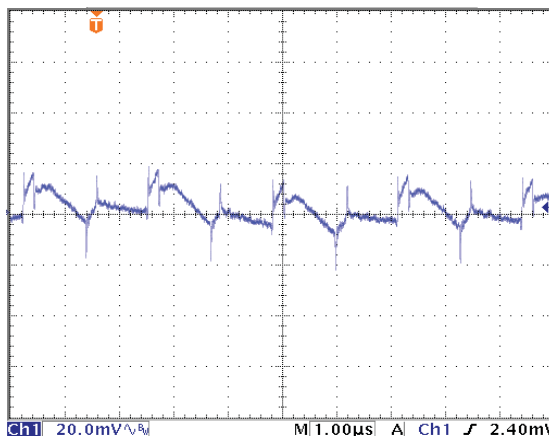

**LSM2-T/30-D12R Maximum Current Temperature Derating (VIN = 12V, Transverse Airflow). Extra ground pads installed.**

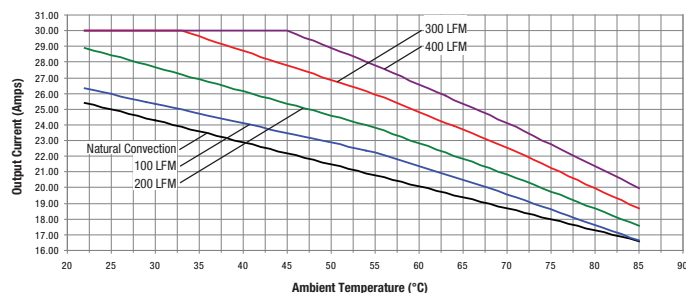

**Power-On Startup (VIN = 12 V, IOUT = 30 A)**

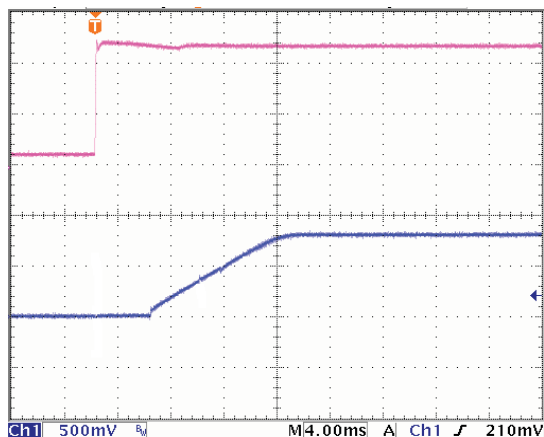

**StepLoad Transient Response (VIN = 12 V, 0-15A-0)**

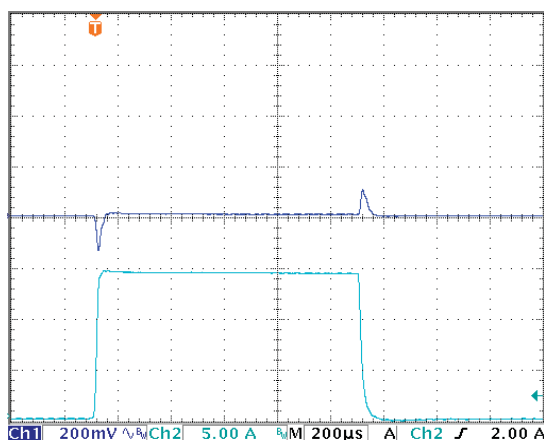

Murata Power Solutions, Inc.  
 11 Cabot Boulevard, Mansfield, MA 02048-1151 U.S.A.  
 ISO 9001 and 14001 REGISTERED

Murata Power Solutions, Inc. makes no representation that the use of its products in the circuits described herein, or the use of other technical information contained herein, will not infringe upon existing or future patent rights. The descriptions contained herein do not imply the granting of licenses to make, use, or sell equipment constructed in accordance therewith. Specifications are subject to change without notice. © 2010 Murata Power Solutions, Inc.

