



Typical unit

PRODUCT OVERVIEW

The OKY-T/10 and -T/16 series are miniature SMT non-isolated Point-of-Load (POL) DC/DC power converters for embedded applications. The module is fully compatible with Distributed-power Open Standards Alliance (DOSA) industry-standard specifications (www.dosapower.com). Applications include powering CPU's, datacom/telecom systems, programmable logic and mixed voltage systems.

The wide input range is 8.3 to 14 Volts DC. Two maximum output currents are offered, 10 Amps (T/10 models) or 16 Amps (T/16 models). Based on fixed-frequency synchronous buck converter switching topology, the high power conversion

efficient Point of Load (POL) module features programmable output voltage and On/Off control. An optional Sequence/Tracking input allows controlled ramp-up and ramp-down outputs. The Sense input provides remote sense. These converters also include under voltage lock out (UVLO), output short circuit protection, over-current and over temperature protections.

These units are designed to meet all standard UL/EN/IEC 60950-1 safety and FCC EMI/RFI emissions certifications and RoHS-6 hazardous substance compliance.

FEATURES

- Wide 8.3-14 VDC input range
- Non-isolated output adjustable from 0.7525 to 5.5 Volts up to 16 Amps
- DOSA-compatible SMT package
- Optional sequence/tracking operation
- Outstanding thermal performance and derating
- Short circuit protection
- On/Off control
- High efficiency up to 94.5%
- Over temperature protection
- Meets UL/EN/IEC 60950-1 safety approvals.

Contents	Page
Description, Connection Diagram, Photograph	1
Ordering Guide, Model Numbering	2
Mechanical Specifications, Input/Output Pinout	3
Detailed Electrical Specifications	4
Output Voltage Adjustment, Soldering Guidelines	5
Application Notes	6
Performance Data – OKY2-T/10-D12	9
Performance Data and Oscillograms – OKY2-T/16-D12	11
Tape and Reel Information	16
Product Label, MTBF Table	17

Simplified Block Diagram

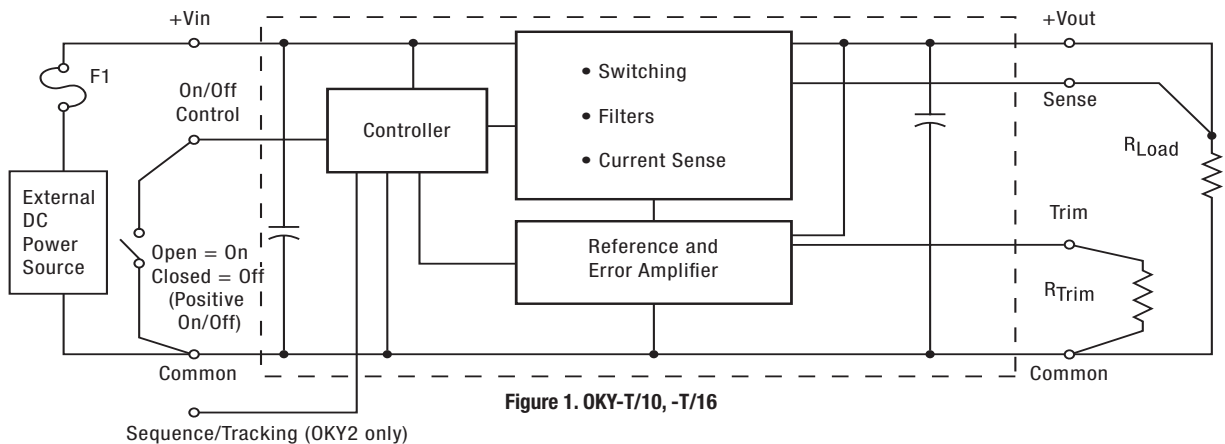

Figure 1. OKY-T/10, -T/16

Note: Murata Power Solutions strongly recommends an external input fuse, F1. See specifications.



Performance Specifications and Ordering Guide

ORDERING GUIDE																
Model Number ③	Output						Input				Efficiency		On/Off Polarity Sequence/Track	Package, C83		
	V _{OUT} (Volts)	I _{OUT} (Amps max)	Power (Watts)	R/N (mVp-p)	Regulation (Max.)		V _{IN} Nom. (Volts)	Range (Volts)	I _{IN} , no load (mA)	I _{IN} , full load (Amps)	Min.	Typ.		Case ①	Pinout	
				Max. ⑤	Line	Load										
OKY-T/10-D12P-C	0.7525-5.5	10	50	40	±0.15%	±0.25%	12	8.3-14	80	4.41	93%	94.5%	Pos.	No	1.3x0.53x0.33 (33x13.5x8.4)	P66
OKY-T/10-D12N-C	0.7525-5.5	10	50	40	±0.15%	±0.25%	12	8.3-14	80	4.41	93%	94.5%	Neg.	No	1.3x0.53x0.33 (33x13.5x8.4)	P66
OKY2-T/10-D12P-C	0.7525-5.5	10	50	40	±0.15%	±0.25%	12	8.3-14	80	4.41	93%	94.5%	Pos.	Yes	1.3x0.53x0.33 (33x13.5x8.4)	P66
OKY2-T/10-D12N-C	0.7525-5.5	10	50	40	±0.15%	±0.25%	12	8.3-14	80	4.41	93%	94.5%	Neg.	Yes	1.3x0.53x0.33 (33x13.5x8.4)	P66
OKY-T/16-D12P-C	0.7525-5.5	16	80	40	±0.22%	±0.25%	12	8.3-14	80	7.09	92.5%	94%	Pos.	No	1.3x0.53x0.33 (33x13.5x8.4)	P66
OKY-T/16-D12N-C	0.7525-5.5	16	80	40	±0.22%	±0.25%	12	8.3-14	80	7.09	92.5%	94%	Neg.	No	1.3x0.53x0.33 (33x13.5x8.4)	P66
OKY2-T/16-D12P-C	0.7525-5.5	16	80	40	±0.22%	±0.25%	12	8.3-14	80	7.09	92.5%	94%	Pos.	Yes	1.3x0.53x0.33 (33x13.5x8.4)	P66
OKY2-T/16-D12N-C	0.7525-5.5	16	80	40	±0.22%	±0.25%	12	8.3-14	80	7.09	92.5%	94%	Neg.	Yes	1.3x0.53x0.33 (33x13.5x8.4)	P66

① Dimensions are in inches (mm).

② The input voltage range must be 13.2 Volts max. for V_{out} >= 3.63 V.

③ All specifications are at nominal line voltage, V_{out}=nominal (5V for D12 models) and full load, +25 deg.C. unless otherwise noted.

Output capacitors are 1 µF ceramic and 10 µF electrolytic in parallel. Input cap is 22 µF. See detailed specifications. I/O caps are necessary for our test equipment and may not be needed for your application.

④ Use adequate ground plane and copper thickness adjacent to the converter.

⑤ Ripple and Noise (R/N) is shown at V_{out}=1V. See specs for details.

PART NUMBER STRUCTURE

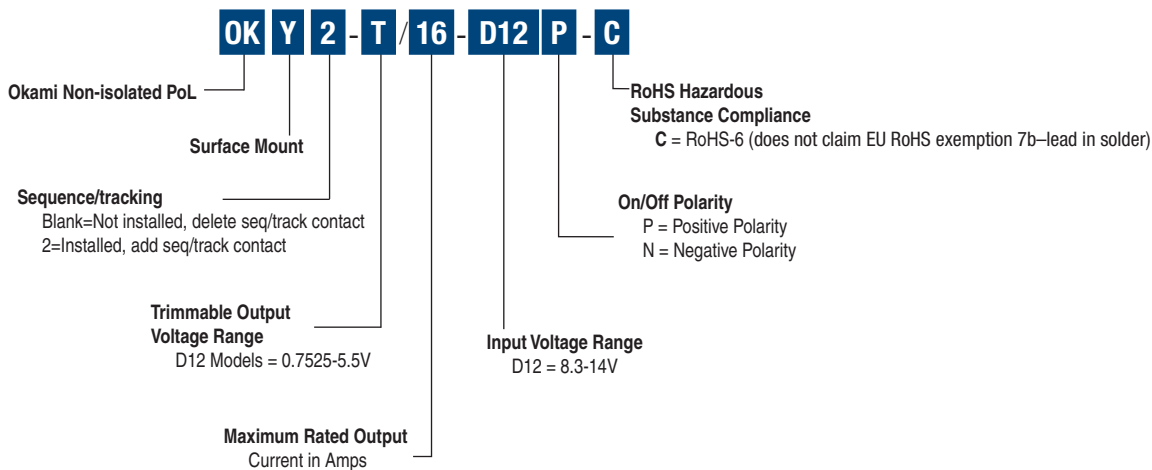

MECHANICAL SPECIFICATIONS

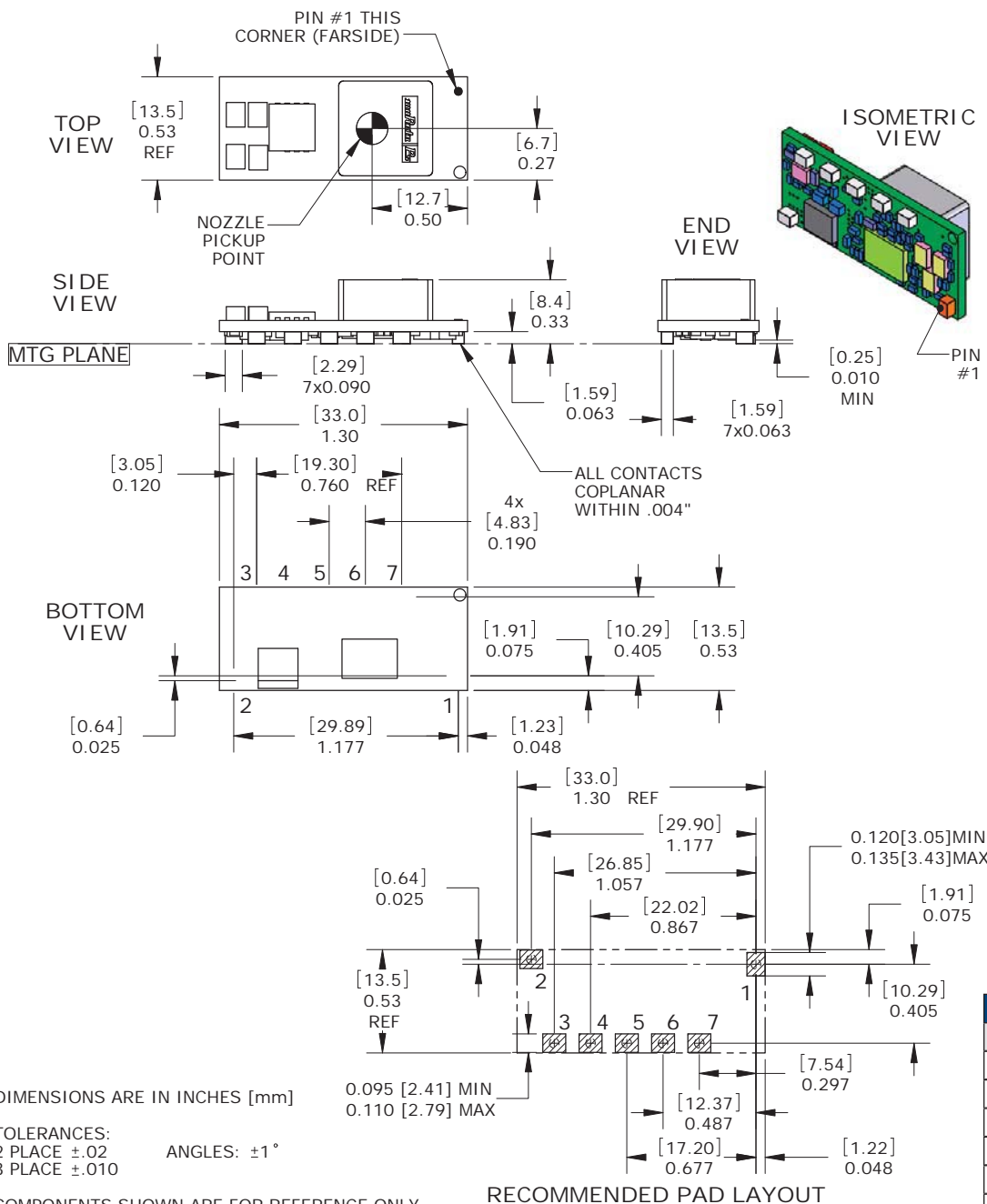

DIMENSIONS ARE IN INCHES [mm]

TOLERANCES:
 2 PLACE ±.02 ANGLES: ±1°
 3 PLACE ±.010

COMPONENTS SHOWN ARE FOR REFERENCE ONLY

MATERIAL:
 SMT PINS: COPPER ALLOY

FINISH: (ALL PINS)
 GOLD (5u"MIN) OVER NICKEL (50u" MIN)

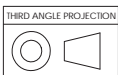

I/O CONNECTIONS	
Pin	Function P66
1	On/Off Control *
2	+Vin
3	Vtrack Seq**
4	Gnd (Common)
5	+Vout
6	Trim
7	Sense

* The Remote On/Off can be provided with either positive (P suffix) or negative (N suffix) polarity.
 ** Vtrack Seq applies only to OKY2 models. No connection for OKY models.

Performance and Functional Specifications

See Note 1

Input	
Input Voltage Range	See Ordering Guide.
Start-Up Voltage	8.00V
Undervoltage Shutdown (see Note 15)	7.75V)
Overvoltage Shutdown	None
Reflected (Back) Ripple Current (Note 2)	20 mA pk-pk
Internal Input Filter Type	Capacitive
Recommended External Fuse	15A (T/10); 20A (T/16)
Reverse Polarity Protection	N/A. See fuse information
Input Current:	
Full Load Conditions	See Ordering Guide
Inrush Transient	0.4 A ² Sec.
Shutdown Mode (Off, UV, OT)	5 mA
Output in Short Circuit	100 mA (T/10); 60 mA (T/16)
No Load	80 mA
Low Line (Vin=Vmin, Vout=Vnom)	6.34 A (T/10); 10.2 A (T/16)
Remote On/Off Control (Note 5)	
Negative Logic ("N" model suffix)	ON = Open pin or ground to +0.3V. max. OFF = +2.5V min. to + Vin (max)
Positive Logic ("P" model suffix)	ON = Open pin to +Vin max. (internally pulled up) OFF = Ground pin to +0.3V. max.
Current	1 mA max.
Tracking/Sequencing	
Slew Rate	2 Volts per millisecond, max.
Tracking accuracy, rising input	Vout = +/-100 mV of Sequence In
Tracking accuracy, falling input	Vout = +/-200 mV of Sequence In
General and Safety	
Efficiency	See Ordering Guide
Switching Frequency	300 KHz ± 25 kHz
Start-Up Time (Vin on to Vout regulated) (On/Off to Vout regulated)	8 mSec for Vout=nominal 8 mSec for Vout=nominal
Isolation	Not isolated
Safety	Meets UL/cUL 60950-1, CSA-C22.2 No. 60950-1, IEC/EN 60950-1
Calculated MTBF	See table on page 17.
Output	
Output Voltage Range	0.7525 to 5.5 V
Minimum Loading	No minimum load
Accuracy (50% load, untrimmed)	±2 % of Vnominal
Overvoltage Protection (Note 16)	None
Temperature Coefficient	±0.02% per oC of Vout range
Ripple/Noise (20 MHz bandwidth)	See Ordering Guide and note 8
Line/Load Regulation	See Ordering Guide and note 10
Maximum Capacitive Loading (Note 14)	
Cap-ESR=0.001 to 0.01 Ohms	1,000 µF
Cap-ESR >0.01 Ohms	5,000 µF
Current Limit Inception (Note 6) (98% of Vout setting, after warm up)	27 Amps (T/10); 33 Amps (T/16)
Short Circuit Mode	
Short Circuit Current Output	2 A
Protection Method	Hiccup autorecovery upon overload removal. (Note 17)

Output, continued	
Short Circuit Duration	Continuous, no damage (output shorted to ground)
Prebias Startup	Converter will start up if the external output voltage is less than Vset
Dynamic Load Response (50-100% load step, di/dt=2.5A/µSec)	75 µSec max. to within ±2% of final value
Environmental	
Operating Temperature Range (Ambient) See derating curves	-40 to +85° C. with derating (Note 9)
Operating PC Board Temperature	-40 to +100° C. max., no derating (12)
Storage Temperature Range	-55 to +125° C.
Thermal Protection/Shutdown	+130° C.
Relative Humidity	to 85%RH/+85° C., non-condensing
Physical	
Outline Dimensions	See Mechanical Specifications
Weight	0.1 ounces (2.8 grams)
Electromagnetic Interference	Designed to meet FCC part 15, class B, EN55022 and CISPR22 class B radiated (may need external filter)
Restriction of Hazardous Substances	RoHS-6 (does not claim EU RoHS exemption 7b-lead in solder)
MSL Rating	2
Absolute Maximum Ratings	
Input Voltage (Continuous or transient) On/Off Control	0 V to +15 Volts max. (D12 models) 0 V. min. to +Vin max.
Input Reverse Polarity Protection	See Fuse section
Output Current (Note 7)	Current-limited. Devices can withstand a sustained short circuit without damage. The outputs are not intended to accept appreciable reverse current.
Storage Temperature	-55 to +125° C.
Lead Temperature	See soldering specifications

Absolute maximums are stress ratings. Exposure of devices to greater than any of any of these conditions may adversely affect long-term reliability. Proper operation under conditions other than those listed in the Performance/Functional Specifications Table is not implied nor recommended.

Specification Notes:

- Specifications are typical at +25 deg.C, Vin=nominal (+12V. for D12 models), Vout=nominal (+5V for D12 models), full load, external caps and natural convection unless otherwise indicated. Extended tests at higher power must supply substantial forced airflow.
All models are tested and specified with external 1 µF paralleled with 10 µF ceramic/tantalum output capacitors and a 22 µF external input capacitor. All capacitors are low ESR types. These capacitors are necessary to accommodate our test equipment and may not be required to achieve specified performance in your applications. However, Murata Power Solutions recommends installation of these capacitors. All models are stable and regulate within spec under no-load conditions.
- Input Back Ripple Current is tested and specified over a 5 Hz to 20 MHz bandwidth. Input filtering is Cin=2 x 100 µF tantalum, Cbus=1000 µF electrolytic, Lbus=1 µH.
- Note that Maximum Power Derating curves indicate an average current at nominal input voltage. At higher temperatures and/or lower airflow, the DC/DC converter will tolerate brief full current outputs if the total RMS current over time does not exceed the Derating curve.
- Deleted

Specification Notes, Cont.:

- (5) The On/Off Control Input should use either a switch or an open collector/open drain transistor referenced to -Input Common. A logic gate may also be used by applying appropriate external voltages which not exceed +Vin.
- (6) Short circuit shutdown begins when the output voltage degrades approximately 2% from the selected setting.
- (7) Deleted.
- (8) Output noise may be further reduced by adding an external filter. At zero output current, the output may contain low frequency components which exceed the ripple specification. The output may be operated indefinitely with no load.
- (9) All models are fully operational and meet published specifications, including "cold start" at -40°C.
- (10) Regulation specifications describe the deviation as the line input voltage or output load current is varied from a nominal midpoint value to either extreme.
- (11) Other input or output voltage ranges will be reviewed under scheduled quantity special order.
- (12) Maximum PC board temperature is measured with the sensor in the center of the converter.
- (13) Do not exceed maximum power specifications when adjusting the output trim.
- (14) The maximum output capacitive loads depend on the the Equivalent Series Resistance (ESR) of the external output capacitor and, to a lesser extent, the distance and series impedance to the load. Larger caps will reduce output noise but may change the transient response. Newer ceramic caps with very low ESR may require lower capacitor values to avoid instability. Thoroughly test your capacitors in the application. Please refer to the Output Capacitive Load Application Note.
- (15) Do not allow the input voltage to degrade lower than the input undervoltage shutdown voltage at all times. Otherwise, you risk having the converter turn off. The undervoltage shutdown is not latching and will attempt to recover when the input is brought back into normal operating range.
- (16) The output is not intended to sink appreciable reverse current.
- (17) "Hiccup" overcurrent operation repeatedly attempts to restart the converter with a brief, full-current output. If the overcurrent condition still exists, the restart current will be removed and then tried again. This short current pulse prevents overheating and damaging the converter. Once the fault is removed, the converter immediately recovers normal operation.

Output Voltage Adjustment

The output voltage may be adjusted over a limited range by connecting an external trim resistor (Rtrim) between the Trim pin and Ground. The Rtrim resistor must be a 1/10 Watt precision metal film type, ±1% accuracy or better with low temperature coefficient, ±100 ppm/°C. or better. Mount the resistor close to the converter with very short leads or use a surface mount trim resistor.

In the tables opposite, the calculated resistance is given. Do not exceed the specified limits of the output voltage or the converter's maximum power rating when applying these resistors. Also, avoid high noise at the Trim input. However, to prevent instability, you should never connect any capacitors to Trim.

OKY2-T/10-D12, -T/16-D12

Output Voltage	Calculated Rtrim (KΩ)
5.0 V.	1.472
3.3 V.	3.122
2.5 V.	5.009
2.0 V.	7.416
1.8 V.	9.024
1.5 V.	13.05
1.2 V.	22.46
1.0 V.	41.424
0.7525 V.	∞ (open)

Resistor Trim Equation, D12 models:

$$R_{TRIM} (\Omega) = \frac{10500}{V_{OUT} - 0.7525V} - 1000$$

Soldering Guidelines

Murata Power Solutions recommends the specifications below when installing these converters. These specifications vary depending on the solder type. Exceeding these specifications may cause damage to the product. Your production environment may differ therefore please thoroughly review these guidelines with your process engineers.

Reflow Solder Operations for surface-mount products (SMT)	
For Sn/Ag/Cu based solders:	
Preheat Temperature	Less than 1 °C. per second
Time over Liquidus	45 to 75 seconds
Maximum Peak Temperature	260 °C.
Cooling Rate	Less than 3 °C. per second
For Sn/Pb based solders:	
Preheat Temperature	Less than 1 °C. per second
Time over Liquidus	60 to 75 seconds
Maximum Peak Temperature	235 °C.
Cooling Rate	Less than 3 °C. per second

Recommended Lead-free Solder Reflow Profile

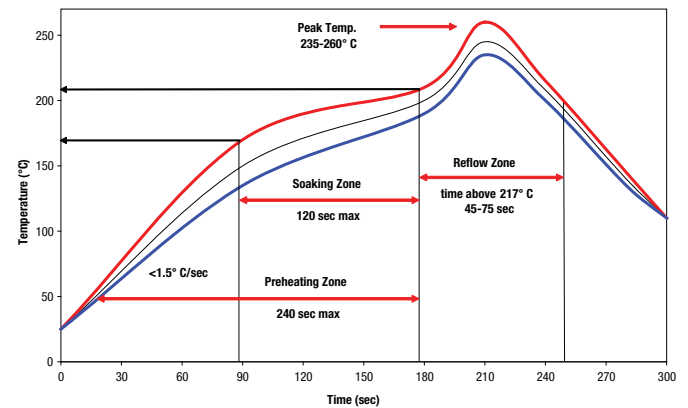

High trace = normal upper limit

Low trace - normal lower limit

APPLICATION NOTES

Input Fusing

Certain applications and/or safety agencies may require fuses at the inputs of power conversion components. Fuses should also be used when there is the possibility of sustained input voltage reversal which is not current-limited. We recommend a time delay fuse installed in the ungrounded input supply line with a value which is approximately twice the maximum line current, calculated at the lowest input voltage. Please refer to the Specifications.

The installer must observe all relevant safety standards and regulations. For safety agency approvals, install the converter in compliance with the end-user safety standard, i.e. IEC/EN/UL 60950-1.

Input Under-Voltage Shutdown and Start-Up Threshold

Under normal start-up conditions, converters will not begin to regulate properly until the ramping-up input voltage exceeds and remains at the Start-Up Threshold Voltage (see Specifications). Once operating, converters will not turn off until the input voltage drops below the Under-Voltage Shutdown Limit. Subsequent restart will not occur until the input voltage rises again above the Start-Up Threshold. This built-in hysteresis prevents any unstable on/off operation at a single input voltage.

Users should be aware however of input sources near the Under-Voltage Shutdown whose voltage decays as input current is consumed (such as poorly regulated capacitor inputs), the converter shuts off and then restarts as the external capacitor recharges. Such situations could oscillate. To prevent this, make sure the operating input voltage is well above the UV Shutdown voltage AT ALL TIMES.

Start-Up Time

Assuming that the output current is set at the rated maximum, the Vin to Vout Start-Up Time (see Specifications) is the time interval between the point when the ramping input voltage crosses the Start-Up Threshold and the fully loaded regulated output voltage enters and remains within its specified regulation band. Actual measured times will vary with input source impedance, external input capacitance, input voltage slew rate and final value of the input voltage as it appears at the converter.

These converters include a soft start circuit to moderate the duty cycle of its PWM controller at power up, thereby limiting the input inrush current.

The On/Off Remote Control interval from On command to Vout regulated assumes that the converter already has its input voltage stabilized above the Start-Up Threshold before the On command. The interval is measured from the On command until the output enters and remains within its specified accuracy band. The specification assumes that the output is fully loaded at maximum rated current. Similar conditions apply to the On to Vout regulated specification such as external load capacitance and soft start circuitry.

Recommended Input Filtering

The user must assure that the input source has low AC impedance to provide dynamic stability and that the input supply has little or no inductive content, including long distributed wiring to a remote power supply. The converter will operate with no additional external capacitance if these conditions are met.

For best performance, we recommend installing a low-ESR capacitor immediately adjacent to the converter's input terminals. The capacitor should be a ceramic type such as the Murata GRM32 series or a polymer type. Initial

suggested capacitor values are 10 to 22 μF , rated at twice the expected maximum input voltage. Make sure that the input terminals do not go below the undervoltage shutdown voltage at all times. More input bulk capacitance may be added in parallel (either electrolytic or tantalum) if needed.

Recommended Output Filtering

The converter will achieve its rated output ripple and noise with no additional external capacitor. However, the user may install more external output capacitance to reduce the ripple even further or for improved dynamic response. Again, use low-ESR ceramic (Murata GRM32 series) or polymer capacitors. Initial values of 10 to 47 μF may be tried, either single or multiple capacitors in parallel. Mount these close to the converter. Measure the output ripple under your load conditions.

Use only as much capacitance as required to achieve your ripple and noise objectives. Excessive capacitance can make step load recovery sluggish or possibly introduce instability. Do not exceed the maximum rated output capacitance listed in the specifications.

Input Ripple Current and Output Noise

All models in this converter series are tested and specified for input reflected ripple current and output noise using designated external input/output components, circuits and layout as shown in the figures below. The Cbus and Lbus components simulate a typical DC voltage bus. Please note that the values of Cin, Lbus and Cbus may vary according to the specific converter model.

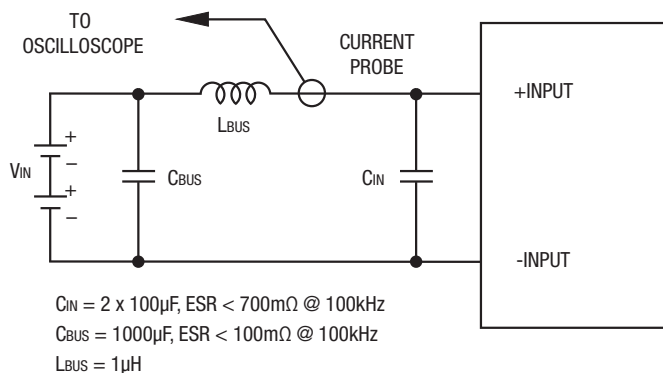

Figure 2: Measuring Input Ripple Current

In figure 3, the two copper strips simulate real-world printed circuit impedances between the power supply and its load. In order to minimize circuit errors and standardize tests between units, scope measurements should be made using BNC connectors or the probe ground should not exceed one half inch and soldered directly to the test circuit.

Minimum Output Loading Requirements

All models regulate within specification and are stable under no load to full load conditions. Operation under no load might however slightly increase output ripple and noise.

Thermal Shutdown

To prevent many over temperature problems and damage, these converters include thermal shutdown circuitry. If environmental conditions cause the temperature of the DC/DC's to rise above the Operating Temperature Range

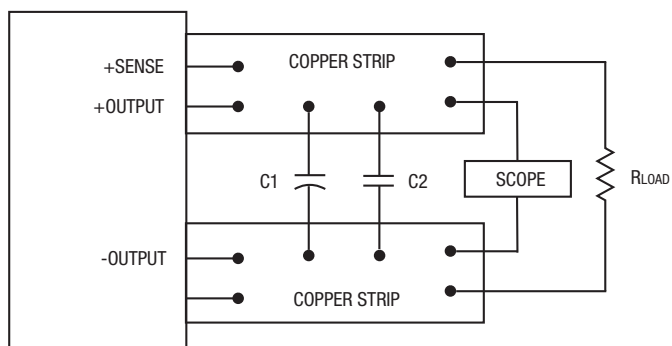

C1 = 0.1µF CERAMIC
 C2 = 10µF TANTALUM
 LOAD 2-3 INCHES (51-76mm) FROM MODULE

Figure 3: Measuring Output Ripple and Noise (PARD)

up to the shutdown temperature, an on-board electronic temperature sensor will power down the unit. When the temperature decreases below the turn-on threshold, the converter will automatically restart. There is a small amount of temperature hysteresis to prevent rapid on/off cycling.

CAUTION: If you operate too close to the thermal limits, the converter may shut down suddenly without warning. Be sure to thoroughly test your application to avoid unplanned thermal shutdown.

Temperature Derating Curves

The graphs in the next section illustrate typical operation under a variety of conditions. The Derating curves show the maximum continuous ambient air temperature and decreasing maximum output current which is acceptable under increasing forced airflow measured in Linear Feet per Minute (“LFM”). Note that these are AVERAGE measurements. The converter will accept brief increases in current or reduced airflow as long as the average is not exceeded.

Note that the temperatures are of the ambient airflow, not the converter itself which is obviously running at higher temperature than the outside air. Also note that very low flow rates (below about 25 LFM) are similar to “natural convection”, that is, not using fan-forced airflow.

Murata Power Solutions makes Characterization measurements in a closed cycle wind tunnel with calibrated airflow. We use both thermocouples and an infrared camera system to observe thermal performance.

CAUTION: If you routinely or accidentally exceed these Derating guidelines, the converter may have an unplanned Over Temperature shut down. Also, these graphs are all collected at slightly above Sea Level altitude. Be sure to reduce the derating for higher density altitude.

Output Current Limiting

Current limiting inception is defined as the point at which full power falls below the rated tolerance. See the Performance/Functional Specifications. Note particularly that the output current may briefly rise above its rated value in normal operation as long as the average output power is not exceeded. This enhances reliability and continued operation of your application. If the output current is too high, the converter will enter the short circuit condition.

Output Short Circuit Condition

When a converter is in current-limit mode, the output voltage will drop as the output current demand increases. If the output voltage drops too low (approximately 98% of nominal output voltage for most models), the PWM controller will shut down. Following a time-out period, the PWM will restart, causing the output voltage to begin ramping up to its appropriate value. If the short-circuit condition persists, another shutdown cycle will initiate. This rapid on/off cycling is called “hiccup mode”. The hiccup cycling reduces the average output current, thereby preventing excessive internal temperatures and/or component damage. A short circuit can be tolerated indefinitely.

Remote Sense Input

The Sense input is normally connected at the load for the respective Sense polarity (+Sense to the +Vout load). The sense input compensates for voltage drops along the output wiring such as moderate IR drops and the current carrying capacity of PC board etch. This output drop (the difference between Sense and Vout when measured at the converter) should not exceed 0.5V. Use heavier connections if this drop is excessive. The sense input also improves the stability of the converter and load system by optimizing the control loop phase margin.

If the Sense function is not used for remote regulation, the user should connect the Sense to their respective Vout at the converter pins.

Sense lines on the PCB should run adjacent to DC signals, preferably Ground. Any long, distributed wiring and/or significant inductance introduced into the Sense control loop can adversely affect overall system stability. If in doubt, test your applications by observing the converter’s output transient response during step loads. There should not be any appreciable ringing or oscillation.

Do not exceed maximum power ratings. Excessive voltage differences between Vout and Sense together with trim adjustment of the output can cause the overvoltage protection circuit to activate and shut down the output.

Power derating of the converter is based on the combination of maximum output current and the highest output voltage at the output pins. Therefore the designer must insure:

$$(V_{out \text{ at pins}}) \times (I_{out}) \leq (\text{Max. rated output power})$$

Remote On/Off Control

The remote On/Off Control can be ordered with either polarity. Please refer to the Connection Diagram on page 1 for On/Off connections.

Positive polarity models are enabled when the On/Off pin is left open or is pulled high to +Vin with respect to –Vin. Therefore, the On/Off control can be disconnected if the converter should always be on. Positive-polarity devices are disabled when the On/Off is grounded or brought to within a low voltage (see Specifications) with respect to –Vin.

Negative polarity devices are on (enabled) when the On/Off pin is left open or brought to within a low voltage (see Specifications) with respect to –Vin. The device is off (disabled) when the On/Off is pulled high (see Specifications) with respect to –Vin.

Dynamic control of the On/Off function must sink appropriate signal current when brought low and withstand appropriate voltage when brought high. Be aware too that there is a finite time in milliseconds (see Specifications) between the time of On/Off Control activation and stable, regulated output. This time will vary slightly with output load type and current and input conditions.

Output Capacitive Load

These converters do not require external capacitance added to achieve rated specifications. Users should only consider adding capacitance to reduce switching noise and/or to handle spike current load steps. Install only enough capacitance to achieve your noise and surge response objectives. Excess external capacitance may cause regulation problems and possible oscillation or instability. Proper wiring of the Sense inputs will improve these factors under capacitive load.

The maximum rated output capacitance and ESR specification is given for a capacitor installed immediately adjacent to the converter. Any extended output wiring, smaller wire gauge or less ground plane may tolerate somewhat higher capacitance. Also, capacitors with higher ESR may use a larger capacitance.

Sequence/Tracking Input (Optional)

After external input power is applied and the converter stabilizes, a high impedance Sequence/Tracking input pin accepts an external analog voltage referred to -Vin. The output power voltage will then track this Sequence/Tracking input at a one-to-one ratio up to the nominal set point voltage for that converter. This Sequencing input may be ramped, delayed, stepped or otherwise phased as needed for the output power, all fully controlled by the user's external circuits. As a direct input to the converter's feedback loop, response to the Sequence/Tracking input is very fast (milliseconds).

Operation

To use the Sequence/Tracking pin after power start-up stabilizes, apply a rising external voltage to the Sequence/Tracking input. As the voltage rises, the output voltage will track the Sequence/Tracking input (gain = 1). The output voltage will stop rising when it reaches the normal set point for the converter. The Sequence/Tracking input may optionally continue to rise without any effect on the output. Keep the Sequence/Tracking input voltage below the converter's input supply voltage.

Use a similar strategy on power down. The output voltage will stay constant until the Sequence/Tracking input falls below the set point.

Guidelines for Sequence/Tracking Applications

[1] Leave the converter's On/Off Enable control in the On setting. Normally, you should just leave the On/Off pin open.

[2] Allow the converter to stabilize (typically less than 20 mS after +Vin power on) before raising the Sequence/Tracking input. Also, if you wish to have a ramped power down, leave +Vin powered all during the down ramp. Do not simply shut off power.

[3] If you do not plan to use the Sequence/Tracking pin, leave it open.

[4] Observe the Output slew rate relative to the Sequence/Tracking input. A rough guide is 2 Volts per millisecond maximum slew rate. If you exceed this slew rate on the Sequence/Tracking pin, the converter will simply ramp up at it's maximum output slew rate (and will not necessarily track the faster Sequence/Tracking input).

The reason to carefully consider the slew rate limitation is in case you want two different POL's to precisely track each other.

[5] Be aware of the input characteristics of the Sequence/Tracking pin. The high input impedance affects the time constant of any small external ramp capacitor. And the bias current will slowly charge up any external caps over time if they are not grounded.

[6] Allow the converter to eventually achieve its full rated setpoint output voltage. Do not remain in ramp up/down mode indefinitely. The converter is characterized and meets all its specifications only at the setpoint voltage (plus or minus any trim voltage).

[7] The Sequence/Tracking is a sensitive input into the feedback control loop of the converter. Avoid noise and long leads on this input. Keep all wiring very short. Use shielding if necessary.

Pre-Biased Startup

Some sections have external power already partially applied (possibly because of earlier power sequencing) before POL power up. Or leakage power is present so that the DC/DC converter must power up into an existing output voltage. This power may either be stored in an external bypass capacitor or supplied by an active source. These converters include a pre-bias startup mode to prevent initialization problems.

This "pre-biased" condition can also occur with some types of programmable logic or because of blocking diode leakage or small currents passed through forward biased ESD diodes. This feature is variously called "monotonic" because the voltage does not decay or produce a negative transient once the input power is applied and startup begins.

Sequence/Tracking operation is not available during pre-bias startup.

PERFORMANCE DATA – OKY2-T/10-D12

OKY2-T/10-D12 Efficiency vs. Line Voltage and Load Current @ +25°C
(V_{OUT} = 0.7525V)

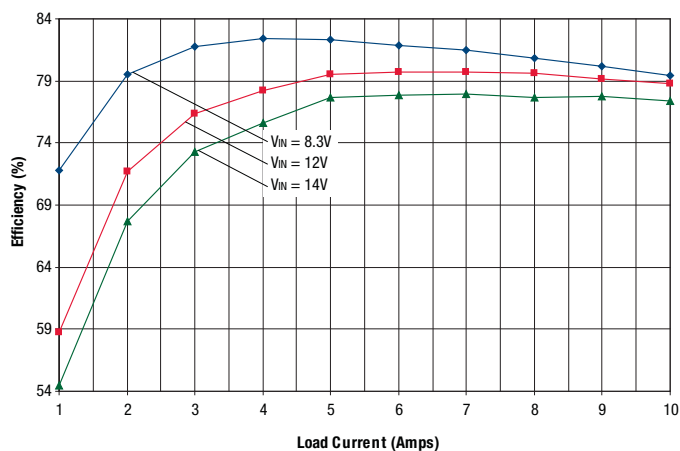

OKY2-T/10-D12 Efficiency vs. Line Voltage and Load Current @ +25°C
(V_{OUT} = 1V)

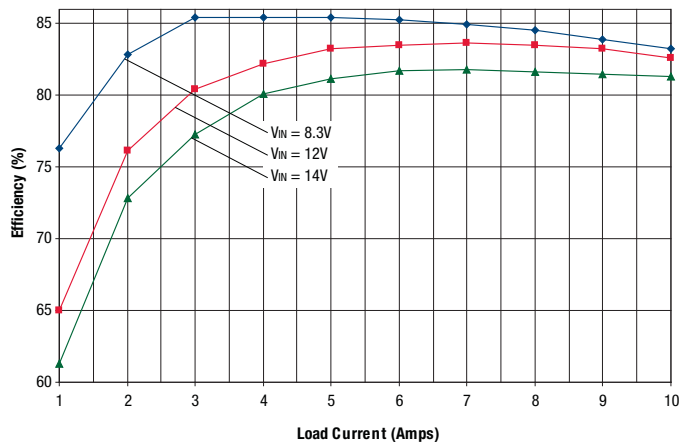

OKY2-T/10-D12 Efficiency vs. Line Voltage and Load Current @ +25°C
(V_{OUT} = 1.2)

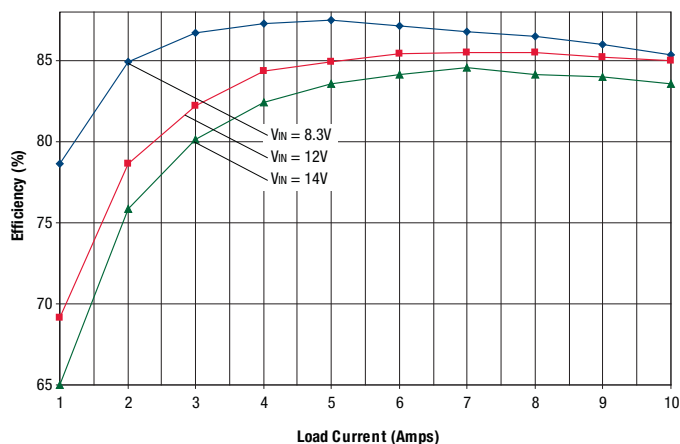

OKY2-T/10-D12 Efficiency vs. Line Voltage and Load Current @ +25°C
(V_{OUT} = 1.5V)

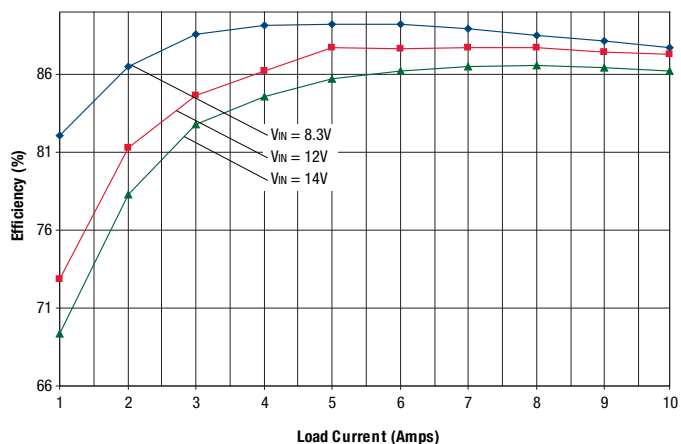

OKY2-T/10-D12 Efficiency vs. Line Voltage and Load Current @ +25°C
(V_{OUT} = 1.8)

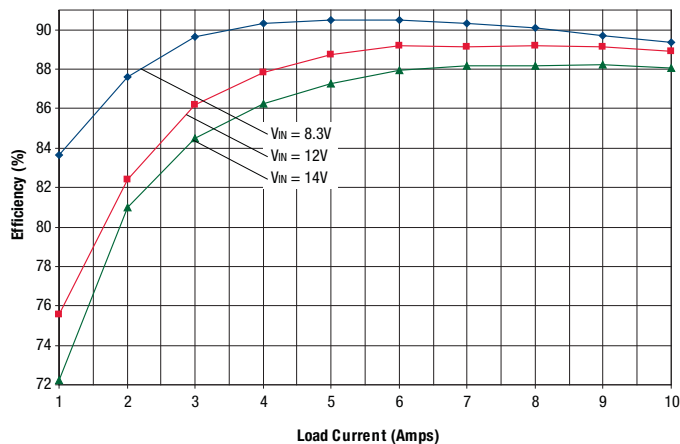

OKY2-T/10-D12 Efficiency vs. Line Voltage and Load Current @ +25°C
(V_{OUT} = 2.5V)

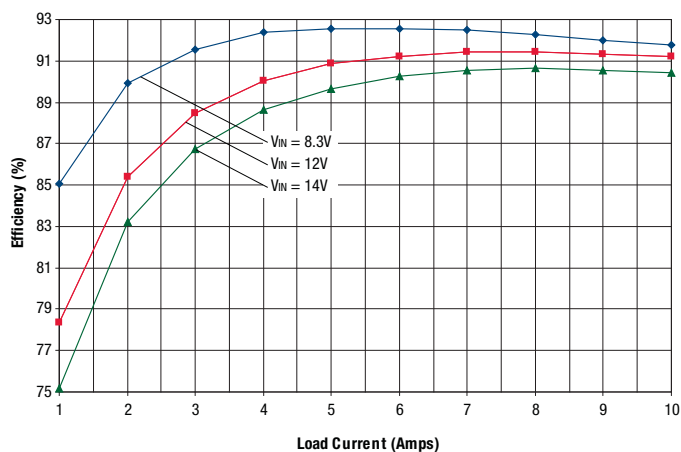

PERFORMANCE DATA – OKY2-T/10-D12

OKY2-T/10-D12 Efficiency vs. Line Voltage and Load Current @ +25°C
(V_{OUT} = 3.3V)

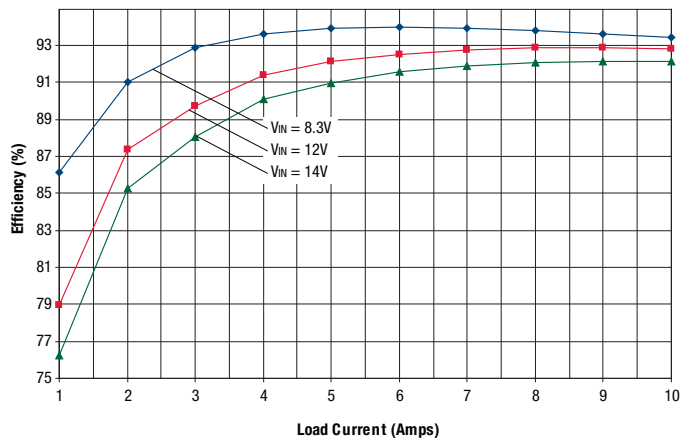

OKY2-T/10-D12 Efficiency vs. Line Voltage and Load Current @ +25°C
(V_{OUT} = 5V)

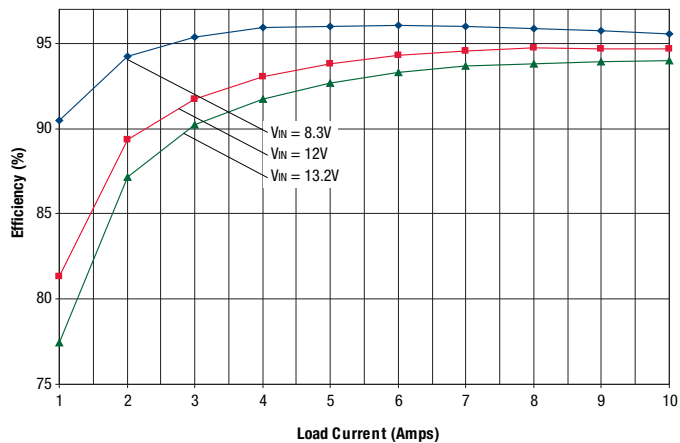

OKY2-T/10-D12-C Maximum Current Temperature Derating at Sea Level
(V_{IN} = 12V, V_{OUT} = 0.75 to 5V).

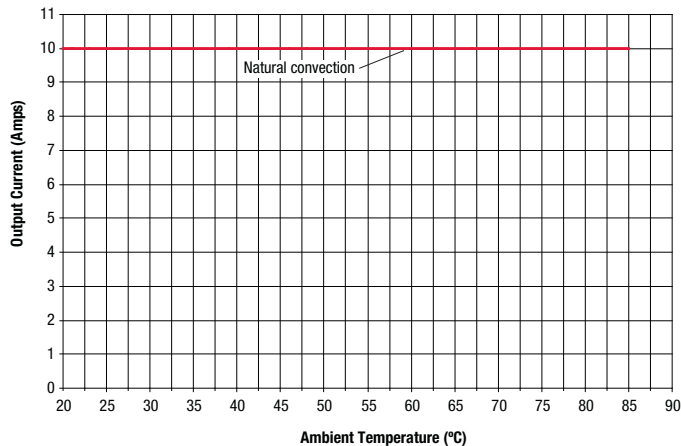

PERFORMANCE DATA AND OSCILLOGRAMS – OKY2-T/16-D12

OKY2-T/16-D12 Efficiency vs. Line Voltage and Load Current @ +25°C
(V_{OUT} = 0.7525V)

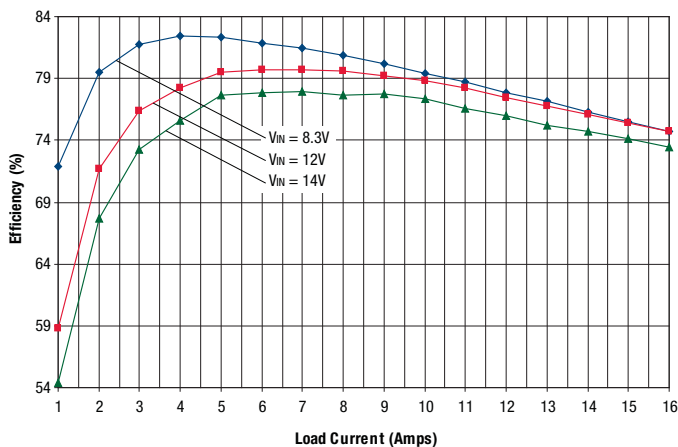

OKY2-T/16-D12-C Maximum Current Temperature Derating at Sea Level
(V_{IN} = 12V, V_{OUT} = 0.75V).

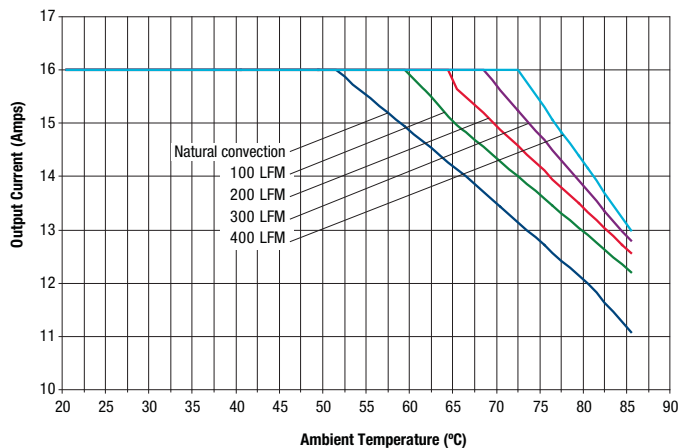

OKY2-T/16-D12 Efficiency vs. Line Voltage and Load Current @ +25°C
(V_{OUT} = 1V)

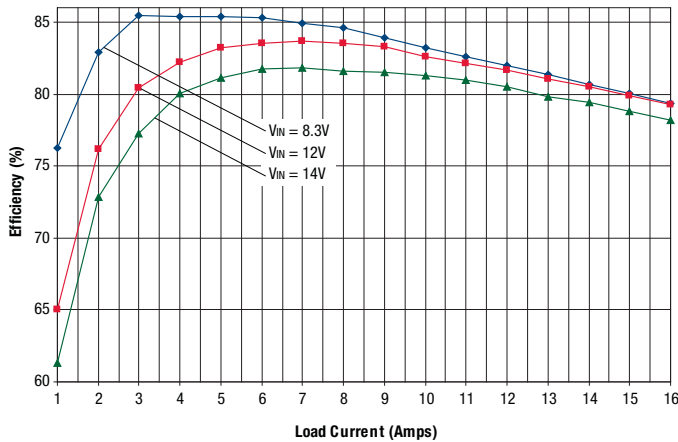

OKY2-T/16-D12 Efficiency vs. Line Voltage and Load Current @ +25°C
(V_{OUT} = 1.2)

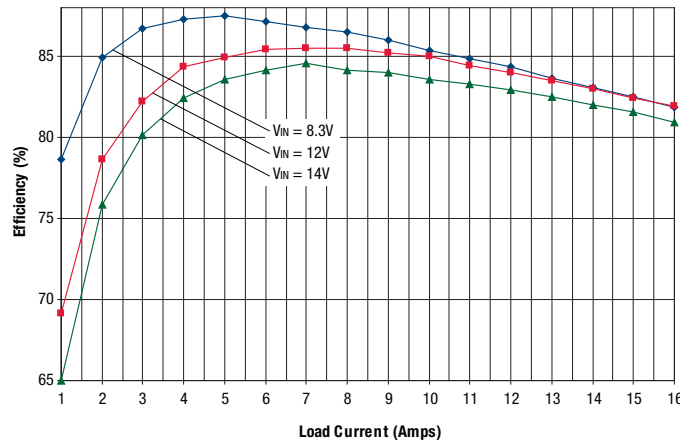

OKY2-T/16-D12 Efficiency vs. Line Voltage and Load Current @ +25°C
(V_{OUT} = 1.5V)

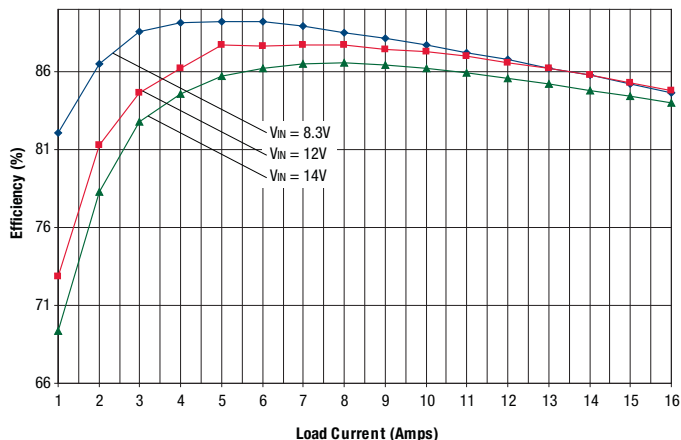

PERFORMANCE DATA AND OSCILLOGRAMS – OKY2-T/16-D12

On/Off Enable Startup Delay (Vin=8.3V, Vout=1.5V, Iout=16A, Cload=0)
Trace 4=Enable In, Trace2=Vout

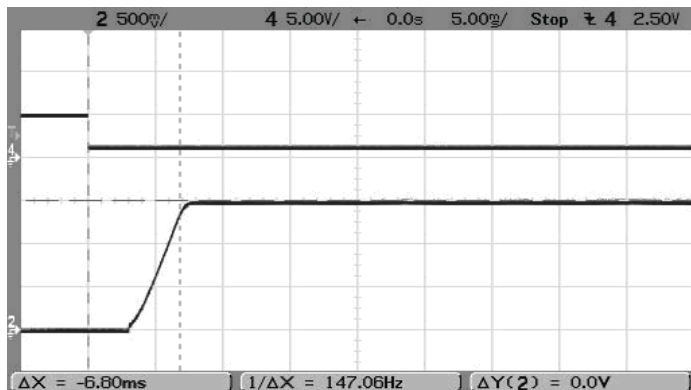

Output Ripple and Noise (Vin=12V, Vout=1.5V, Iout=16A, Cload=0, ScopeBW=100MHz)

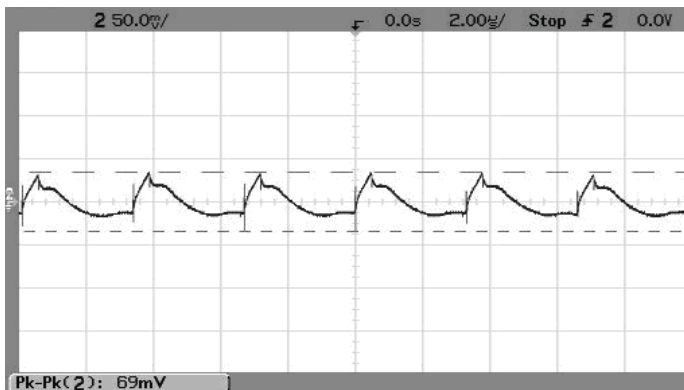

Step Load Transient Response (Vin=12V, Vout=1.5V, Cload=0, Iout=8A to 16A)
Trace 2=Vout, 100 mV/div., Trace4=Iout, 5A/div.

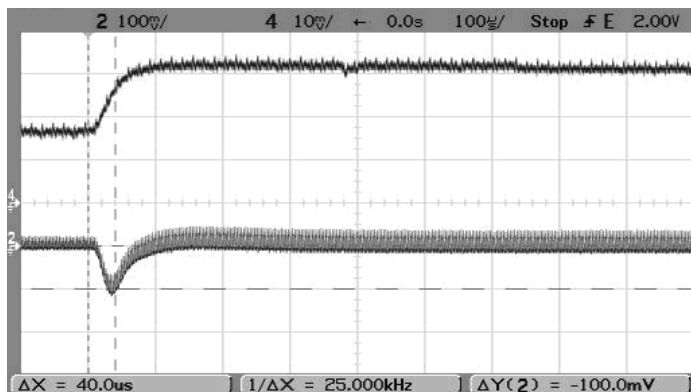

Step Load Transient Response (Vin=12V, Vout=1.5V, Cload=0, Iout=16A to 8A)
Trace 2=Vout, 100 mV/div., Trace4=Iout, 5A/div.

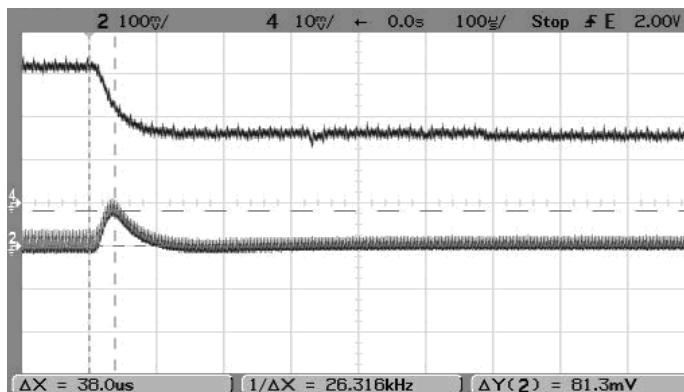

OKY2-T/16-D12 Efficiency vs. Line Voltage and Load Current @ +25°C
(Vout = 1.8)

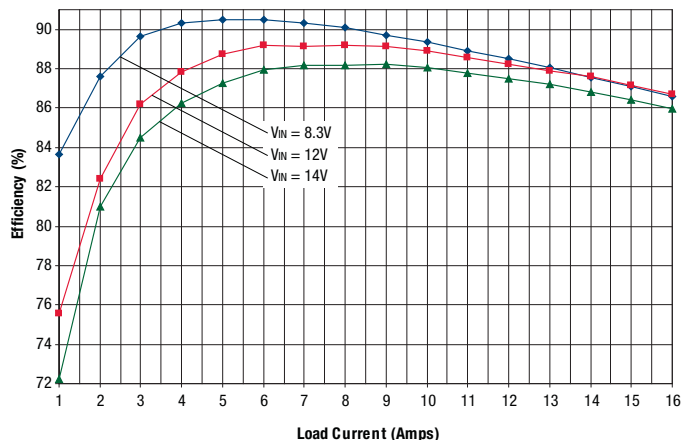

OKY2-T/16-D12-C Maximum Current Temperature Derating at Sea Level
(Vin = 12V, Vout = 1.8V).

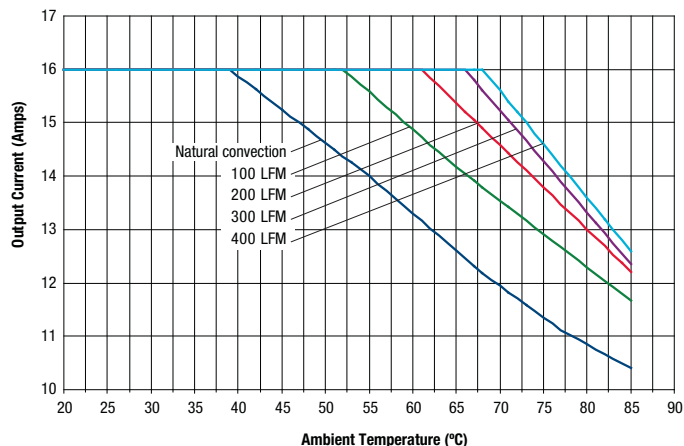

In this graphic data, 10 Amp models perform identically to 16 Amp models with the limitation of 10 Amps output.

PERFORMANCE DATA AND OSCILLOGRAMS – OKY2-T/16-D12

OKY2-T/16-D12 Efficiency vs. Line Voltage and Load Current @ +25°C
(V_{OUT} = 2.5V)

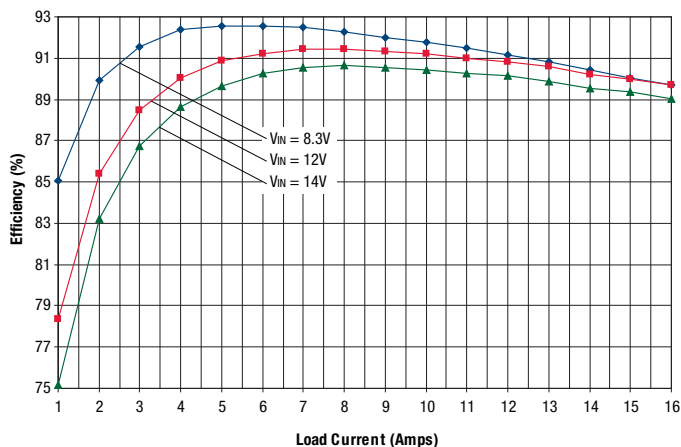

On/Off Enable Startup Delay (V_{IN}=8.3V, V_{OUT}=2.5V, I_{OUT}=16A, C_{LOAD}=0)
Trace 4=Enable In, Trace2=V_{OUT}

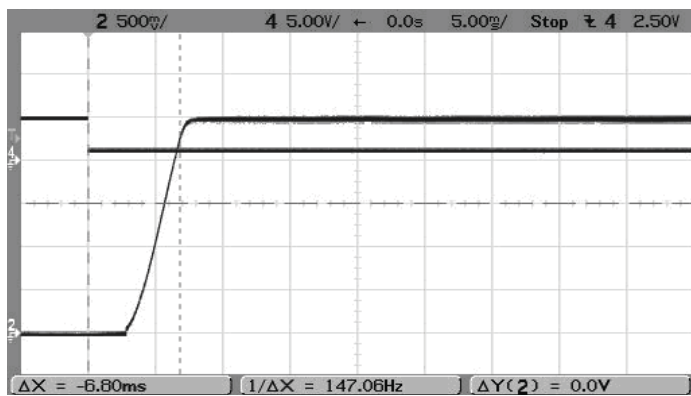

Output Ripple and Noise (V_{IN}=12V, V_{OUT}=2.5V, I_{OUT}=16A, C_{LOAD}=0, ScopeBW=100MHz)

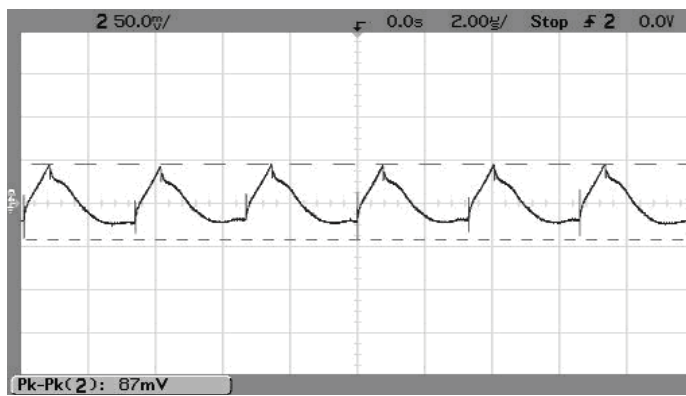

Step Load Transient Response (V_{IN}=12V, V_{OUT}=2.5V, C_{LOAD}=0, I_{OUT}=8A to 16A)
Trace 2=V_{OUT}, 100 mV/div., Trace4=I_{OUT}, 5A/div.

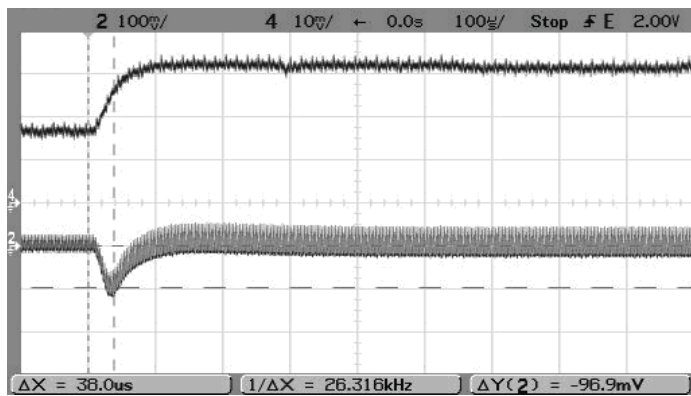

Step Load Transient Response (V_{IN}=12V, V_{OUT}=2.5V, C_{LOAD}=0, I_{OUT}=16A to 8A)
Trace 2=V_{OUT}, 100 mV/div., Trace4=I_{OUT}, 5A/div.

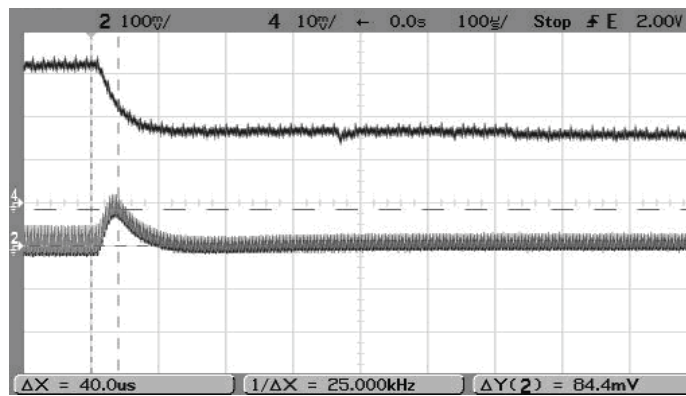

PERFORMANCE DATA AND OSCILLOGRAMS – OKY2-T/16-D12

OKY2-T/16-D12 Efficiency vs. Line Voltage and Load Current @ +25°C
(V_{OUT} = 3.3V)

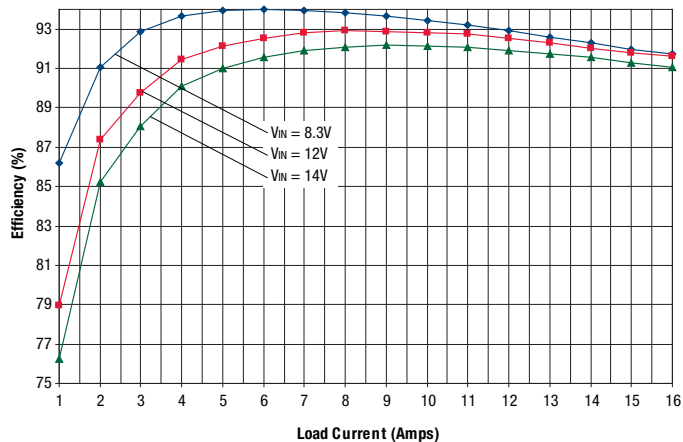

OKY2-T/16-D12-C Maximum Current Temperature Derating at Sea Level
(V_{IN} = 12V, V_{OUT} = 3.3V).

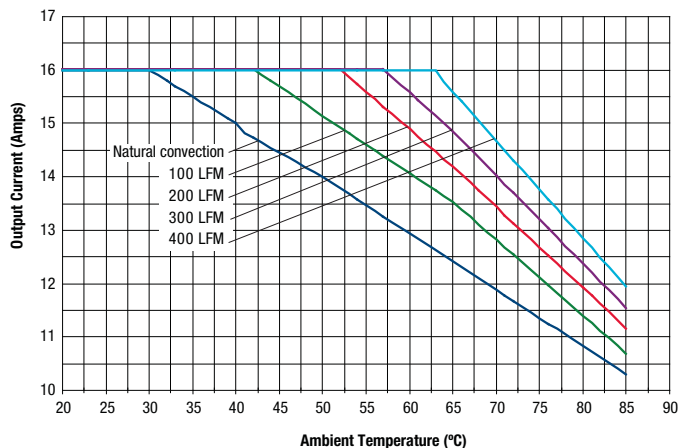

On/Off Enable Startup Delay (Vin=8.3V, Vout=3.3V, Iout=16A, Cload=0)
Trace 4=Enable In, Trace2=Vout

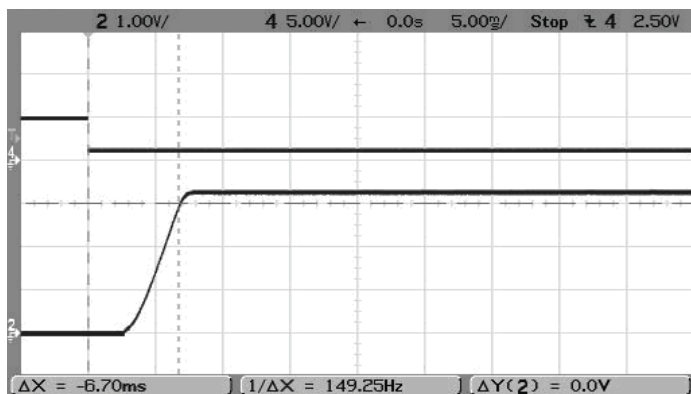

Output Ripple and Noise (Vin=12V, Vout=3.3V, Iout=16A, Cload=0, ScopeBW=100MHz)



Step Load Transient Response (Vin=12V, Vout=3.3V, Cload=0, Iout=8A to 16A)
Trace 2=Vout, 100 mV/div., Trace4=Iout, 5A/div.

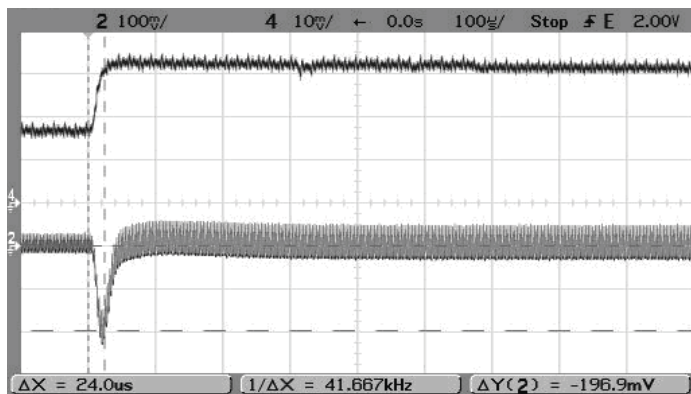

Step Load Transient Response (Vin=12V, Vout=3.3V, Cload=0, Iout=16A to 8A)
Trace 2=Vout, 100 mV/div., Trace4=Iout, 5A/div.

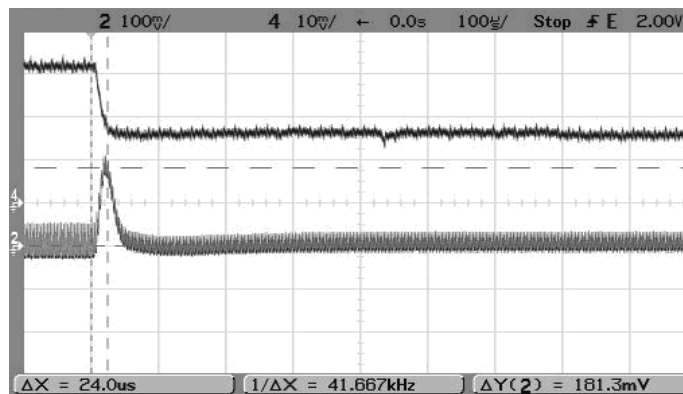

PERFORMANCE DATA AND OSCILLOGRAMS – OKY2-T/16-D12

OKY2-T/16-D12 Efficiency vs. Line Voltage and Load Current @ +25°C
(V_{OUT} = 5V)

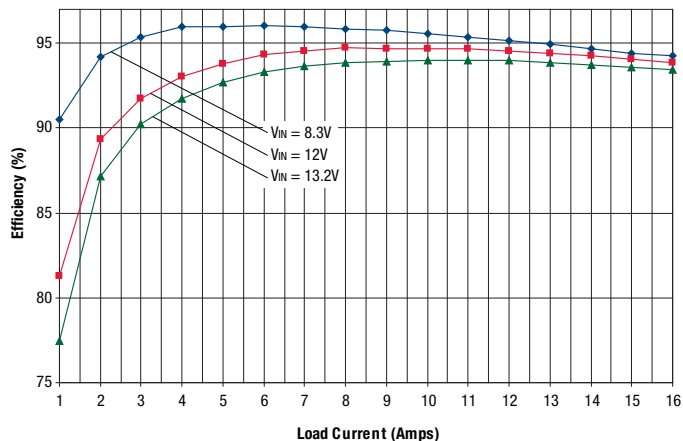

OKY2-T/16-D12-C Maximum Current Temperature Derating at Sea Level
(V_{IN} = 12V, V_{OUT} = 5V)

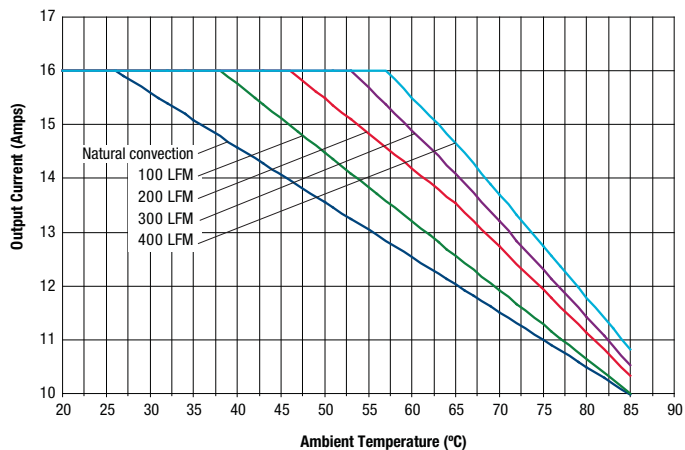

On/Off Enable Startup Delay (V_{IN}=8.3V, V_{OUT}=5V, I_{OUT}=16A, C_{LOAD}=0)
Trace 4=Enable In, Trace2=Vout

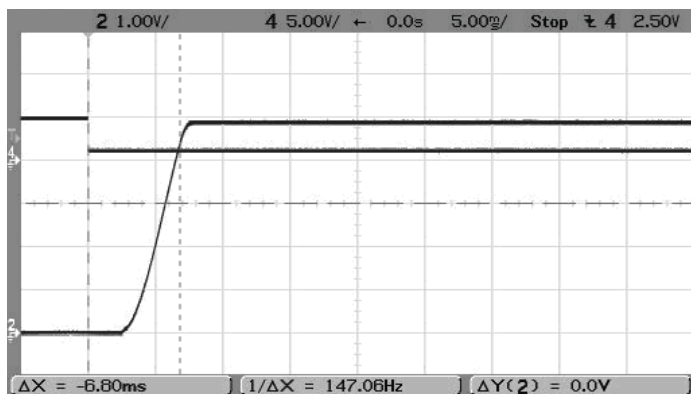

Output Ripple and Noise (V_{IN}=12V, V_{OUT}=5V, I_{OUT}=16A, C_{LOAD}=0, ScopeBW=100MHz)

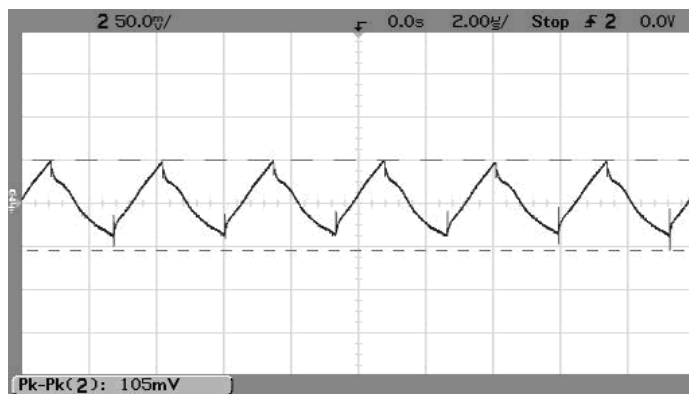

Step Load Transient Response (V_{IN}=12V, V_{OUT}=5V, C_{LOAD}=0, I_{OUT}=8A to 16A)
Trace 2=Vout, 100 mV/div., Trace4=Iout, 5A/div.

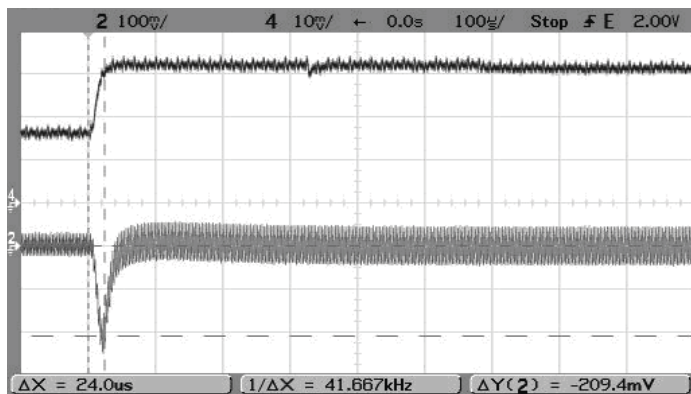

Step Load Transient Response (V_{IN}=12V, V_{OUT}=5V, C_{LOAD}=0, I_{OUT}=16A to 8A)
Trace 2=Vout, 100 mV/div., Trace4=Iout, 5A/div.

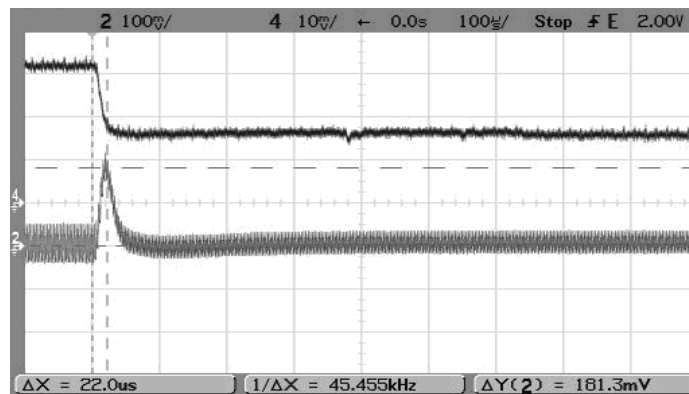

TAPE & REEL INFORMATION

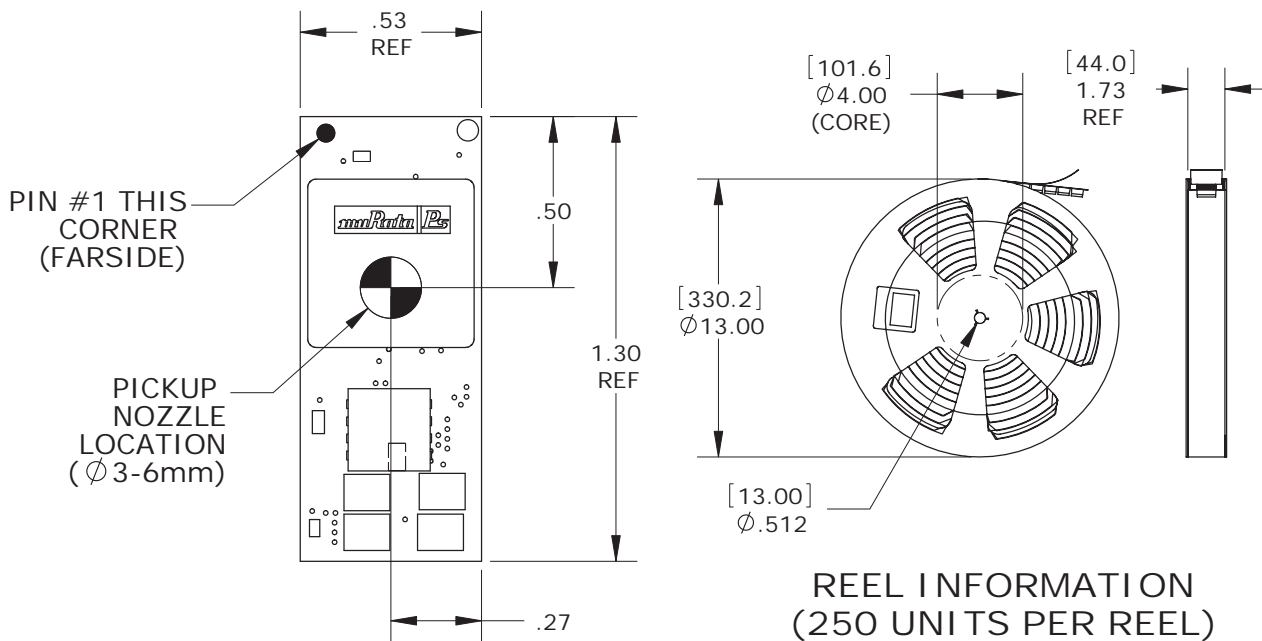
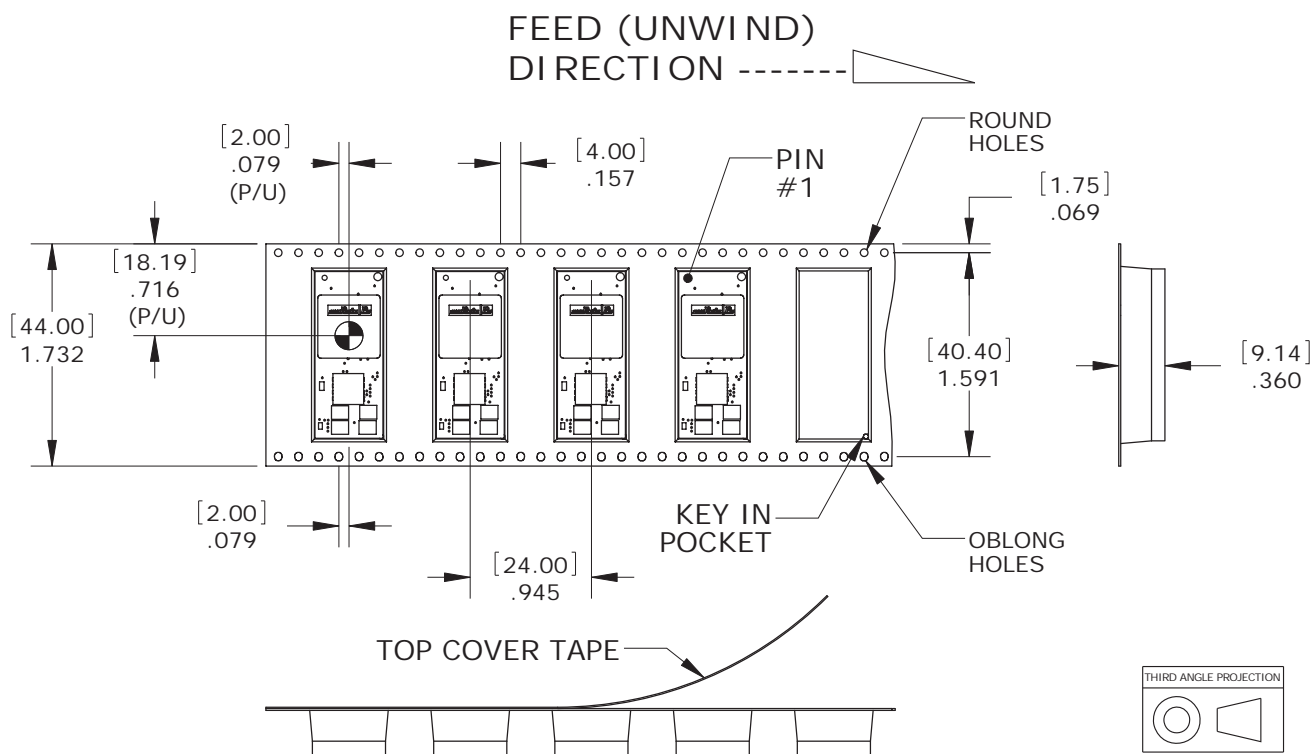

Product Label

Because of the small size of these products, the product label contains a character-reduced code to indicate the model number and manufacturing date code. Not all items on the label are always used. Please note that the label differs from the product photograph. Here is the layout of the label:

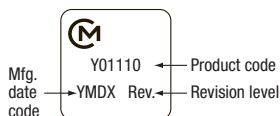

Figure 2. Label Artwork Layout

The label contains three rows of information:

- First row – Murata Power Solutions logo
- Second row – Model number product code (see table)
- Third row – Manufacturing date code and revision level

Mean Time Before Failure (MTBF) Table

These figures use a standard MTBF probability calculation as an indication of component parts stress and life derating. The calculator is based on separate MTBF values for all internal parts in addition to stated environmental conditions. Two MTBF values are presented. The Telcordia method is widely used in industry, particularly telecom. The United States MIL-HDBK method is for military and industrial applications. Please refer to a qualified reliability engineer for more background.

Model Number	MTBF (Hours)	Method [1,2]
OKY2-T/16-D12N-C	7,027,574	Telcordia
OKY2-T/16-D12N-C	5,506,128	MIL-HDBK

Notes:

- [1] Mean Time Before Failure is calculated using the Telcordia (Belcore) SR-332 Method 1, Case 3, ISSUE 2, ground fixed controlled conditions, Tambient=+25°C, full output load, natural air convection.
- [2] Mean Time Before Failure is calculated using MIL-HDBK-217FN2, GB ground benign, Tambient=+25°C, full output load, natural air convection.

Model Number	Product Code
OKY-T/10-D12P-C	Y01110
OKY-T/10-D12N-C	Y00110
OKY2-T/10-D12P-C	Y21110
OKY2-T/10-D12N-C	Y20110
OKY-T/16-D12P-C	Y01116
OKY-T/16-D12N-C	Y00116
OKY2-T/16-D12P-C	Y21116
OKY2-T/16-D12N-C	Y20116

The manufacturing date code is four characters:

- First character – Last digit of manufacturing year, example 2009
- Second character – Month code (1 through 9 and 0 through D)
- Third character – Day code (1 through 9 = 1 to 9, 10=0 and 11 through 31 = A through Z)
- Fourth character – Manufacturing information