

Features

- Efficiency up to 95%, Non isolated, no need for heatsinks
- Pin-out compatible with LM78XX Linears
- Low profile (L*W*H=11.5*8.5*17.5mm)
- Wide input range (4.75V ~ 18V)
- Short circuit protection, Thermal shutdown
- Non standard outputs available as specials between 1.5V ~ 6.5V
- Low ripple and noise
- "L" Version with 90° pins

Description

The R-78Bxx-1.5 Series high efficiency switching regulators are ideally suited to replace 78xx linear regulators and are pin compatible. The efficiency of up to 95% means that very little energy is wasted as heat so there is no need for any heat sinks with their additional space and mounting costs. The L-Version with 90° pins allows direct replacement for laid-flat regulators where component height is at a premium. Low ripple and noise figures and a short circuit input current of typically only 10mA round off the specifications of this versatile converter series.

Selection Guide

Part Number*	Input Range (1) (V)	Output Voltage (V)	Output Current (A)	Efficiency	
				Min. Vin (%)	Max. Vin (%)
R-78B1.5-1.5	4.75 – 18	1.5	1.5	83	78
R-78B1.8-1.5	4.75 – 18	1.8	1.5	85	81
R-78B2.5-1.5	4.75 – 18	2.5	1.5	88	84
R-78B3.3-1.5	4.75 – 18	3.3	1.5	91	88
R-78B5.0-1.5	6.5 – 18	5.0	1.5	94	92
R-78B6.5-1.5	8.0 – 18	6.5	1.5	95	93

* add Suffix "L" for 90° bent pins, e.g. R-78B5.0-1.5L

INNOLINE
DC/DC-Converter
with 3 year Warranty

RECOM

1.5 AMP
SIP3
Single Output



EN-55022 Certified
EN-55024 Certified
EN-60601-1-2 Certified
EN-60950-1 Certified

R-78B-1.5

Typical Application Circuit

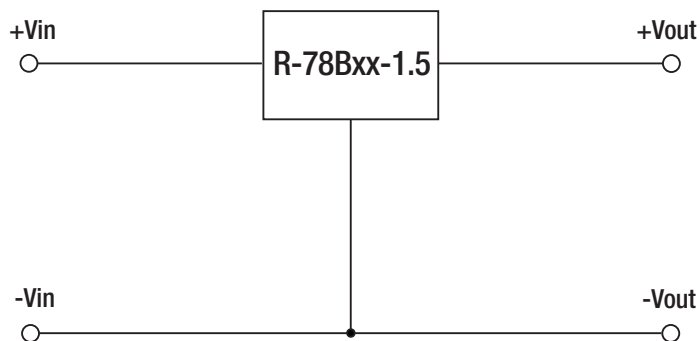

Derating-Graph (Ambient Temperature)

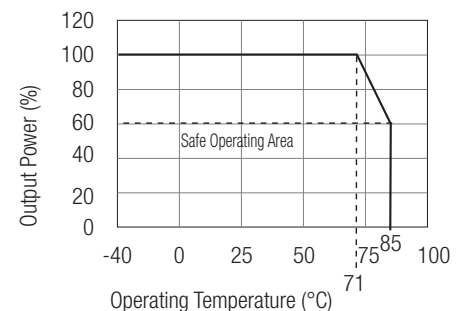

Specifications (refer to the standard application circuit, Ta: 25°C, minimum load = 10 %)

Characteristics	Conditions	Min.	Typ.	Max.
Input Voltage Range	All Series, see Selection Guide	4.75V		18.0V
Output Voltage Range (for customized parts)	All Series	1.5V		6.5V
Output Current	All Series	0mA*		1500mA
Output Current Limit	All Series			5000mA
Short Circuit Input Current (Vin = 12V)	All Series			100mA
Internal Power Dissipation				0.65W
Short Circuit Protection			Continuous, automatic recovery	
Output Voltage Accuracy (At 100% Load)	All Series		±2%	±3%
Line Voltage Regulation (Vin = min. to max. at full load)	All Series		0.2%	0.4%
Load Regulation (10% to 100% full load)	All Series		0.4%	0.6%
Dynamic Load Stability (with Output Capacitor=100µF)	100% <-> 50% load		±80mV	±120mV
	Transient Recovery Time		1.0ms	1.5ms
Ripple & Noise (10% to 100% full load)	All Series		15mV	30mVp-p
Temperature Coefficient	-40°C ~ +85°C ambient			0.015%/°C
Max capacitance Load	with normal start-up time, no external components			1000µF
	with <1 second start up time + diode protection circuit			6800µF
Switching Frequency		300kHz	340kHz	380kHz
Quiescent Current	Vin = min. to max. at 0% load		7mA	9mA
Input Reflected Ripple Current	All Series		150mA	200mA p-p
Operating Temperature Range		-40°C		+85°C
Operating Case Temperature				+100°C
Storage Temperature Range		-55°C		+125°C
Case Thermal Impedance				60°C / W
Thermal Shutdown	Internal IC junction			+160°C
Relative Humidity				95% RH
Case Material			Epoxy with Non-Conductive Plastic Case (UL94V-0)	
Package Weight			4g	
Packing Quantity				42 pcs per Tube
Conducted Emissions	EN55022			Class B
Radiated Emissions	EN55022			Class B
ESD	EN61000-4-2			Class A
Safety Certification	EN-60950-1			
MTBF (+25°C) (+71°C)	} Detailed Information see Application Notes chapter "MTBF"	using MIL-HDBK 217F		3250 x 10 ³ hours
		using MIL-HDBK 217F		1059 x 10 ³ hours

*Note: Operation under no load will not damage these devices, however they may not meet all specifications. A minimum load of 10mA is recommended

Characteristics

Efficiency

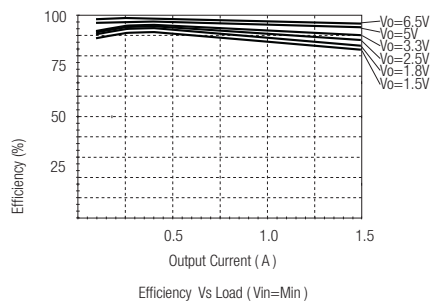
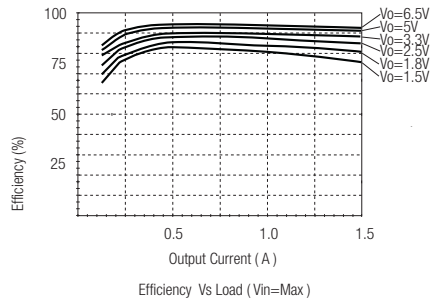
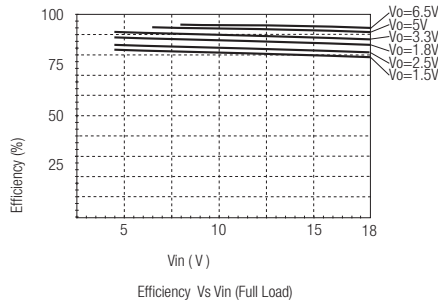

Ripple

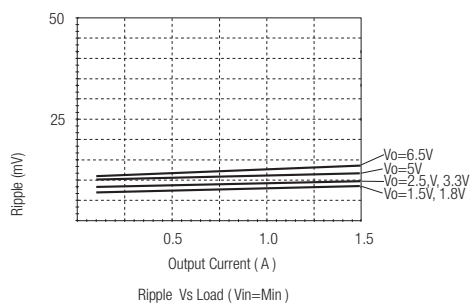
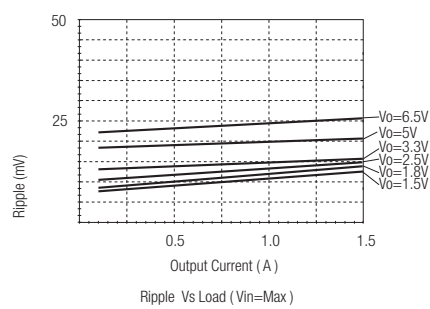
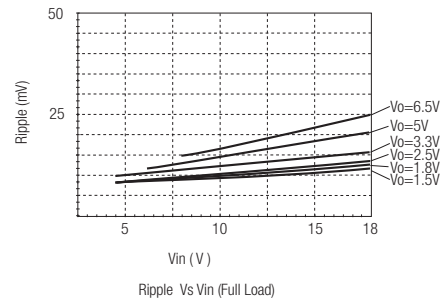

R-78B-1.5

Optional Protection Circuit

Optional Protection 1:

Add a blocking diode to Vout if current can flow backwards into the output, as this can damage the converter when it is powered down.

The diode can either be fitted across the device if the source is low impedance or fitted in series with the output (recommended).

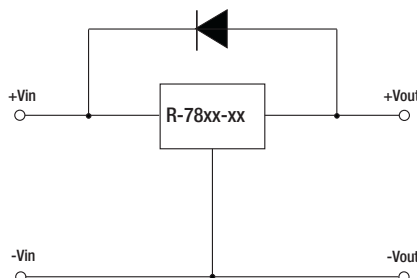

Optional Protection 2:

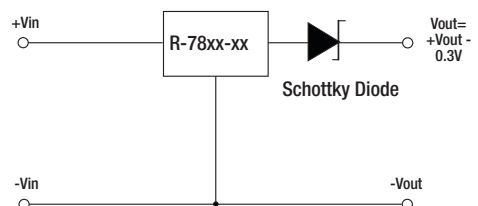

Application Examples

High efficiency multiple output

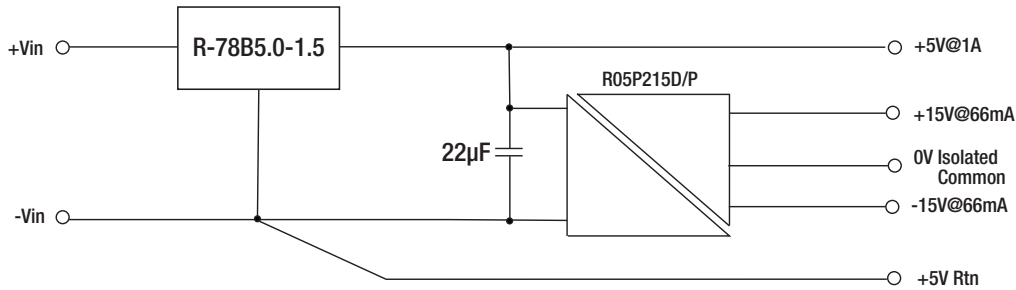

- Wide input range suits both 12V and 7.2V battery packs
- 5.2kV isolated short circuit protected outputs for analogue circuits, e.g. medical grade interface
- High efficiency +5V/1A protected output for digital circuits
- Further decoupling filtering may be necessary between the converters

Isolated, wide Input range, Distributed Power Architecture (Point of Load)

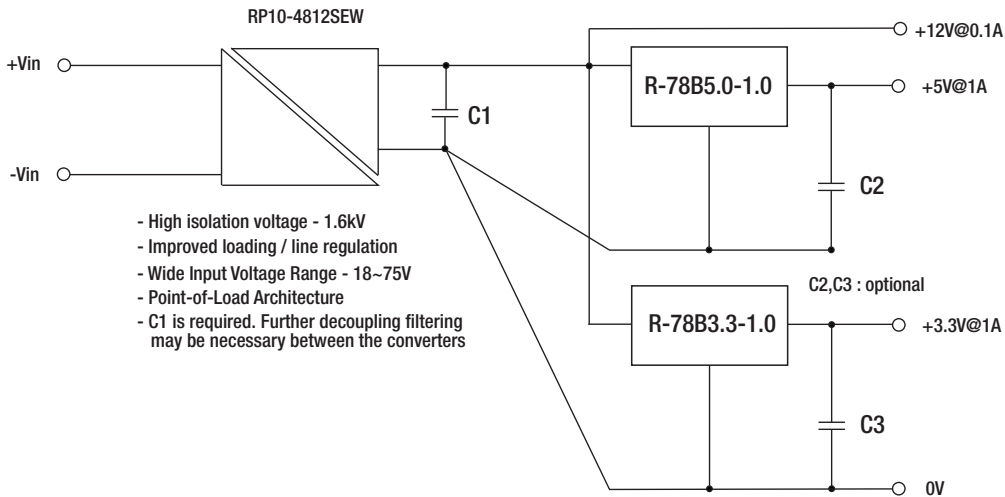

- High isolation voltage - 1.6kV
- Improved loading / line regulation
- Wide Input Voltage Range - 18~75V
- Point-of-Load Architecture
- C1 is required. Further decoupling filtering may be necessary between the converters

R-78B-1.5

Package Style and Pinning (mm)

SIP3 PIN Package

