



SERIES: V78XX-1000

DESCRIPTION: DC SWITCHING REGULATOR,
NON-ISOLATED

DESCRIPTION

The V78XX switching regulator series is designed to be a high efficiency drop-in replacement for 78XX linear regulators. Unlike linear regulators, the V78XX series does not require a heatsink, creating a much more compact solution. Built-in short-circuit and over-temperature protections ensure very rugged operations. Additionally, low ripple and noise performance make the parts useful in a wide range of applications.

FEATURES

- efficiency up to 97%
- 1A current output
- operating temp: -40 ~ +85°C
- short circuit protection
- thermal shutdown
- low ripple and noise
- miniature SIP package, meets UL94-V0 requirement
- ultra low power loss
- negative output capacity
- pin compatible to LM78XX series
- MTBF >2,000,000 hours



MODEL

MODEL	input voltage		output voltage	output current	efficiency level	
	min (V dc)	max (V dc)	max (V dc)	max. (mA)	Vin (min)	Vin (max)
V7803-1000	4.75	28	3.3	1,000	90	83
	4.75	28	-3.3	-600	80	82
V7805-1000	6.5	32	5.0	1,000	93	88
	7	27	-5.0	-600	85	87
V7806-1000	9	32	6.5	1,000	94	90
	7	25	-6.5	-400	88	90
V7809-1000	12	32	9.0	1,000	95	92
	7	23	-9.0	-400	89	91
V7812-1000	16	32	12	1,000	96	94
	7	20	-12	-300	89	91
V7815-1000	20	32	15	1,000	97	94
	7	17	-15	-300	87	92

*add suffix "R" for 90' pins, for example: V7803-1000R

OUTPUT

parameter	conditions/description	min	nom	max	units
voltage accuracy	at 100% load		±2	±3	%
line regulation	Vin = min to max at full load		±0.2	±0.4	%
load regulation	10% to 100%		±0.4	±0.6	%
output ripple	20 MHz bandwidth, typical application circuit		25	35	mVp-p
short circuit protection	continuous, auto-restart				
short circuit input power			0.5	1.8	W
current limit			2,000		mA
switching frequency	full load, input voltage range	300	340	380	KHz
quiescent current	positive output		5	8	mA
	negative output		7	13	mA
thermal shutdown			150		°C
temperature coefficient	-40 ~ +85°C			±0.02	%/°C
load capacitance				1,000	µF



SERIES: V78XX-1000

DESCRIPTION: DC SWITCHING REGULATOR,
NON-ISOLATED

COMMON SPECIFICATIONS

parameter	conditions/description	min	nom	max	units
operating temperature		-40		85	°C
operating case temperature				100	°C
storage temperature		-55		125	°C
storage humidity				95	%
cooling	free air convection				
lead temperature	1.5 mm from the case for 10 seconds			300	°C
case material	plastic (UL94-V0)				
MTBF		2,000,000			hours
package weight			3.7		g

MECHANICAL DRAWING

V78XX-1000

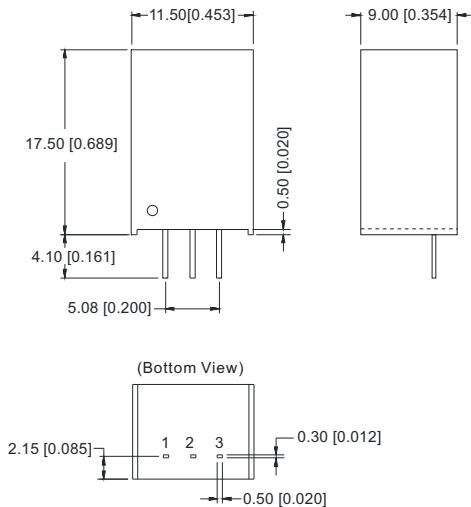

Note:
Unit: mm[inch]
Pin section tolerances: $\pm 0.10\text{mm} [\pm 0.004\text{inch}]$
General tolerances: $\pm 0.25\text{mm} [\pm 0.010\text{inch}]$

V78XX-1000R

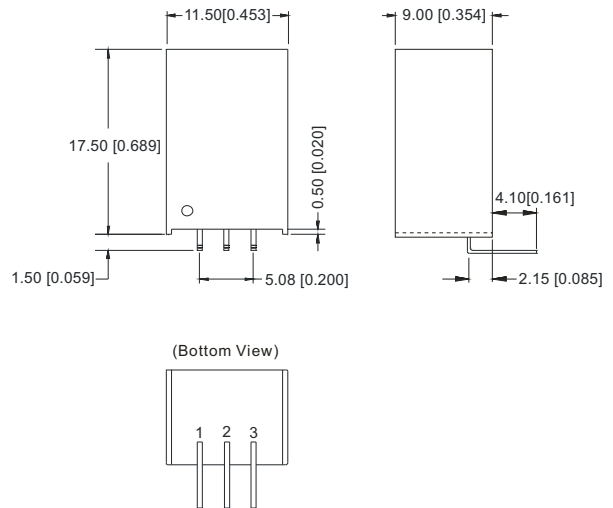

Note:
Unit: mm[inch]
Pin section tolerances: $\pm 0.10\text{mm} [\pm 0.004\text{inch}]$
General tolerances: $\pm 0.25\text{mm} [\pm 0.010\text{inch}]$



SERIES: V78XX-1000

DESCRIPTION: DC SWITCHING REGULATOR,
NON-ISOLATED

RECOMMENDED FOOTPRINT

V78XX-1000

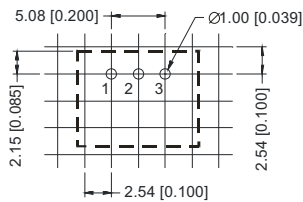

V78XX-1000R

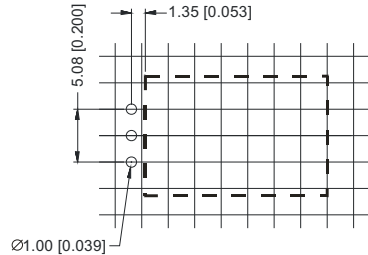

FOOTPRINT DETAILS		
Pin	Positive	Negative
1	+Vin	+Vin
2	GND	-Vout
3	+Vout	GND

DERATING CURVE

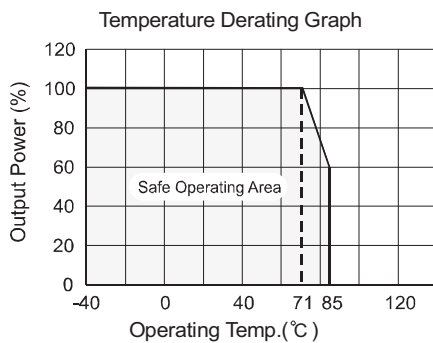

EXTERNAL CAPACITOR TABLE

Part Number	C1,C3 (Ceramic capacitor)	C2,C4 (Ceramic capacitor)
V7803-1000(R)	10 μ F/50V	22 μ F/6.3V
V7805-1000(R)	10 μ F/50V	22 μ F/10V
V7806-1000(R)	10 μ F/50V	10 μ F/10V
V7809-1000(R)	10 μ F/50V	10 μ F/16V
V7812-1000(R)	10 μ F/50V	10 μ F/25V
V7815-1000(R)	10 μ F/50V	10 μ F/25V

TYPICAL APPLICATION CIRCUIT

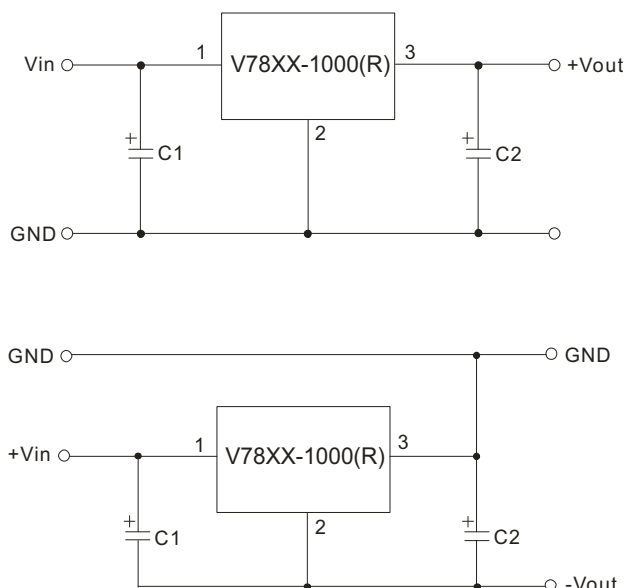

APPLICATION EXAMPLE

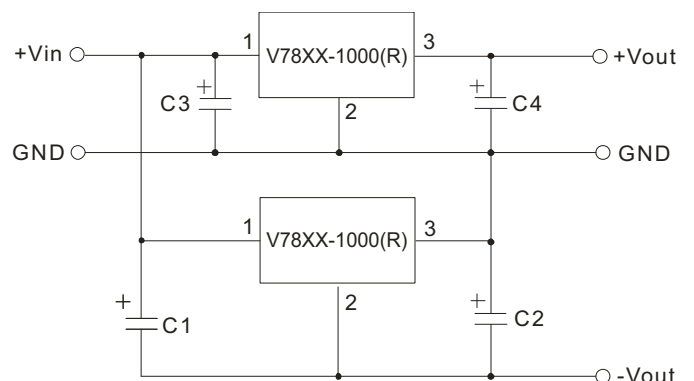

1. C1 and C2 are required and should be fitted close to the converter pins.
2. The capacitance of C1, C2, C3 and C4 sees external capacitor table, it can be increased properly if required, and tantalum or low ESR electrolytic capacitors may also suffice.
3. No parallel connection or plug and play.



SERIES: V78XX-1000

DESCRIPTION: DC SWITCHING REGULATOR,
NON-ISOLATED

OUTPUT RIPPLE REDUCTION

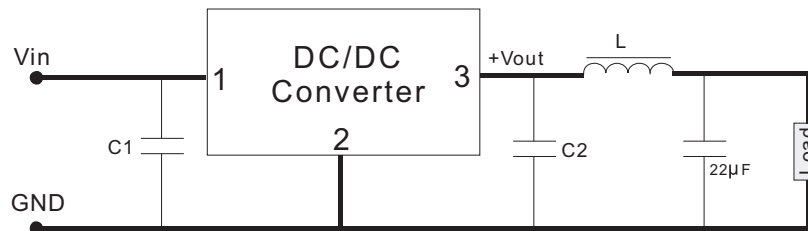

To reduce output ripple, it is recommended to add a LC filter in output port.

L: Recommended parameter 10µH ~ 47µH.

TEST CONFIGURATION

Efficiency and Output Voltage Ripple Test

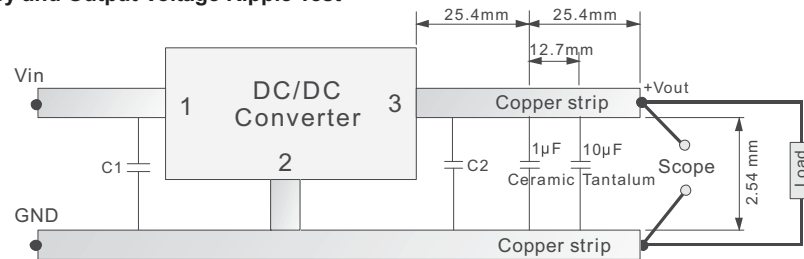

Start-up and Load Transient Response Test

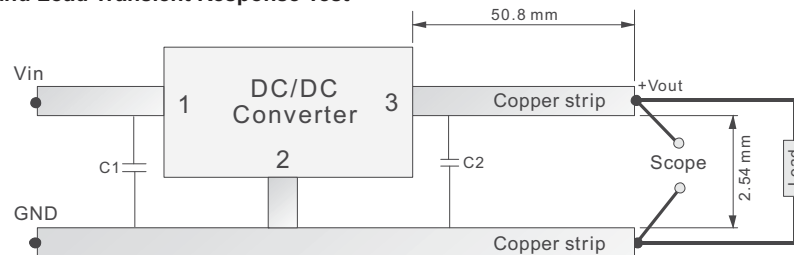



SERIES: V78XX-1000

DESCRIPTION: DC SWITCHING REGULATOR,
NON-ISOLATED

EFFICIENCY AND RIPPLE CURVES

Efficiency

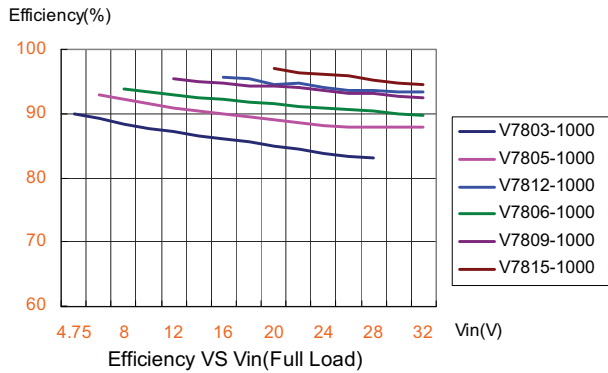

Ripple

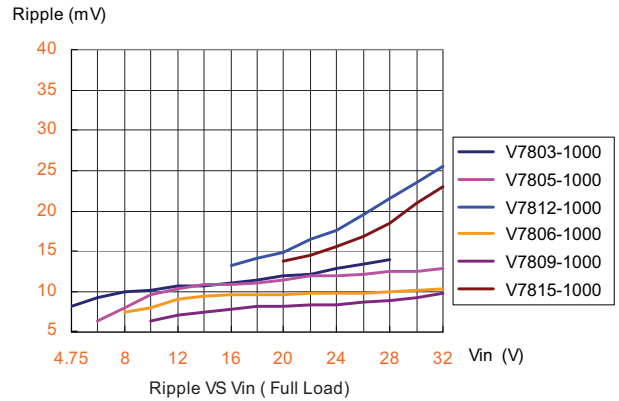

Efficiency(%)

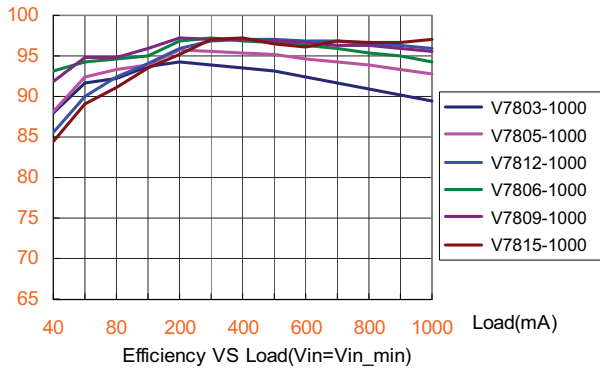

Ripple(mV)

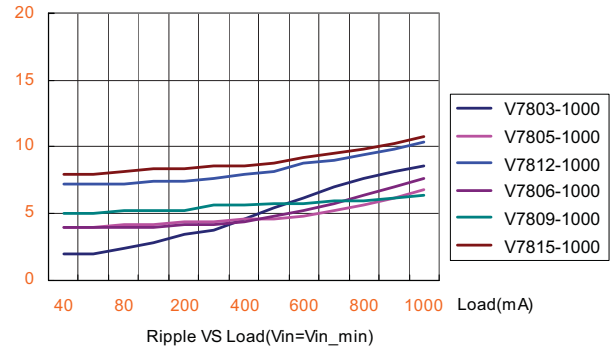

Efficiency(%)

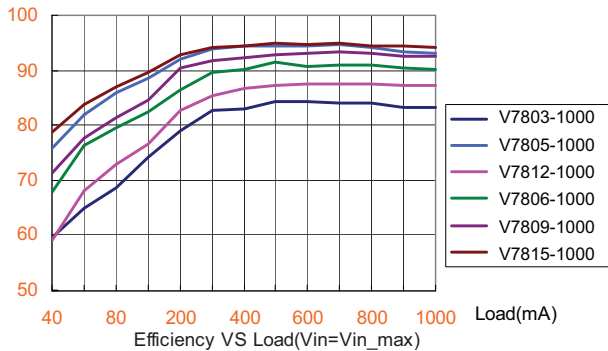

Ripple(mV)

