

Features

- Non-Isolated
- Synchronous rectification design
- Adjustable Output voltage
- 2, 3, 4AMP Adjustable Positive Step Down Integrated Switching Regulator
- Over load protection (125% full load typical)
- Remote ON/OFF Control(Ground Off)
- Wide Input Range
- UL94V-0 Package Material
- Continuous short circuit protection (Very low short current $I_{in\ sc} < 50mA$)
- Input voltage range 4.5V~28V
- Efficiency to 97 %

Description

The R-7XXX series is a high performance 2.5V to 15V , 2Amp to 4Amp, 12-Pin SIP (single in-line package), Integrated switching regulator (ISR). The Synchronous - rectified design yields excellent efficiencies up to 97%. Short circuit protection with crowbar function reduces the short circuit current to under 50mA of input current.

Selection Guide

Part Number SIP12	Input Range (V)	Nominal Output Voltage (V)	Vout Adjust Range (V)	Output Current (A)	Efficiency (%)		
					Min. Vin	12V	Max. Vin
R-723.3x	4.5 – 28	3.3	2.5 – 5.5	2	95	93	89
R-725.0x	6.5 – 28	5.0	3.0 – 5.5	2	96	95	91
R-726.5x	8.5 – 28	6.5	5.0 – 8.0	2	97	96	93
R-729.0x	12 – 28	9.0	7.0 – 11	2	96	-	93
R-7212x	15 – 28	12	10 – 14	2	97	-	95
R-7215x	19 – 28	15	13 – 17	2	97	-	96
R-733.3x	4.5 – 28	3.3	2.5 – 5.5	3	94	93	89
R-735.0x	6.5 – 28	5.0	3.0 – 5.5	3	95	95	92
R-736.5x	8.5 – 28	6.5	5.0 – 8.0	3	97	96	93
R-739.0x	12 – 28	9.0	7.0 – 11	3	96	-	94
R-7312x	15 – 28	12	10 – 14	3	97	-	96
R-7315x	19 – 28	15	13 – 17	3	97	-	96
R-743.3x	4.5 – 28	3.3	2.5 – 5.5	4	93	92	88
R-745.0x	6.5 – 28	5.0	3.0 – 5.5	4	95	94	91
R-746.5x	8.5 – 28	6.5	5.0 – 7.5	4	96	96	93

Note: $V_{in} - V_{out} \geq 1.5V - 4.0V$ depending on V_{out} if adjust function is used!

Suffix x: (see mechanical drawing for details)

x = P pins vertical through hole

x = D pins bent for horizontal through hole mounting

INNOLINE
DC/DC-Converter
with 3 year Warranty

RECOM

2, 3, 4 AMP
SIP12
Vertical &
Horizontal



EN-60950-1 Certified

R-7xxx

Specifications (refer to the standard application circuit, Ta: 25°C)

Characteristics	Conditions	Min.	Typ.	Max.
Output Voltage Range	All Series	2.5		17V
Output Current	R-72xxP/D R-73xxP/D R-74xxP/D	0.2 0.3 0.4		2.0A 3.0A 4.0A
Output Current Limit	R-72xxP/D R-73xxP/D R-74xxP/D		2.5 3.75 5.0	3.0A 4.25A 5.5A
Short Circuit Input Current	All Series		50	100mA
Short Circuit Protection	Continuous, automatic recovery			
Output Voltage Accuracy (At 100% Load)	All Series		±1%	±2%
Line Voltage Regulation (Vin = min. to max. at full load)	All Series		0.5	1.0%
Load Regulation (10 to 100% full load)	All Series		0.5	1.0%
Ripple & Noise	All Series		40mVp-p	70mVp-p
Transient Response (see note 1)	50% Load Change – Vout Over / Undershoot		100µs	200µs 100mV
Remote ON / OFF (see note 2)	Open or High (Power ON) Low (Power OFF)	4.5		28V 0.8V
Max capacitance Load	with normal start-up time, no external diodes with <1 second start up time + diode protection circuit			200µF 6800µF
Switching Frequency		270	300	330kHz
Shutdown current	ON / OFF Pin pulled low			100µA
Quiescent Current	Vin = min. to max. at 0% load			30mA
Operating Temperature Range		-40°C		+85°C
Operating Case Temperature				+110°C
Storage Temperature Range		-40°C		+125°C
Thermal Impedance	Natural Convection			25°C/W
Internal Power Dissipation	Ta < 60°C			1.4W
Package Weight				9g
Packing Quantity				15 pcs per Tube
MTBF (Nominal Vout, 100% load)	Tamb. = +25°C Tamb. = +85°C	} Detailed Information see Application Notes chapter "MTBF"		749 x 10 ³ hours 150 x 10 ³ hours

R-7xxx

Notes:

- Requires a 100µF electrolytic or tantalum output capacitor for proper operation in all applications (the capacitor to be placed as close as possible to the output pins).
- ON / OFF pin driven by TTL (logic gate), open-collector bipolar transistor or open-drain MOSFET.

Output Current vs Input Voltage

How to calculate the max output current

The internal power dissipation(P_D)follows the equation:

$$P_D = I_o \times V_o \times (1-\eta)$$

$$I_o = P_D / V_o \times (1-\eta)$$

Where P_D = Internal power dissipation

I_o = Output current

V_o = Output voltage

η = Efficiency

Example: R-745.0P , at Vin = 28Vdc , Vo = 5Vdc , η=91% (see "Selection Guide" table)

(a) When Ta = 60°C , P_D = 1.4 Watt (see beside diagram)

$$I_o = 1.4(W) / 5(V) \times (1-0.91) = 3.11(A)$$

(b) When Ta = 85°C , P_D = 1 Watt (see beside diagram)

$$I_o = 1(W) / 5(V) \times (1-0.91) = 2.222(A)$$

(c) At Vin = 12Vdc efficiency = 94% (see "Selection Guide" table)

When Ta = 85°C , P_D = 1 Watt (see beside diagram)

$$I_o = 1(W) / 5(V) \times (1-0.94) = 3.33(A)$$

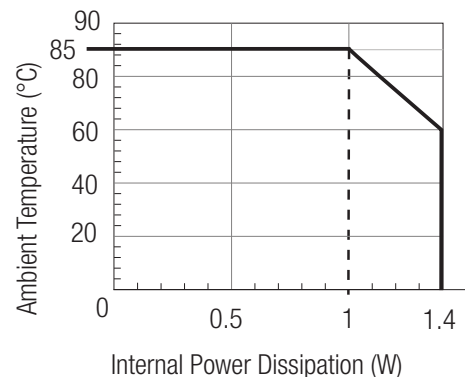

Characteristics

R-72xx / R-73xx
Ripple VS Vin

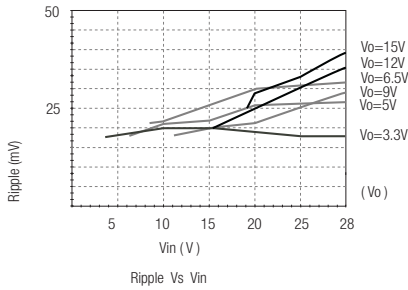

R-74xx
Ripple VS Vin

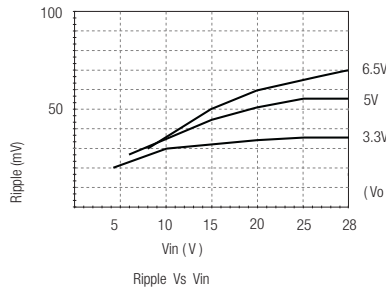

R-72xx / R-73xx
Efficiency VS Vin

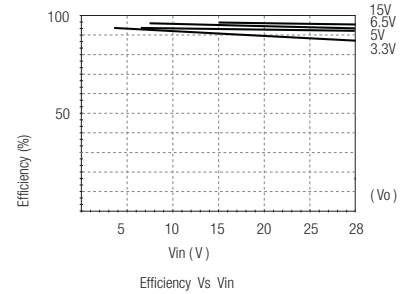

R-74xx
Efficiency VS Vin

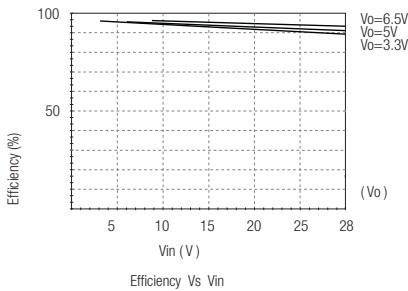

R-72xx / R-73xx / R-74xx
Efficiency / Load Vin=Min

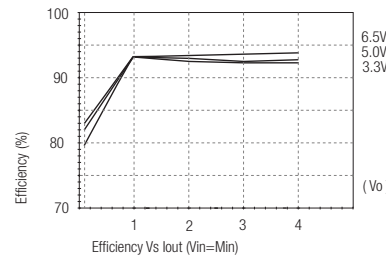

R-72xx / R-73xx / R-74xx
Efficiency / Load Vin=Max

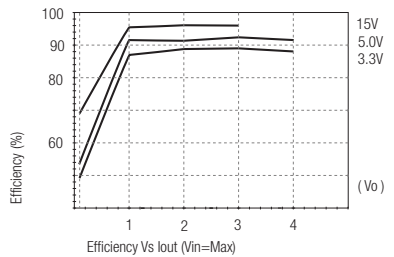

Package Style and Pinning (mm)

SIP12 PIN Package

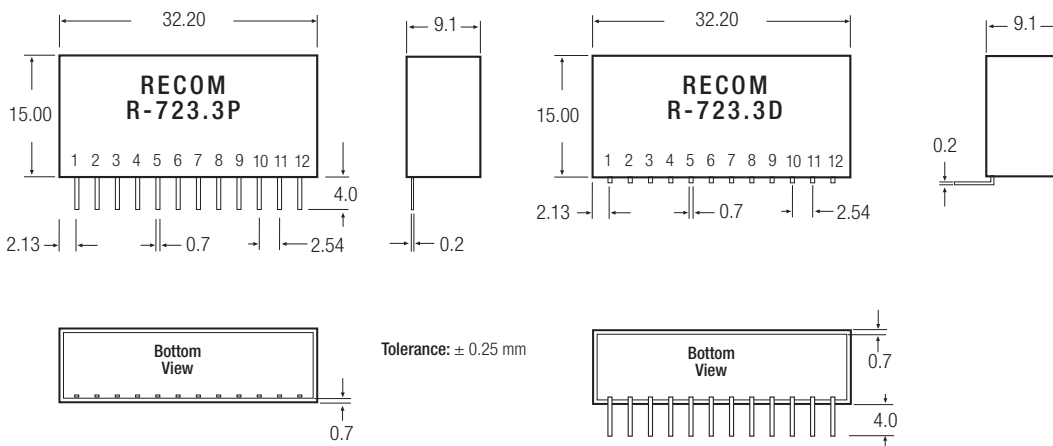

Pin Connections

Pin #	Name	Description
1	ON / OFF	Input pin : Active low (less than 0.8V) to disable the device
2, 3, 4	Vin	Power input
5, 6, 7, 8	GND	Input and output ground (common)
9, 10, 11	Vout	Power output
12	Vout-Adj	With external resistors R1,R2 to selected output voltage

Table 1: Adjustment Resistor Values

2A DC	R-723.3P/D	R-725.0P/D	R-726.5P/D	R-729.0P/D	R-7212P/D	R-7215P/D						
3A DC	R-733.3P/D	R-735.0P/D	R-736.5P/D	R-739.0P/D	R-7312P/D	R-7315P/D						
4A DC	R-743.3P/D	R-745.0P/D	R-746.5P/D									
Vout (nominal)	3.3VDC		5.0VDC		6.5VDC		9.0VDC		12VDC		15VDC	
Vout (adj)	R1	R2	R1	R2	R1	R2	R1	R2	R1	R2	R1	R2
2.5	8.5KΩ											
3.0	33KΩ		470Ω									
3.2	110KΩ		1.6KΩ									
3.3			2.2KΩ									
3.4		36KΩ	3.0KΩ									
3.6		11KΩ	4.7KΩ									
3.9		4.7KΩ	8.5KΩ									
4.5		1.6KΩ	30KΩ									
4.9		820Ω	220KΩ									
5.0		680Ω			11KΩ							
5.1		560Ω	28KΩ		12KΩ							
5.5		190Ω	2.6KΩ		20KΩ							
6.0					47KΩ							
6.5												
7.0						560Ω	13KΩ					
8.0						330Ω	31KΩ					
9.0												
10								2.2KΩ	20KΩ			
11								390Ω	47KΩ			
12												
13										2.4KΩ	36KΩ	
14										390Ω	76KΩ	
15												
16												2.6KΩ

R-7xxx

Standard Application Circuit

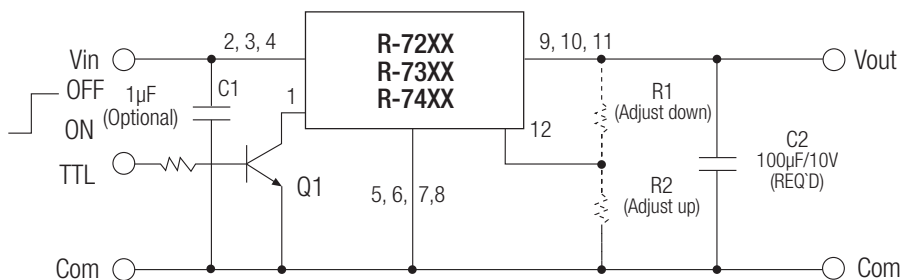

Add a blocking diode to Vout if current can flow backwards into the output, as this can damage the converter.

Protection diodes are required for high capacitive loads.

Refer to R-5xxxA Datasheet for circuit suggestions.