

Features

- Efficiency up to 94%, no need for heatsinks!
- Pin-out compatible with LM78XX Linear Regs.
- Low profile (L*W*H=11.5*7.5*10.2mm)
- Wide input range (4.75V ~ 18V)
- Short circuit protection, thermal shutdown
- Non standard outputs available as specials
- Low ripple and noise

Selection Guide

| Part Number | Input Range (V) | Output Voltage (V) | Output Current (A) | Efficiency | |
|-------------|-----------------|--------------------|--------------------|--------------|--------------|
| | | | | Min. Vin (%) | Max. Vin (%) |
| R-781.8-1.0 | 4.75 – 18 | 1.8 | 1.0 | 82 | 76 |
| R-782.5-1.0 | 4.75 – 18 | 2.5 | 1.0 | 87 | 81 |
| R-783.3-1.0 | 4.75 – 18 | 3.3 | 1.0 | 90 | 84 |
| R-785.0-1.0 | 6.5 – 18 | 5.0 | 1.0 | 94 | 89 |

Specifications (typical at 25°C, 10% minimum load, unless otherwise specified)

| Characteristics | Conditions | Min. | Typ. | Max. |
|--|---|---------------------|--------------------------------|--------------------------------|
| Input Voltage Range | All Series | 4.75V | | 18V |
| Output Voltage Range | All Series | 1.5V | | 5.5V |
| Output Current | All Series | 0mA* | | 1000mA |
| Output Current Limit | All Series | | | 3000mA |
| Short Circuit Input Current (Vin =12V) | All Series | | | 100mA |
| Internal Power Dissipation | | | | 0.4W |
| Short Circuit Protection | | | Continuous, automatic recovery | |
| Output Voltage Accuracy (At 100% Load) | All Series | | ±2% | ±3% |
| Line Regulation (100% Load, Vin max.) | All Series | | 0.2% | 0.4% |
| Load Regulation (10 to 100% full load) | All Series | | 0.4% | 0.6% |
| Dynamic Load Stability | 100% <-> 50% load | | ±85mV | ±100mV |
| Ripple & Noise (20Mhz BW) | All Series | | 20mVp-p | 30mVp-p |
| Temperature Coefficient | -40°C ~ +85°C ambient | | | 0.015%/°C |
| Max capacitance Load | with normal start-up time, no external components | | | 470µF |
| | with <1 second start up time + diode protection circuit | | | 6800µF |
| Switching Frequency | | 280kHz | 350kHz | 430kHz |
| Quiescent Current | Vin = min. to max. at 0% load | | 5mA | 7mA |
| Operating Temperature Range | | -40°C | | +85°C |
| Operating Case Temperature (with derating) | | | | +100°C |
| Storage Temperature Range | | -55°C | | +125°C |
| Case Thermal Impedance | | | | 70°C/W |
| Thermal Shutdown | Internal IC junction | | | +160°C |
| Conducted Emissions (with filter) | EN55022 | | | Class B |
| Radiated Emissions (with filter) | EN55022 | | | Class B |
| ESD | EN61000-4-2 | | | Class A |
| Radiated Immunity | EN61000-4-3 | | | Class A |
| Fast Transient | EN61000-4-4 | | | Class A |
| Conducted Immunity | EN61000-4-6 | | | Class A |
| Magnetic Field Immunity | EN61000-4-8 | | | Class A |
| Certifications | | | | |
| General Safety | Report: PS080803950 | | EN 60950-1:2001 + All:2004 | |
| Medical EMC | Report: 5A111502E | | EN 60950-1-1-2:2002 | |
| EMC | Report: 5A111502E | | EN 55022, EN55024, EN61000 | |
| Package Weight | | | 1.9g | |
| Packing Quantity | | | | 42 pcs per Tube |
| MTBF (+25°C) | } Detailed Information see Application Notes chapter "MTBF" | using MIL-HDBK 217F | | 13338 x 10 ³ hours. |
| (+71°C) | | using MIL-HDBK 217F | | 3880 x 10 ³ hours. |

INNOLINE
DC/DC-Converter
with 3 year Warranty

RECOM

1.0 AMP
SIP3
Single Output



EN-55022 Certified
EN-55024 Certified
EN-60601-1-2 Certified
EN-60950-1 Certified

R-78-1.0

Description

The R-78xx-1.0 series switching regulators are ideally suited to replace 1 Amp 78xx linear regulators and are pin compatible. Efficiencies of up to 97% means that very little energy is wasted as heat so there is no need for any heat sinks with their additional space and mounting costs.

Derating-Graph (Ambient Temperature)

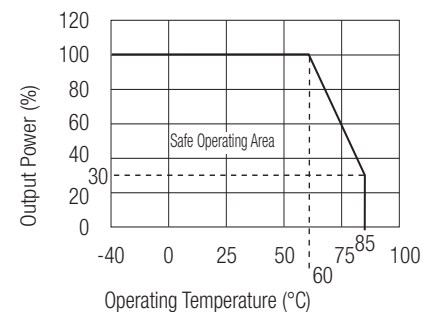

R-78-1.0

Characteristics

Efficiency

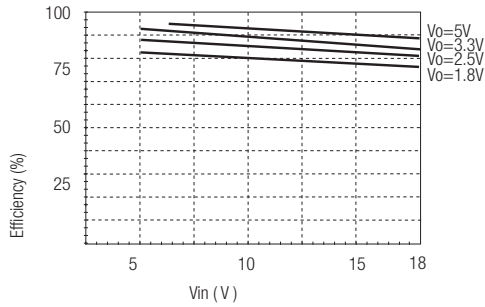

Efficiency Vs Vin (Full Load)

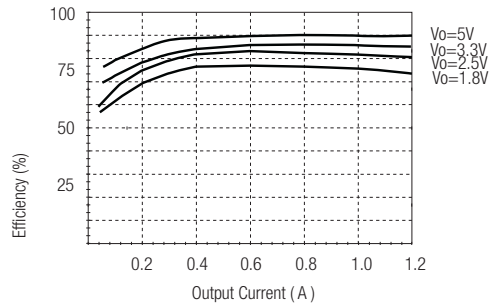

Efficiency Vs Load (Vin=Max)

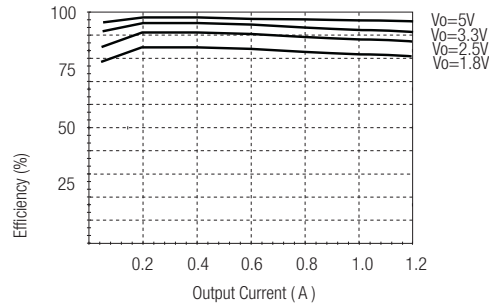

Efficiency Vs Load (Vin=Min)

Ripple

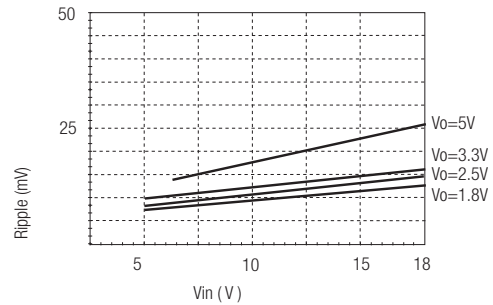

Ripple Vs Vin (Full Load)

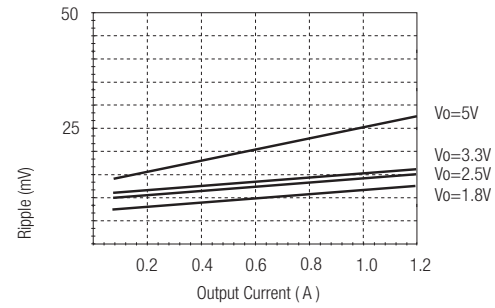

Ripple Vs Load (Vin=Max)

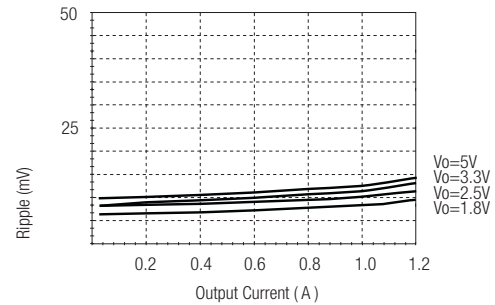

Ripple Vs Load (Vin=Min)

R-78-1.0

*Note: Operation under no load will not damage these devices, however they may not meet all specifications. A minimum load of 10mA is recommended

Optional Protection Circuit

Optional Protection 1:

Add a blocking diode to Vout if current can flow backwards into the output, as this can damage the converter when it is powered down.

The diode can either be fitted across the device if the source is low impedance or fitted in series with the output (recommended).

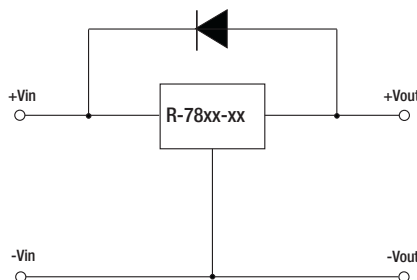

Optional Protection 2:

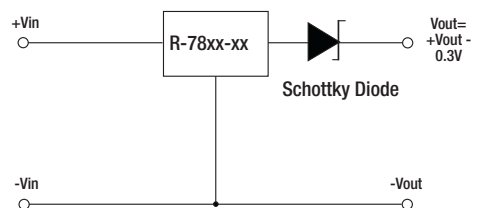

INNOLINE

DC/DC-Converter

R-78xx-1.0 Series

Application Examples

High efficiency, isolated, dual regulated outputs

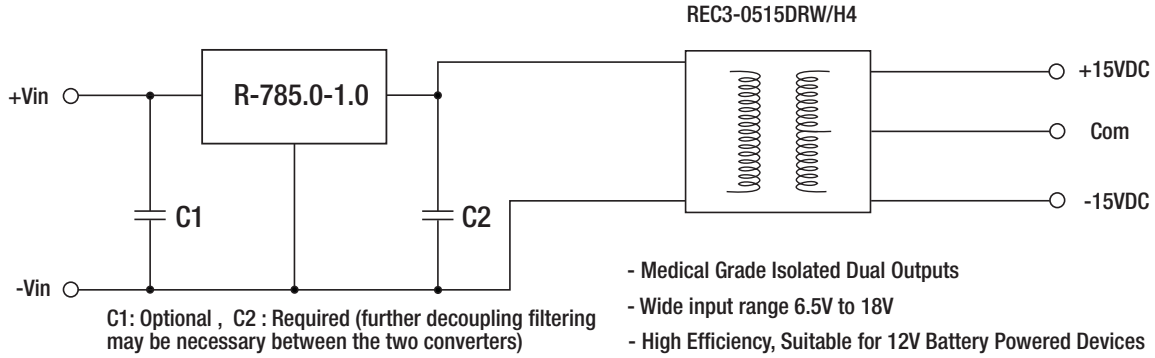

Isolated (up to 6KV), wide Input range regulated output

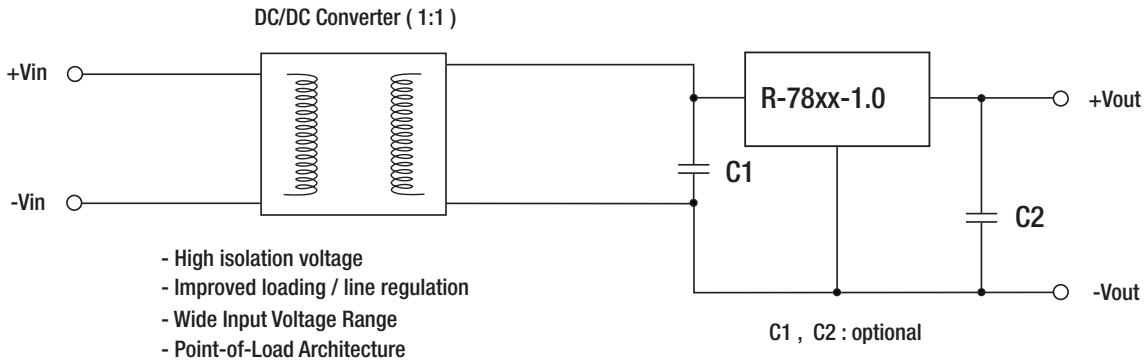

R-78-1.0 Package Style and Pinning (mm)

SIP3 PIN Package

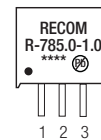
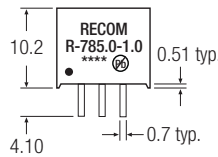

Recommended Footprint Details

Pin Connections

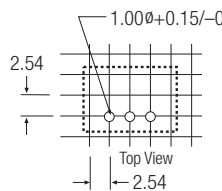
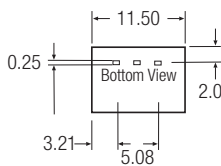

| Pin # | |
|-------|-------|
| 1 | +Vin |
| 2 | GND |
| 3 | +Vout |

xx.x ±0.5mm