

**PART NUMBER:** V78XX-500-SMT

**DESCRIPTION:** DC switching regulator, non-isolated

### description

The V78XX series of switching regulators is designed as a drop in replacement for 78XX linear regulators. Because the V78XX series features high efficiency under all line conditions, there is no need for a heatsink. Built-in short-circuit and over-temperature protections ensure very rugged operations. Additionally, low ripple and noise performance makes the parts useful in a wide range of applications.

### features

- efficiency up to 96%
- no need for heatsinks
- wide input range
- short circuit protection
- thermal shutdown
- low ripple and noise
- non-isolated



MODEL	input voltage	input voltage	output voltage	output voltage	output current	efficiency	
	nominal	range	nominal	range		Vin_min	Vin_max
V7803-500-SMT	12	4.5~28 V dc	3.3	1.8~5.5 V dc	500 mA	90%	75%
V7805-500-SMT	12	6~28 V dc	5	2.5~8 V dc	500 mA	94%	81%
V7812-500-SMT	24	14~28 V dc	12	4.5~13.5 V dc	500 mA	95%	90%
V7815-500-SMT	24	17~28 V dc	15	4.5~15.5 V dc	500 mA	96%	92%

- notes
1. Vin-Vo>2V, If needed to adjust the output voltage .
  2. If the input voltage is above specified then permanent damage may be caused to the device.
  3. V7812-500-SMT and V7815-500-SMT are not allowed to operate under no load.

## OUTPUT SPECIFICATIONS

item	conditions	min.	typ.	max.	unit
output voltage accuracy	at 100% load		±2	±3	%
line regulation	Vin = min. to max. at full load		±0.2	±0.5	%
load regulation	10% to 100% full load		±0.3	±0.75	%
output ripple	20 MHz bandwidth, output w/ 10µF cap		10	25	mVp-p
short circuit protection	continuous, auto recovery upon removal of short				
output current limit			1800		mA
dynamic load stability	100%<->10% load		±30	±75	mV
quiescent current	normal input (3.3, 5 V output)		15		mA
thermal shutdown			160		°C
temperature coefficient	-40°C ~ 85°C ambient			0.02	%/°C
max load capacitance				1000	µF

## GENERAL SPECIFICATIONS

item	conditions	min.	typ.	max.	unit
On/Off control current	on: open or 1.5<Vc≤5V off: GND or 0V<Vc<1V				
On/Off shutdown threshold voltage		1.1	1.25	1.4	V
shutdown input current			15	30	µA
operating temperature range	see derating curve	-40		85	°C
operating case temperature				100	°C
storage temperature range		-55		125	°C
cooling	free air convection				
solderability	1.5 mm from case for 10 seconds			260	°C
storage humidity	relative humidity, non-condensing			95	%
case material	plastic (UL94-V0)				
MTBF	at 25°C per MIL-HDBK-217F	2,000,000			hours
package weight			2.3		grams

**PART NUMBER:** V78XX-500-SMT

**DESCRIPTION:** DC switching regulator, non-isolated

## MECHANICAL DRAWINGS

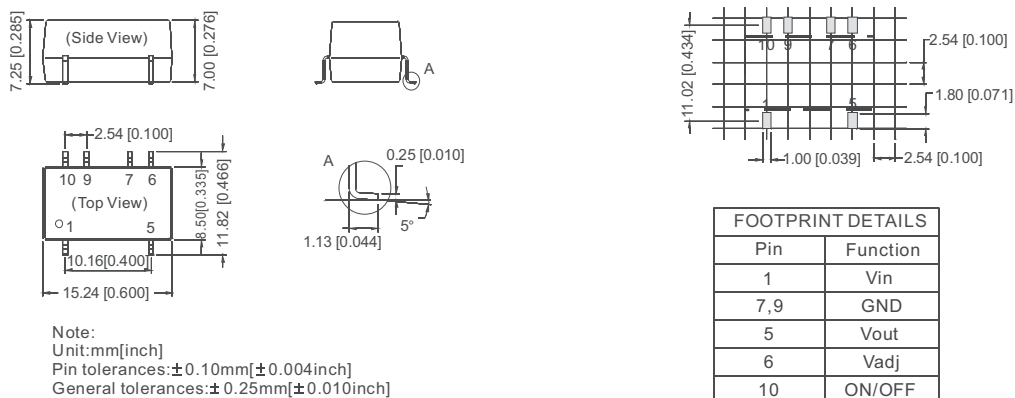

## PACKAGING DIMENSIONS

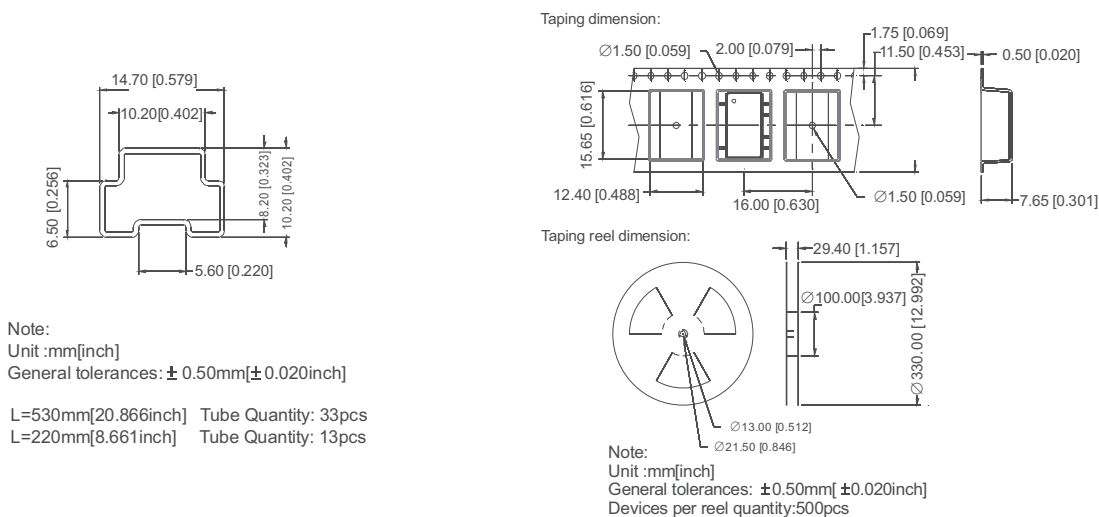

## THERMAL DERATING CURVE

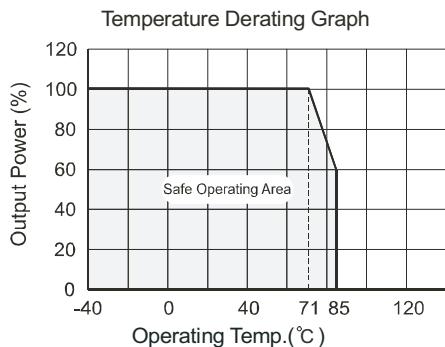

## SOLDER REFLOW PROFILE

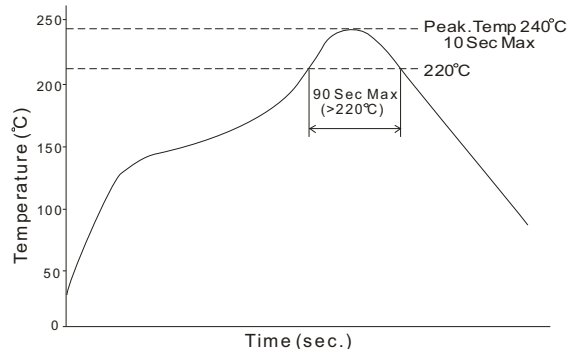

**PART NUMBER:** V78XX-500-SMT

**DESCRIPTION:** DC switching regulator, non-isolated

## TYPICAL APPLICATION CIRCUIT

Choose a ceramic type capacitors; C3 is require ,for best performance , use a 100µF or more capacitor please.

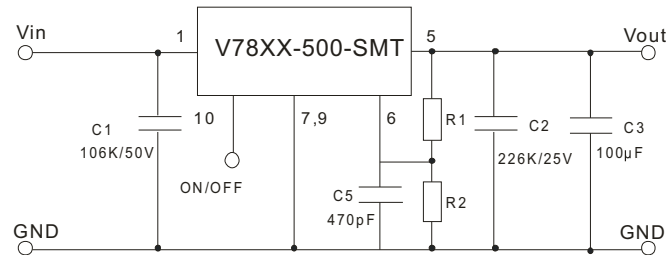

1. C1,C2: Use ceramic capacitors; C3: Use a 100 µF or more capacitor.
2. C1,C2 are required and should be placed close to the pins of the converter, with shortest possible leads.
3. No parallel connection or plug and play.

## EXTERNAL CAPACITOR TABLE

Part Number	C1 (ceramic capacitor)	C2 (ceramic capacitor)
V7803-500-SMT	10uF/50V	22uF/16V
V7805-500-SMT	10uF/50V	22uF/16V
V7812-500-SMT	10uF/50V	10uF/25V
V7815-500-SMT	10uF/50V	10uF/25V

## OUTPUT TRIMMING

Part Name	Vo nom	Trim Down	Trim Up
		R1(KΩ)	R2(KΩ)
V7803-500-SMT	3.3V	$= \frac{61 * V_o - 75.10}{3.3 - V_o}$	$= \frac{75.10 - 10 * V_o}{V_o - 3.3}$
V7805-500-SMT	5.0V	$= \frac{61 * V_o - 91.52}{5.0 - V_o}$	$= \frac{91.52 - 10 * V_o}{V_o - 5.0}$
V7812-500-SMT	12V	$= \frac{71 * V_o - 287.02}{12 - V_o}$	$= \frac{287.02 - 20 * V_o}{V_o - 12}$
V7815-500-SMT	15V	$= \frac{66 * V_o - 269.37}{15 - V_o}$	$= \frac{269.37 - 15 * V_o}{V_o - 15}$

To trim the output of the device input the desired output voltage (Vo) into the proper equation. R1 trims the output voltage down and R2 trims the voltage up. If not using the trim feature place a 470pF ceramic capacitor between pin 6 and GND. Make sure that the desired output voltage is within the trim range.

**PART NUMBER:** V78XX-500-SMT

**DESCRIPTION:** DC switching regulator, non-isolated

## TEST CIRCUIT

### 1) Efficiency and Output Voltage Ripple Test

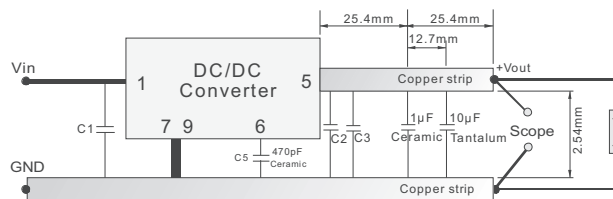

### 2) Start-up and Load Transient Response Test

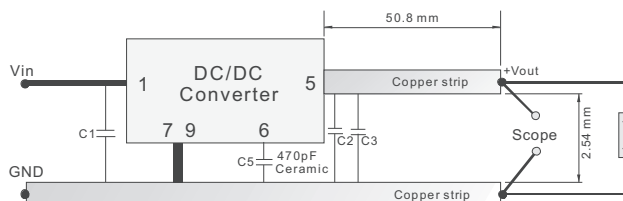

## EFFICIENCY AND RIPPLE

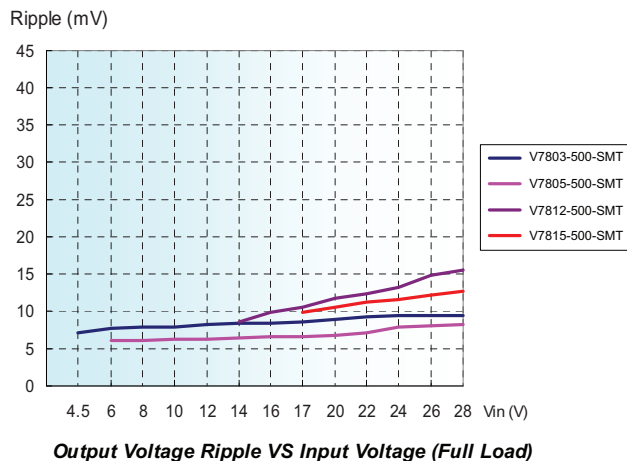
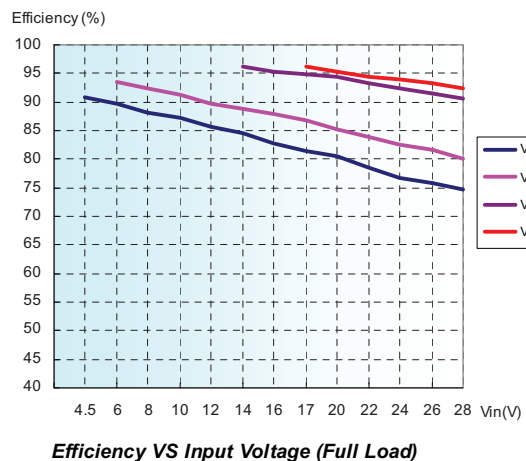
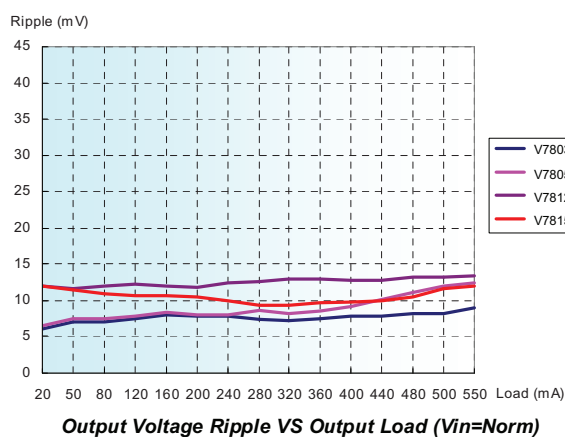
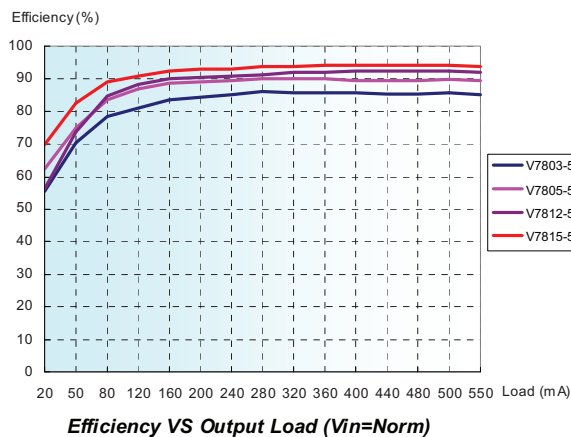

**PART NUMBER:** V78XX-500-SMT

**DESCRIPTION:** DC switching regulator, non-isolated

## SHUTDOWN CONTROL

The ON/OFF pin provides several features for adjusting and sequencing the power supply, a user has the flexibility of using the ON/OFF pin as:

- 1) A digital on/off control by pulling down the ON/OFF pin with an open-drain transistor.

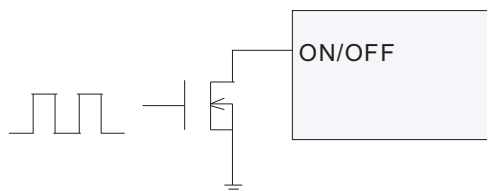

- 2) Line UVLO. If desired to achieve a UVLO voltage, a resistor divider from Vin to ON/OFF to GND can be used to disable the converter until a higher input voltage is achieved. For example, it is not useful for a converter with 12V output to start up with a 12V input, as the output cannot reach regulation. To enable the converter when the input voltage reaches 14V, a 51kΩ/5kΩ voltage divider from Vin to GND can be connected to the ON/OFF pin. Both the precision 1.25V threshold and 150mV hysteresis are multiplied by the resistor ratio, providing a proportional 12% hysteresis for any startup threshold. So, the turn off threshold would be between 12.3V to 15.7V.

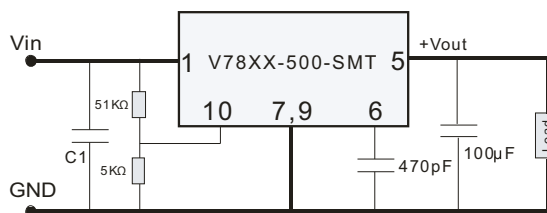

- 3) Power supply sequencing. By connecting a small capacitor from ON/OFF to GND, the 2µA current source and 1.25V threshold can provide a stable and predictable delay between startup of multiple power supplies. For example, a startup delay of roughly 64mS is provided using 100nF, and roughly 136mS by using 200nF.

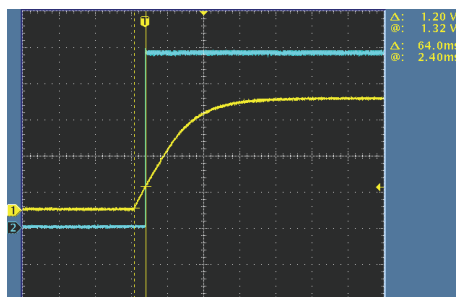
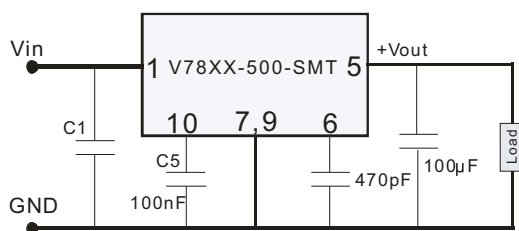

CH1: Von/off  
CH2: Vo  
Delay time: 64mS

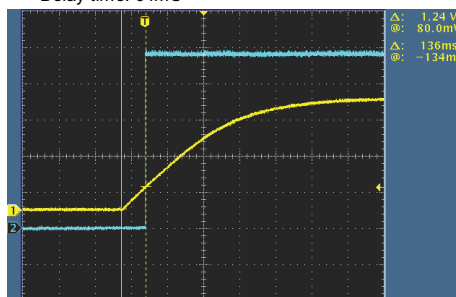
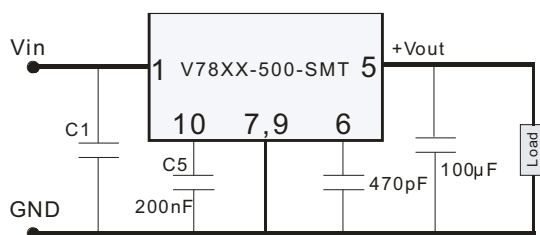

CH1: Von/off  
CH2: Vo  
Delay time: 136mS