

PART NUMBER: V78XX-500 series

DESCRIPTION: DC switching regulator, non-isolated

description

The V78XX series of switching regulators are designed to replace 78XX linear regulators, with the objective of drop-in replacement without the need for a heatsink, because the V78XX series features high efficiency under all line conditions. Built-in short-circuit and over-temperature protections ensure very rugged operations. Additionally, low ripple and noise performance make the parts useful in a wide range of applications.

features

- efficiency up to 96%
- no need for heatsinks
- wide input range
- short circuit protection
- thermal shutdown
- low ripple and noise
- pin compatible to LM78XX series
- non-isolated



model number	input voltage range	output voltage	output current	efficiency	
				Vin_min	Vin_max
V7803-500	4.75~28 Vdc	3.3 Vdc	500 mA	90%	80%
V7805-500	6.5~32 Vdc	5 Vdc	500 mA	93%	84%
V7806-500	8~32 Vdc	6.5 Vdc	500 mA	94%	87%
V7809-500	11~32 Vdc	9 Vdc	500 mA	95%	91%
V7812-500	15~32 Vdc	12 Vdc	500 mA	95%	92%
V7815-500	18~32 Vdc	15 Vdc	500 mA	96%	93%

*see Application Notes section (page 5) for positive to negative conversion options.

OUTPUT SPECIFICATIONS

item	conditions	min.	typ.	max.	unit
output voltage accuracy	at 100% load		±2	±3	%
line regulation	Vin = min. to max. at full load		±0.2	±0.4	%
load regulation	10% to 100% full load		±0.4	±0.6	%
output ripple	20 MHz bandwidth, output w/ 10µF cap		20	35	mVp-p
short circuit protection	continuous, auto recovery upon removal of short				
short circuit input power	load impedance is ≤ 0.1Ω		0.3	0.8	W
output current limit	subject to over-temp shutdown			2000	mA
switching frequency	fixed switching frequency topology	280	330	450	KHz
dynamic load stability	100% ↔ 10% load			±100	mV
quiescent current	Vin_min to Vin_max at no load		5	7	mA
thermal shutdown	internal IC junction		150		°C
temperature coefficient	-40°C ~ 85°C ambient			0.02	%/°C
max load capacitance				1000	µF

GENERAL SPECIFICATIONS

item	conditions	min.	typ.	max.	unit
operating temperature range	see derating curve	-40		85	°C
operating case temperature		-40		100	°C
storage temperature range		-55		125	°C
cooling	free air convection				
solderability	1.5 mm from case for 10 seconds			300	°C
storage humidity range	relative humidity, non-condensing	10		95	%
case material	plastic (UL94-V0)				
case thermal impedance				70	°C/W
MTBF	at 25°C per MIL-HDBK-217F	2,000,000			hours
package weight			2.0		grams

PART NUMBER: V78XX-500 series

DESCRIPTION: DC switching regulator, non-isolated

MECHANICAL DRAWINGS

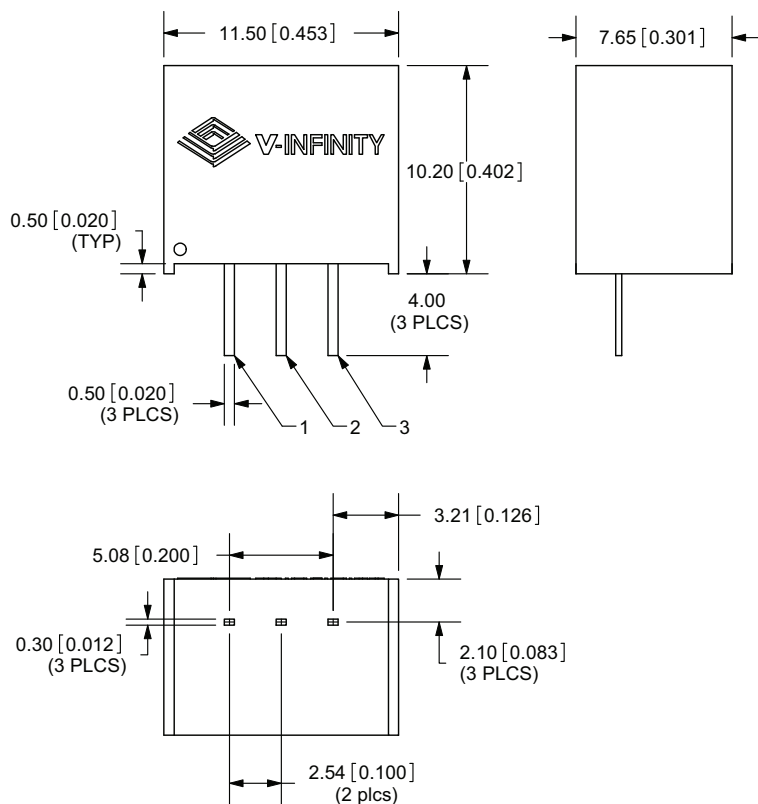

Recommended PCB Layout Pattern

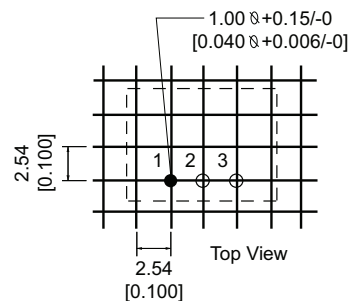

PIN	ASSIGNMENTS
1	+Vin
2	GND
3	+Vout

units: mm(inches)
pin tolerances: $\pm 0.10(\pm 0.004)$
general tolerances: $\pm 0.25(\pm 0.01)$

THERMAL DERATING CURVE

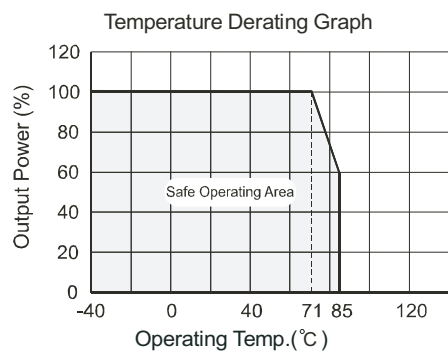

PART NUMBER: V78XX-500 series

DESCRIPTION: DC switching regulator, non-isolated

TYPICAL APPLICATION CIRCUIT

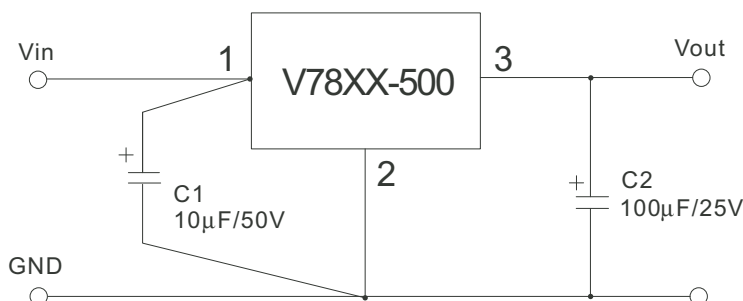

INPUT CAPACITOR (C1):

A low ESR capacitor is recommended to keep the noise at the converter to a minimum. Ceramic capacitors are preferred but tantalum or low ESR electrolytic capacitors may also suffice. Place C1 as close as possible to pins 1 & 2.

OUTPUT CAPACITOR (C2):

A 100µF/25V electrolytic capacitor is recommended.

TEST CIRCUIT

FOR EFFICIENCY & RIPPLE GRAPHS (PAGE4)

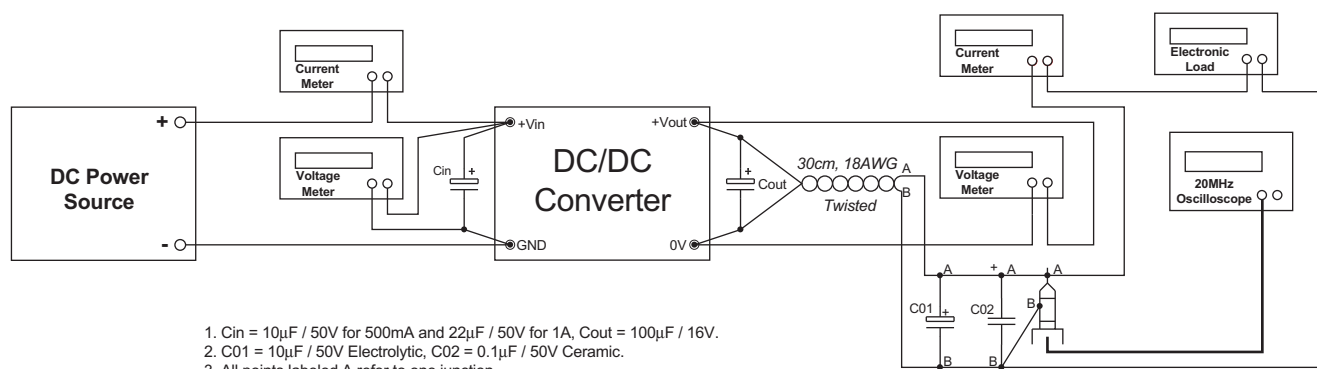

1. Cin = 10µF / 50V for 500mA and 22µF / 50V for 1A, Cout = 100µF / 16V.
2. C01 = 10µF / 50V Electrolytic, C02 = 0.1µF / 50V Ceramic.
3. All points labeled A refer to one junction.
4. All points labeled B refer to one junction.
5. Use a short ground loop for probing. Do not use a wired ground clip.

PART NUMBER: V78XX-500 series

DESCRIPTION: DC switching regulator, non-isolated

EFFICIENCY AND RIPPLE

Efficiency

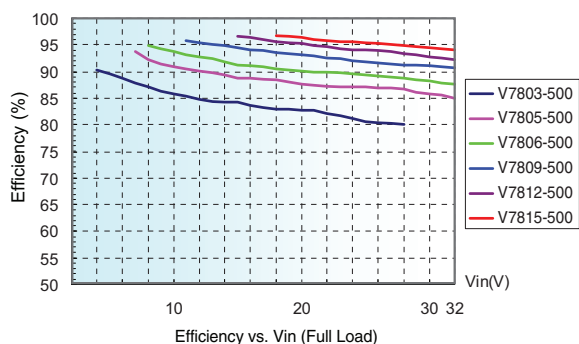

Output Ripple

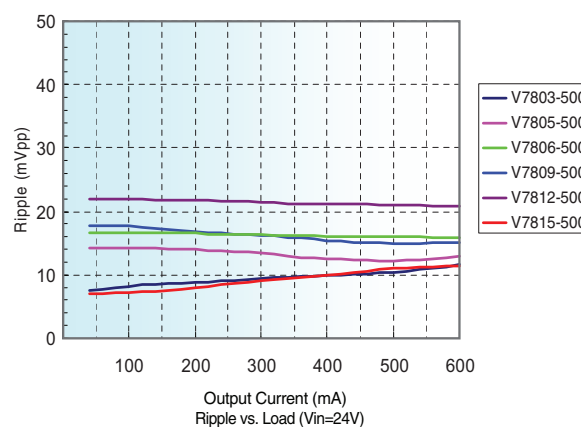
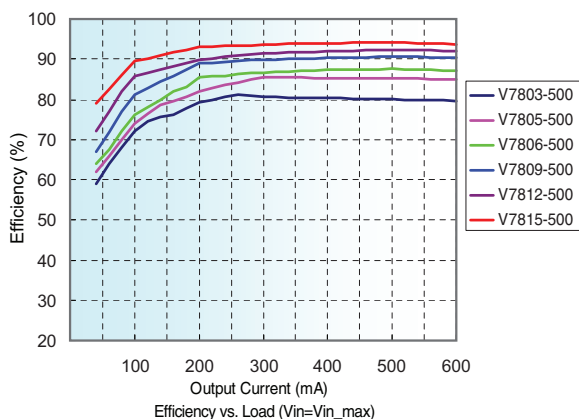
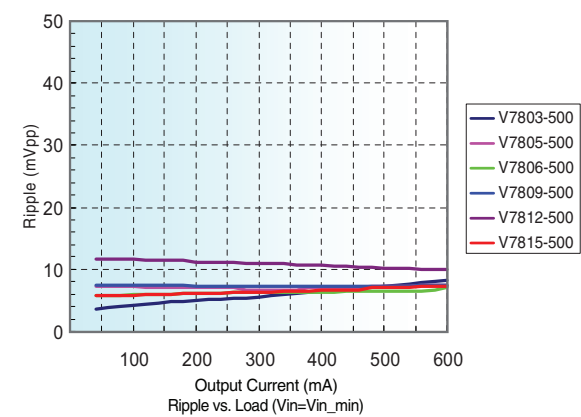
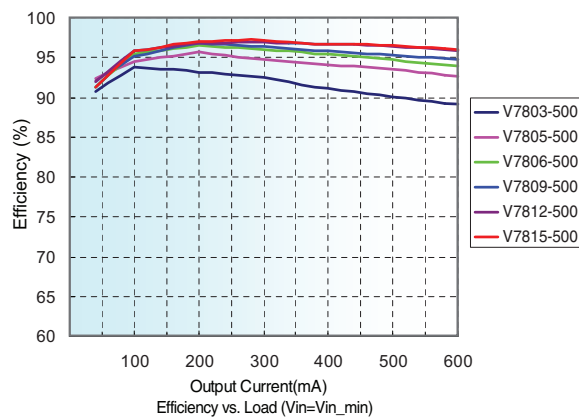
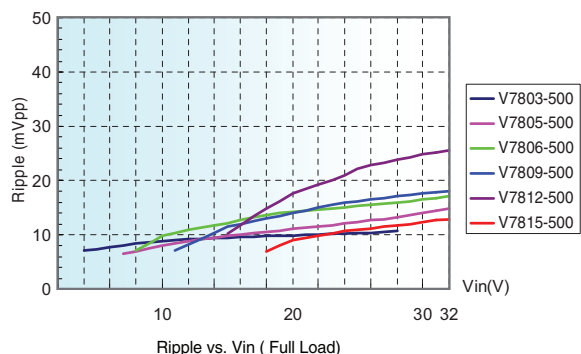

PART NUMBER: V78XX-500 series

DESCRIPTION: DC switching regulator, non-isolated

APPLICATION NOTES: Positive to Negative conversion option
application

The V78XX-500 series converters can also be used to convert a positive voltage into a negative voltage with only two extra capacitors needed.

model number	input voltage range	output voltage	output current	efficiency	
				Vin_min	Vin_max
V7803-500	4.75~25 Vdc	-3.3 Vdc	400 mA	73%	78%
V7805-500	6~27 Vdc	-5 Vdc	400 mA	76%	83%
V7806-500	6~25 Vdc	-6.5 Vdc	300 mA	83%	85%
V7809-500	7~23 Vdc	-9 Vdc	200 mA	87%	86%
V7812-500	7~20 Vdc	-12 Vdc	200 mA	85%	87%
V7815-500	7~17 Vdc	-15 Vdc	200 mA	84%	89%

OUTPUT SPECIFICATIONS

item	conditions	min.	typ.	max.	unit
output voltage accuracy	at 100% load		±2	±3	%
line regulation	Vin = min. to max. at full load		±0.2	±0.4	%
load regulation	10% to 100% full load		±0.4	±0.6	%
output ripple	20 MHz bandwidth, output w/ 10µF cap		20	35	mVp-p
short circuit protection	continuous, auto recovery upon removal of short				
short circuit input power			0.5	1.2	W
switching frequency	fixed switching frequency topology	280	330	450	KHz
dynamic load stability	100%↔10% load			±100	mV
quiescent current	Vin_min to Vin_max at no load		7	10	mA
thermal shutdown	internal IC junction		150		°C
temperature coefficient	-40°C ~ 85°C ambient			0.02	%/°C
max load capacitance				1000	µF

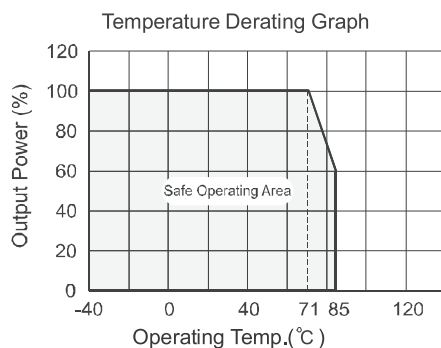
TYPICAL CHARACTERISTICS

PART NUMBER: V78XX-500 series

DESCRIPTION: DC switching regulator, non-isolated

TYPICAL APPLICATION CIRCUITS

1. Negative output

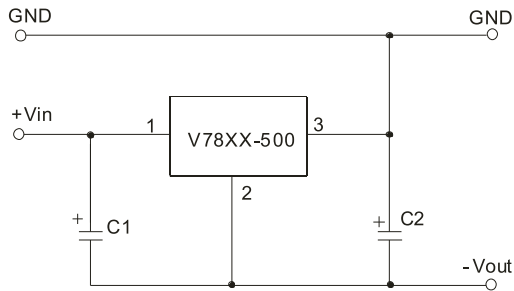

2. Positive and Negative outputs

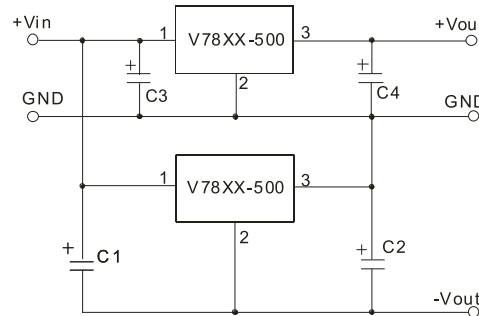

Note:

1. C1 and C2 are required and should be fitted close to the converter pins.
2. For the capacitance of C1 and C2, see the external capacitor table. Low ESR types should be chosen.
3. C3: a low ESR capacitor is required to keep the noise at the converter to a minimum. Ceramic capacitors are preferred, but tantalum or low ESR electrolytic capacitors may also suffice; General used 10µF/50V ceramic capacitor. C4 Optional, General used 100µF/25V electrolytic capacitor.
4. No parallel connection or plug and play.

EXTERNAL CAPACITOR TABLE

Part Number	C1	C2
V7803-500	10µF/50V	22µF/6.3V
V7805-500	10µF/50V	22µF/10V
V7806-500	10µF/50V	10µF/10V
V7809-500	10µF/50V	10µF/16V
V7812-500	10µF/50V	10µF/25V
V7815-500	10µF/50V	10µF/25V