

QHW050F1-Q, QHW075F1-Q, and QHW100F1-Q Power Modules; dc-dc Converters: 36 to 75 Vdc Input, 3.3 Vdc Output; 33 W to 66 W

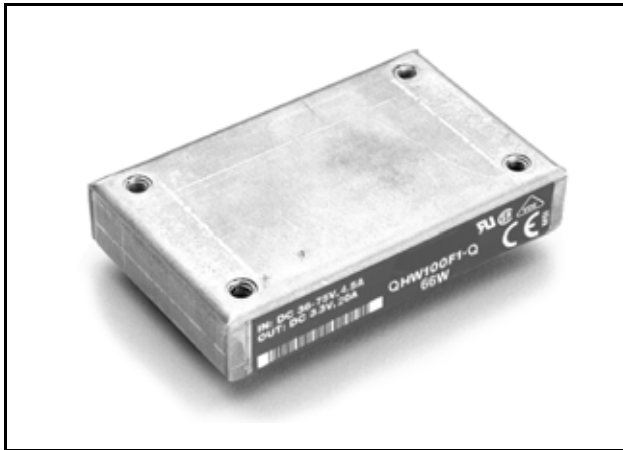

The QHW Series Power Modules use advanced, surface-mount technology and deliver high-quality, efficient, and compact dc-dc conversion.

Applications

- Distributed power architectures
- Communications equipment
- Computer equipment

Options

- Heat sinks available for extended operation
- Auto-restart after overtemperature, overvoltage, or overcurrent shutdown
- Choice of short pin lengths
- Case ground pin

Description

The QHW050F1-Q, QHW075F1-Q, and QHW100F1-Q Power Modules are dc-dc converters that operate over an input voltage range of 36 Vdc to 75 Vdc and provide a precisely regulated dc output. The outputs are fully isolated from the inputs, allowing versatile polarity configurations and grounding connections. The modules have maximum power ratings from 33 W to 66 W at a typical full-load efficiency of 85%.

The sealed modules offer a metal baseplate for excellent thermal performance. Threaded-through holes are provided to allow easy mounting or addition of a heat sink for high-temperature applications. The standard feature set includes remote sensing, output trim, and remote on/off for convenient flexibility in distributed power applications.

Features

- Small size: 36.8 mm x 57.9 mm x 12.7 mm (1.45 in. x 2.28 in. x 0.50 in.)
- High power density
- Extra high efficiency: 85% typical
- Low output noise
- Constant frequency
- Industry-standard pinout
- Metal baseplate
- 2:1 input voltage range
- Overvoltage and overcurrent, overtemperature protection
- Negative remote on/off
- Remote sense
- Adjustable output voltage
- ISO* 9001 and ISO 14001 Certified manufacturing facilities
- UL†60950 Recognized, CSA‡ C22.2 No. 60950-00 Certified, and VDE§ 0805 (EN60950) Licensed
- CE mark meets 73/23/EEC and 93/68/EEC directives**

* ISO is a registered trademark of the International Organization for Standardization.

† UL is a registered trademark of Underwriters Laboratories, Inc.

‡ CSA is a registered trademark of Canadian Standards Association.

§ VDE is a trademark of Verband Deutscher Elektrotechniker e.V.

** This product is intended for integration into end-use equipment. All the required procedures for CE marking of end-use equipment should be followed. (The CE mark is placed on selected products.)

Absolute Maximum Ratings

Stresses in excess of the absolute maximum ratings can cause permanent damage to the device. These are absolute stress ratings only. Functional operation of the device is not implied at these or any other conditions in excess of those given in the operations sections of the data sheet. Exposure to absolute maximum ratings for extended periods can adversely affect device reliability.

Parameter	Symbol	Min	Max	Unit
Input Voltage:				
Continuous	V_I	—	75	Vdc
Transient (100 ms)	$V_{I, trans}$	—	100	V
Operating Case Temperature (See Thermal Considerations section.)	T_C	-40	100	°C
Storage Temperature	T_{stg}	-55	125	°C
I/O Isolation Voltage (for 1 minute)	—	—	1500	Vdc

Electrical Specifications

Unless otherwise indicated, specifications apply over all operating input voltage, resistive load, and temperature conditions.

Table 1. Input Specifications

Parameter	Symbol	Min	Typ	Max	Unit
Operating Input Voltage	V_I	36	48	75	Vdc
Maximum Input Current:					
$V_I = 0\text{ V to }75\text{ V}; I_O = I_{O, max};$ see Figures 1—3:					
QHW050F1-Q	$I_{I, max}$	—	—	2.5	A
QHW075F1-Q	$I_{I, max}$	—	—	3.5	A
QHW100F1-Q	$I_{I, max}$	—	—	4.5	A
$V_I = 36\text{ V to }75\text{ V}; I_O = I_{O, max};$					
QHW050F1-Q	$I_{I, max}$	—	—	1.9	A
QHW050F1-Q	$I_{I, max}$	—	—	2.7	A
QHW075F1-Q	$I_{I, max}$	—	—	3.5	A
Inrush Transient	i^2t	—	—	1.0	A ² s
Input Reflected-ripple Current, Peak-to-peak (5 Hz to 20 MHz, 12 μ H source impedance; see Figure 17.)	I_I	—	10	—	mAp-p
Input Ripple Rejection (120 Hz)	—	—	60	—	dB

Fusing Considerations

CAUTION: This power module is not internally fused. An input line fuse must always be used.

This encapsulated power module can be used in a wide variety of applications, ranging from simple stand-alone operation to an integrated part of a sophisticated power architecture. To preserve maximum flexibility, internal fusing is not included; however, to achieve maximum safety and system protection, always use an input line fuse. The safety agencies require a normal-blow fuse with a maximum rating of 20 A (see Safety Considerations section). Based on the information provided in this data sheet on inrush energy and maximum dc input current, the same type of fuse with a lower rating can be used. Refer to the fuse manufacturer's data for further information.

Electrical Specifications (continued)

Table 2. Output Specifications

Parameter	Device	Symbol	Min	Typ	Max	Unit
Output Voltage Set Point ($V_I = 48\text{ V}$; $I_O = I_{O, \text{max}}$; $T_C = 25\text{ }^\circ\text{C}$)	All	$V_{O, \text{set}}$	3.24	3.3	3.36	Vdc
Output Voltage (Over all operating input voltage, resistive load, and temperature conditions until end of life. See Figure 19.)	All	V_O	3.2	—	3.4	Vdc
Output Regulation: Line ($V_I = 36\text{ V}$ to 75 V)	All	—	—	0.01 [‡]	0.1 [‡]	% V_O
Load ($I_O = I_{O, \text{min}}$ to $I_{O, \text{max}}$)	All	—	—	0.05	0.2	% V_O
Temperature ($T_C = -40\text{ }^\circ\text{C}$ to $+100\text{ }^\circ\text{C}$)	All	—	—	15 [‡]	50 [‡]	mV
Output Ripple and Noise Voltage (See Figure 18.): RMS	All	—	—	—	40	mVrms
Peak-to-peak (5 Hz to 20 MHz)	All	—	—	—	150	mVp-p
External Load Capacitance	All	—	0	—	*	μF
Output Current (At $I_O < I_{O, \text{min}}$, the modules may exceed output ripple specifications.)	QHW050F1-Q	I_O	0.5	—	10	A
	QHW075F1-Q	I_O	0.5	—	15	A
	QHW100F1-Q	I_O	0.5	—	20	A
Output Current-limit Inception ($V_O = 90\%$ of $V_{O, \text{nom}}$)	QHW050F1-Q	$I_{O, \text{cli}}$	—	15	20 [†]	A
	QHW075F1-Q	$I_{O, \text{cli}}$	—	20	26 [†]	A
	QHW100F1-Q	$I_{O, \text{cli}}$	—	25	32 [†]	A
Efficiency ($V_I = 48\text{ V}$; $I_O = I_{O, \text{max}}$; $T_C = 70\text{ }^\circ\text{C}$; see Figure 19.)	QHW050F1-Q	η	—	85	—	%
	QHW075F1-Q	η	—	85.5	—	%
	QHW100F1-Q	η	—	84.5	—	%
Switching Frequency	All	—	—	380	—	kHz
Dynamic Response ($\Delta I_O/\Delta t = 1\text{ A}/10\text{ }\mu\text{s}$, $V_I = 48\text{ V}$, $T_C = 25\text{ }^\circ\text{C}$; tested with a 1000 μF aluminum and a 1.0 μF ceramic capacitor across the load): Load Change from $I_O = 50\%$ to 75% of $I_{O, \text{max}}$: Peak Deviation	All	—	—	6	—	% $V_{O, \text{set}}$
Settling Time ($V_O < 10\%$ of peak deviation)	All	—	—	200	—	μs
Load Change from $I_O = 50\%$ to 25% of $I_{O, \text{max}}$: Peak Deviation	All	—	—	6	—	% $V_{O, \text{set}}$
Settling Time ($V_O < 10\%$ of peak deviation)	All	—	—	200	—	μs

* Consult your sales representative or the factory.

† These are manufacturing test limits. In some situations, results may differ.

‡ Total tolerance may be tighter than specified under various line, load or ambient condition.

n For a reduced line range of 44 to 52 volts: line regulation = $\pm 3\text{ mV}/\pm 7\text{ mV}$

n For a case temperature range of 30 to 55 $^\circ\text{C}$: temperature drift = 20 mV

Table 3. Isolation Specifications

Parameter	Min	Typ	Max	Unit
Isolation Capacitance	—	2500	—	pF
Isolation Resistance	10	—	—	$\text{M}\Omega$

General Specifications

Parameter	Min	Typ	Max	Unit
Calculated MTBF ($I_o = 80\%$ of $I_{o, max}$; $T_c = 40\text{ }^\circ\text{C}$)	2,200,000			hours
Weight	—	—	75 (2.7)	g (oz.)

Feature Specifications

Unless otherwise indicated, specifications apply over all operating input voltage, resistive load, and temperature conditions. See the Feature Descriptions section for additional information.

Parameter	Symbol	Min	Typ	Max	Unit
Remote On/Off Signal Interface ($V_i = 0\text{ V}$ to 75 V ; open collector or equivalent compatible; signal referenced to $V_i(-)$ terminal): Logic Low—Module On Logic High—Module Off Logic Low: At $I_{on/off} = 1.0\text{ mA}$ At $V_{on/off} = 0.0\text{ V}$ Logic High: At $I_{on/off} = 0.0\text{ }\mu\text{A}$ Leakage Current Turn-on Time (See Figure 16.) ($I_o = 80\%$ of $I_{o, max}$; V_o within $\pm 1\%$ of steady state)	$V_{on/off}$ $I_{on/off}$ $V_{on/off}$ $I_{on/off}$ —	0 — — — —	— — — — 20	1.2 1.0 15 50 35	V mA V μA ms
Output Voltage Adjustment: Output Voltage Remote-sense Range Output Voltage Set-point Adjustment Range (trim)	— —	— 90	— —	0.5 110	V $\%V_{o, nom}$
Output Overvoltage Protection	$V_{o, sd}$	3.8*	—	4.5*	V
Overtemperature Protection	T_c	—	105	—	$^\circ\text{C}$

* These are manufacturing test limits. In some situations, results may differ.

Solder, Cleaning, and Drying Considerations

Post solder cleaning is usually the final circuit-board assembly process prior to electrical testing. The result of inadequate circuit-board cleaning and drying can affect both the reliability of a power module and the testability of the finished circuit-board assembly. For guidance on appropriate soldering, cleaning, and drying procedures, refer to Lineage Power *Board-Mounted Power Modules Soldering and Cleaning Application Note* (AP97-021EPS).

Characteristic Curves

The following figures provide typical characteristics for the power modules.

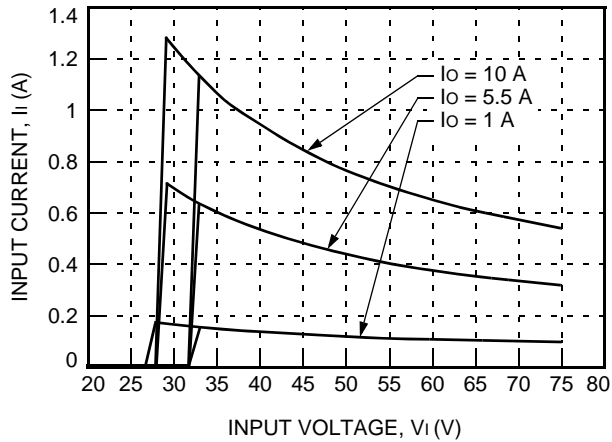

8-3261(F)

Figure 1. Typical QHW050F1-Q Input Characteristics at Room Temperature

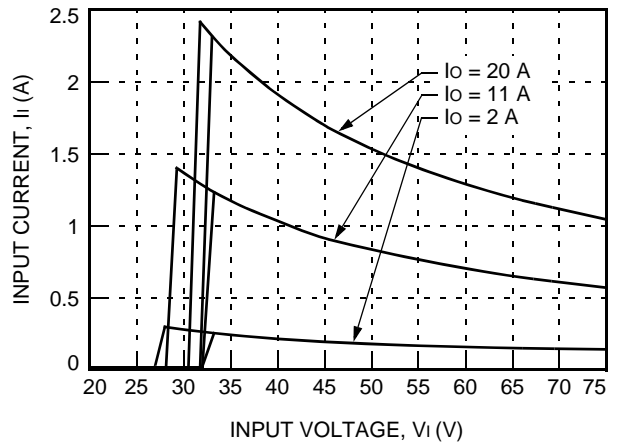

8-3262(F)

Figure 3. Typical QHW100F1-Q Input Characteristics at Room Temperature

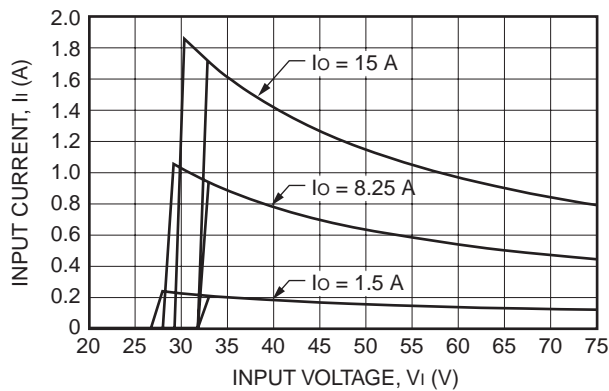

1-0038

Figure 2. Typical QHW075F1-Q Input Characteristics at Room Temperature

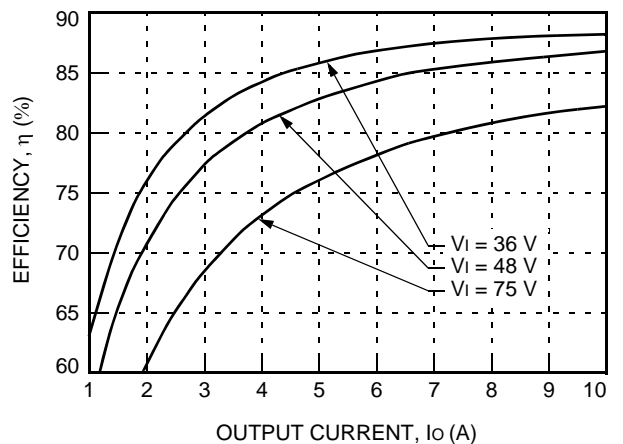

8-3263(F)

Figure 4. Typical QHW050F1-Q Converter Efficiency vs. Output Current at Room Temperature

Characteristic Curves (continued)

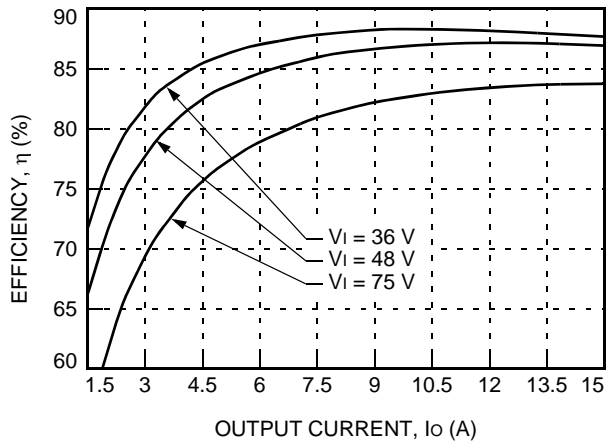

8-3455(F)

Figure 5. Typical QHW075F1-Q Converter Efficiency vs. Output Current at Room Temperature

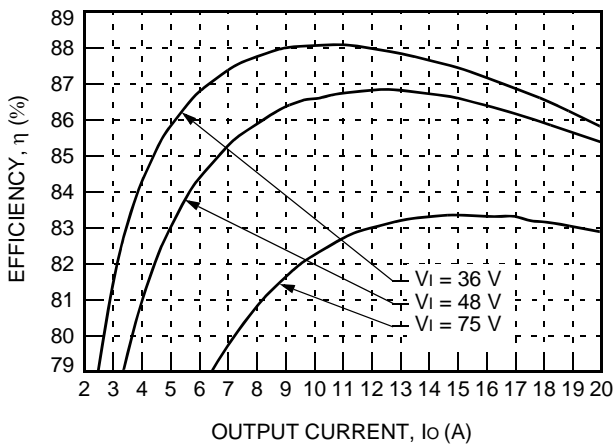

8-3264(F)

Figure 6. Typical QHW100F1-Q Converter Efficiency vs. Output Current at Room Temperature

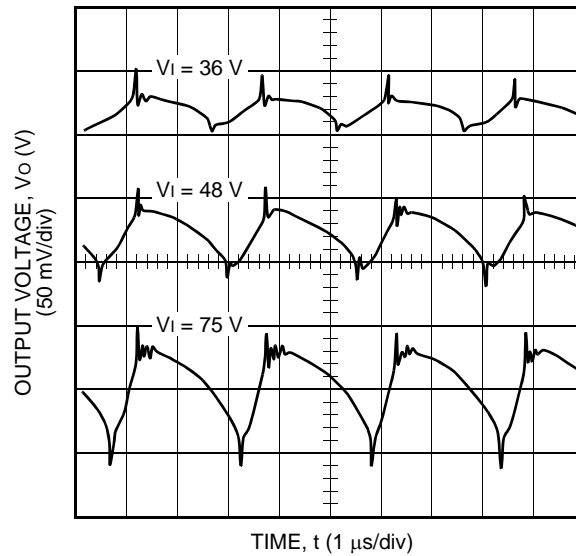

8-3265(F)

Note: See Figure 18 for test conditions.

Figure 7. Typical QHW050F1-Q Output Ripple Voltage at Room Temperature; $I_o = I_{o, max}$

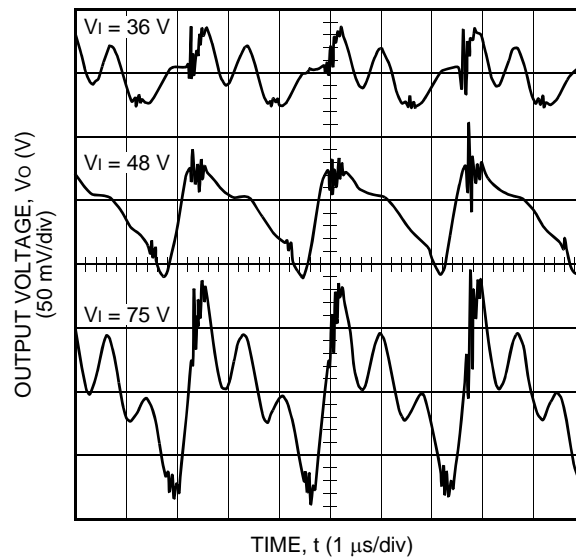

8-3456(F)

Note: See Figure 18 for test conditions.

Figure 8. Typical QHW075F1-Q Output Ripple Voltage at Room Temperature; $I_o = I_{o, max}$

Characteristic Curves (continued)

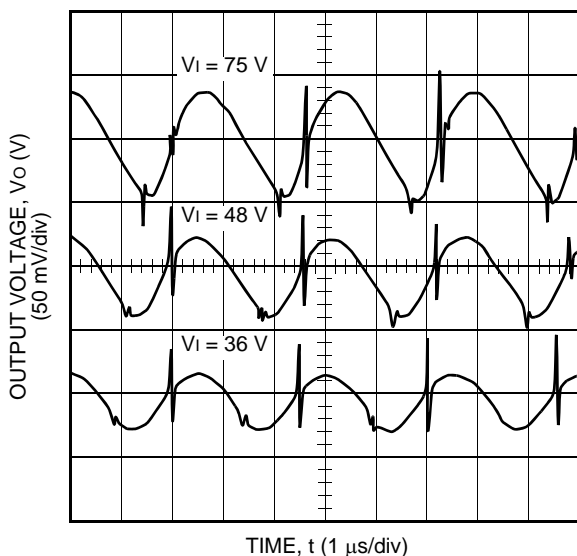

8-3266(C)

Note: See Figure 18 for test conditions.

Figure 9. Typical QHW100F1-Q Output Ripple Voltage at Room Temperature; $I_o = I_{o, max}$

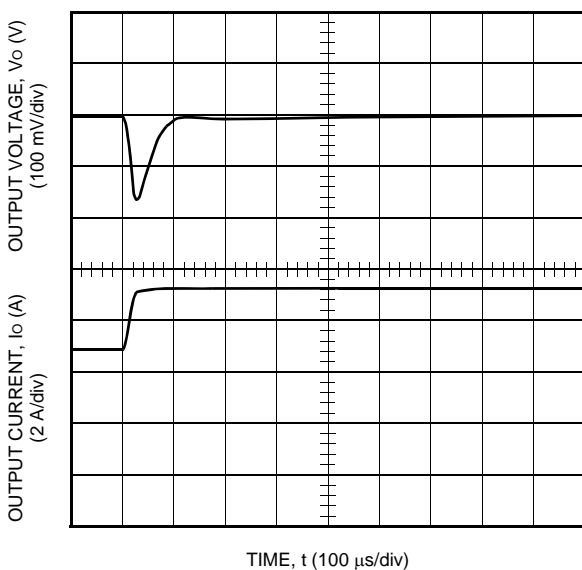

8-3267(F)

Note: Tested with a 1000 μ F aluminum and a 1.0 μ F ceramic capacitor across the load.

Figure 10. Typical QHW050F1-Q Transient Response to Step Increase in Load from 50% to 75% of Full Load at Room Temperature and 48 Vdc Input. (Waveform Averaged to Eliminate Ripple Component.)

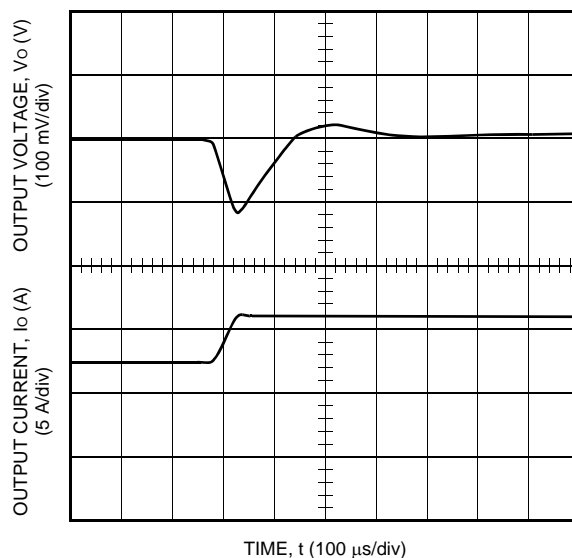

8-3457(F)

Note: Tested with a 1000 μ F aluminum and a 1.0 μ F ceramic capacitor across the load.

Figure 11. Typical QHW075F1-Q Transient Response to Step Increase in Load from 50% to 75% of Full Load at Room Temperature and 36 Vdc Input. (Waveform Averaged to Eliminate Ripple Component.)

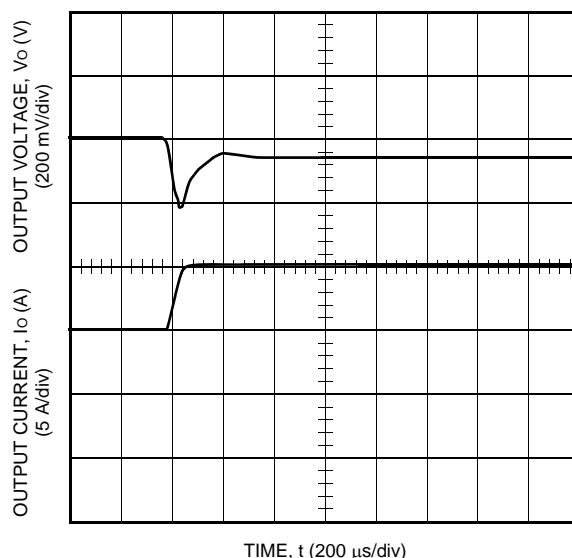

8-3268(F)

Note: Tested with a 1000 μ F aluminum and a 1.0 μ F ceramic capacitor across the load.

Figure 12. Typical QHW100F1-Q Transient Response to Step Increase in Load from 50% to 75% of Full Load at Room Temperature and 48 Vdc Input. (Waveform Averaged to Eliminate Ripple Component.)

Characteristic Curves (continued)

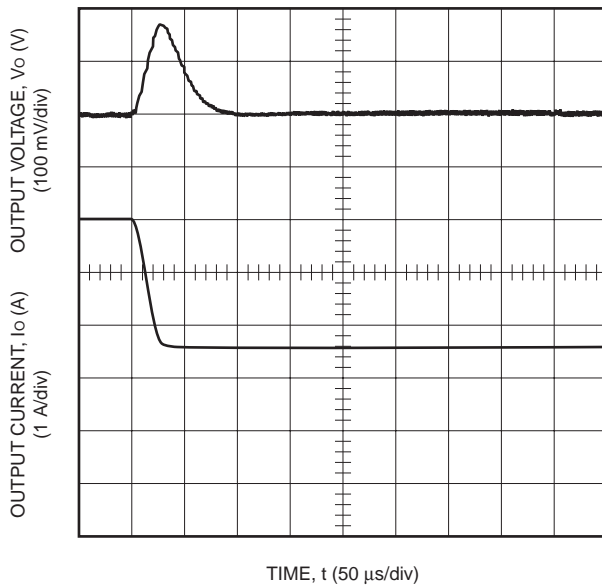

1-0088
Note: Tested with a 1000 μ F aluminum and a 1.0 μ F ceramic capacitor across the load.

Figure 13. Typical QHW050F1-Q Transient Response to Step Decrease in Load from 50% to 25% of Full Load at Room Temperature and 48 Vdc Input. (Waveform Averaged to Eliminate Ripple Component.)

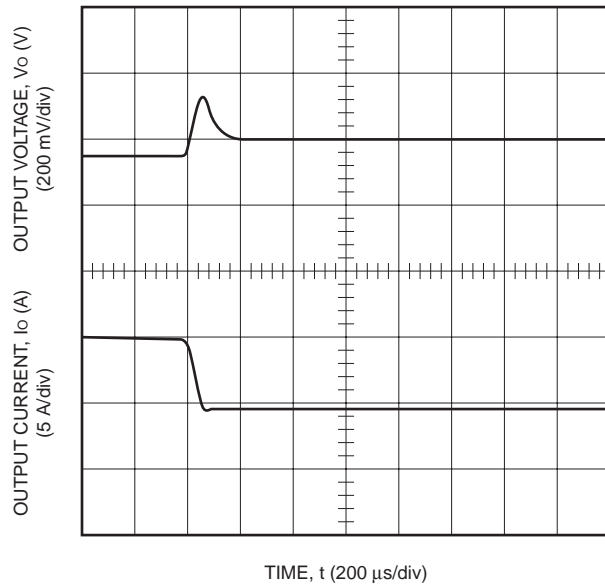

1-0089
Note: Tested with a 1000 μ F aluminum and a 1.0 μ F ceramic capacitor across the load.

Figure 15. Typical QHW100F1-Q Transient Response to Step Decrease in Load from 50% to 25% of Full Load at Room Temperature and 48 Vdc Input. (Waveform Averaged to Eliminate Ripple Component.)

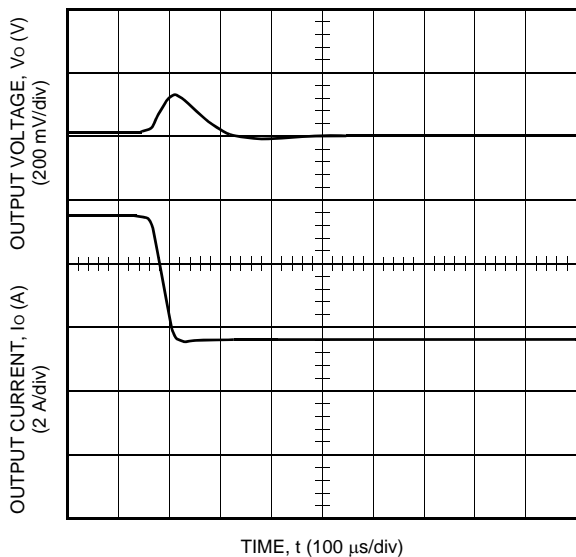

8-3458(F)
Note: Tested with a 1000 μ F aluminum and a 1.0 μ F ceramic capacitor across the load.

Figure 14. Typical QHW075F1-Q Transient Response to Step Decrease in Load from 50% to 25% of Full Load at Room Temperature and 48 Vdc Input. (Waveform Averaged to Eliminate Ripple Component.)

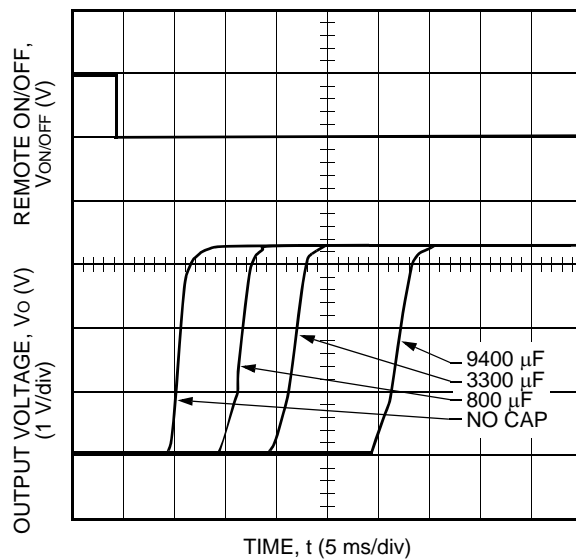

8-3269(F)
Figure 16. Typical Start-Up from Remote On/Off; $I_o = I_{o, max}$

Test Configurations

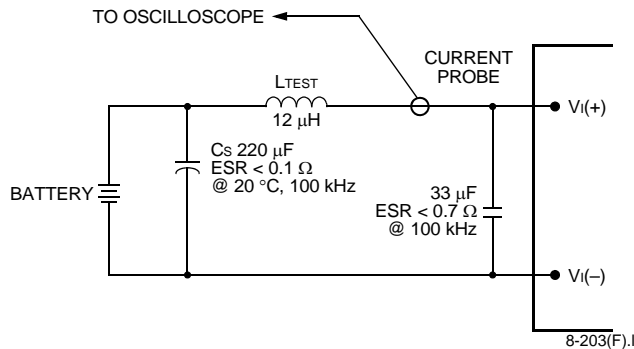

Note: Measure input reflected-ripple current with a simulated source inductance (L_{TEST}) of 12 μH . Capacitor C_S offsets possible battery impedance. Measure current as shown above.

Figure 17. Input Reflected-Ripple Test Setup

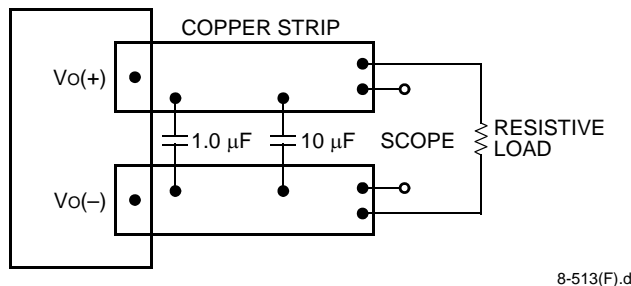

Note: Use a 1.0 μF ceramic capacitor and a 10 μF aluminum or tantalum capacitor. Scope measurement should be made using a BNC socket. Position the load between 51 mm and 76 mm (2 in. and 3 in.) from the module.

Figure 18. Peak-to-Peak Output Noise Measurement Test Setup

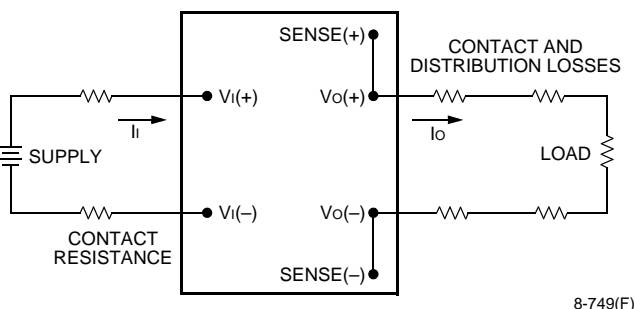

Note: All measurements are taken at the module terminals. When socketing, place Kelvin connections at module terminals to avoid measurement errors due to socket contact resistance.

$$\eta = \left(\frac{[V_{O(+)} - V_{O(-)}] I_o}{[V_{I(+)} - V_{I(-)}] I_i} \right) \times 100 \quad \%$$

Figure 19. Output Voltage and Efficiency Measurement Test Setup

Lineage Power

Design Considerations

Input Source Impedance

The power module should be connected to a low ac-impedance input source. Highly inductive source impedances can affect the stability of the power module. For the test configuration in Figure 17, a 33 μF electrolytic capacitor (ESR < 0.7 Ω at 100 kHz) mounted close to the power module helps ensure stability of the unit. For other highly inductive source impedances, consult the factory for further application guidelines.

Safety Considerations

For safety-agency approval of the system in which the power module is used, the power module must be installed in compliance with the spacing and separation requirements of the end-use safety agency standard, i.e., *UL60950*, *CSA C22.2 No. 60950-00*, and *VDE 0805 (EN60950)*.

If the input source is non-SELV (ELV or a hazardous voltage greater than 60 Vdc and less than or equal to 75 Vdc), for the module's output to be considered meeting the requirements of safety extra-low voltage (SELV), all of the following must be true:

- The input source are to be provided with reinforced insulation from any hazardous voltages, including the ac mains.
- One V_I pin and one V_O pin are to be grounded, or both the input and output pins are to be kept floating.
- The input pins of the module are not operator accessible.
- Another SELV reliability test is conducted on the whole system, as required by the safety agencies, on the combination of supply source and the subject module to verify that under a single fault, hazardous voltages do not appear at the module's output.

Note: Do not ground either of the input pins of the module without grounding one of the output pins. This may allow a non-SELV voltage to appear between the output pin and ground.

The power module has extra-low voltage (ELV) outputs when all inputs are ELV.

The input to these units is to be provided with a maximum 20 A normal-blow fuse in the ungrounded lead.

Feature Descriptions

Overcurrent Protection

To provide protection in a fault (output overload) condition, the unit is equipped with internal current-limiting circuitry and can endure current limiting for up to one second. If overcurrent exists for more than one second, the unit will shut down.

At the point of current-limit inception, the unit shifts from voltage control to current control. If the output voltage is pulled very low during a severe fault, the current-limit circuit can exhibit either foldback or tailout characteristics (output current decrease or increase).

The module is available in two overcurrent configurations. In one configuration, when the unit shuts down it will latch off. The overcurrent latch is reset by either cycling the input power or by toggling the ON/OFF pin for one second. In the other configuration, the unit will try to restart after shutdown. If the output overload condition still exists when the unit restarts, it will shut down again. This operation will continue indefinitely until the overcurrent condition is corrected.

Remote On/Off

Negative logic remote on/off turns the module off during a logic high and on during a logic low. To turn the power module on and off, the user must supply a switch to control the voltage between the on/off terminal and the $V_I(-)$ terminal ($V_{on/off}$). The switch can be an open collector or equivalent (see Figure 20). A logic low is $V_{on/off} = 0$ V to 1.2 V. The maximum $I_{on/off}$ during a logic low is 1 mA. The switch should maintain a logic-low voltage while sinking 1 mA.

During a logic high, the maximum $V_{on/off}$ generated by the power module is 15 V. The maximum allowable leakage current of the switch at $V_{on/off} = 15$ V is 50 μ A.

If not using the remote on/off feature, short the ON/OFF pin to $V_I(-)$.

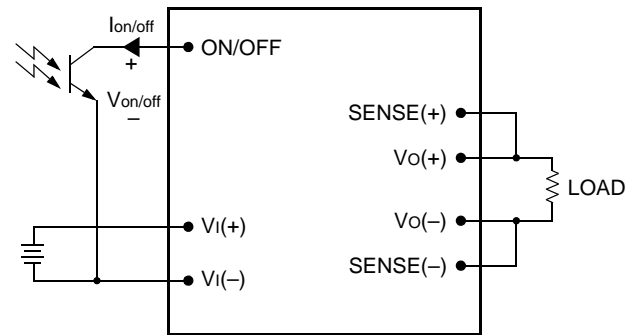

8-720(F).c

Figure 20. Remote On/Off Implementation

Remote Sense

Remote sense minimizes the effects of distribution losses by regulating the voltage at the remote-sense connections. The voltage between the remote-sense pins and the output terminals must not exceed the output voltage sense range given in the Feature Specifications table, i.e.:

$$[V_o(+)-V_o(-)]-[SENSE(+)-SENSE(-)]\leq 0.5\text{ V}$$

The voltage between the $V_o(+)$ and $V_o(-)$ terminals must not exceed the minimum output overvoltage protection value shown in the Feature Specifications table. This limit includes any increase in voltage due to remote-sense compensation and output voltage set-point adjustment (trim). See Figure 21.

If not using the remote-sense feature to regulate the output at the point of load, then connect SENSE(+) to $V_o(+)$ and SENSE(-) to $V_o(-)$ at the module.

Although the output voltage can be increased by both the remote sense and by the trim, the maximum increase for the output voltage is not the sum of both. The maximum increase is the larger of either the remote sense or the trim. Consult the factory if you need to increase the output voltage more than the above limitation.

The amount of power delivered by the module is defined as the voltage at the output terminals multiplied by the output current. When using remote sense and trim, the output voltage of the module can be increased, which at the same output current would increase the power output of the module. Care should be taken to ensure that the maximum output power of the module remains at or below the maximum rated power.

Feature Descriptions (continued)

Remote Sense (continued)

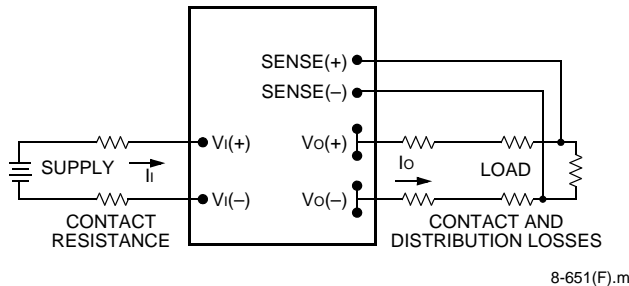

Figure 21. Effective Circuit Configuration for Single-Module Remote-Sense Operation

Output Voltage Set-Point Adjustment (Trim)

Output voltage trim allows the user to increase or decrease the output voltage set point of a module. This is accomplished by connecting an external resistor between the TRIM pin and either the SENSE(+) or SENSE(-) pins. The trim resistor should be positioned close to the module.

If not using the trim feature, leave the TRIM pin open.

With an external resistor between the TRIM and SENSE(-) pins ($R_{\text{adj-down}}$), the output voltage set point ($V_{O, \text{adj}}$) decreases (see Figure 22). The following equation determines the required external-resistor value to obtain a percentage output voltage change of $\Delta\%$.

$$R_{\text{adj-down}} = \left(\frac{510}{\Delta\%} - 10.2 \right) \text{ k}\Omega$$

With an external resistor connected between the TRIM and SENSE(+) pins ($R_{\text{adj-up}}$), the output voltage set point ($V_{O, \text{adj}}$) increases (see Figure 23).

The following equation determines the required external-resistor value to obtain a percentage output voltage change of $\Delta\%$.

$$R_{\text{adj-up}} = \left(\frac{5.1V_O(100 + \Delta\%)}{1.225\Delta\%} - \frac{510}{\Delta\%} - 10.2 \right) \text{ k}\Omega$$

The voltage between the $V_O(+)$ and $V_O(-)$ terminals must not exceed the minimum output overvoltage protection value shown in the Feature Specifications table. This limit includes any increase in voltage due to remote-sense compensation and output voltage set-point adjustment (trim). See Figure 21.

Although the output voltage can be increased by both the remote sense and by the trim, the maximum increase for the output voltage is not the sum of both. The maximum increase is the larger of either the remote sense or the trim. Consult the factory if you need to increase the output voltage more than the above limitation.

The amount of power delivered by the module is defined as the voltage at the output terminals multiplied by the output current. When using remote sense and trim, the output voltage of the module can be increased, which at the same output current would increase the power output of the module. Care should be taken to ensure that the maximum output power of the module remains at or below the maximum rated power.

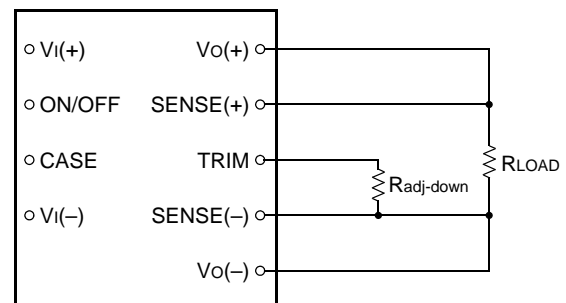

8-748(F).b

Figure 22. Circuit Configuration to Decrease Output Voltage

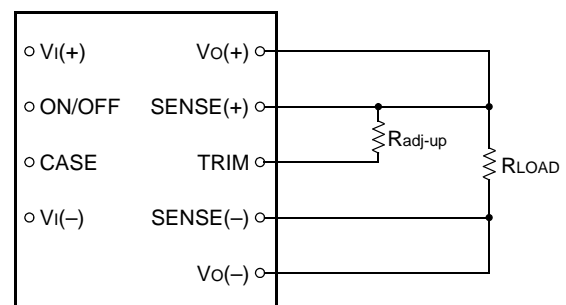

8-715(F).b

Figure 23. Circuit Configuration to Increase Output Voltage

Note: The output voltage of this module may be increased by a maximum of 0.5 V. The 0.5 V is the combination of both the remote-sense and the output voltage set-point adjustment (trim). Do not exceed 3.8 V between the $V_O(+)$ and $V_O(-)$ terminals.

Feature Descriptions (continued)

Output Overvoltage Protection

The output overvoltage protection consists of circuitry that monitors the voltage on the output terminals. If the voltage on the output terminals exceeds the overvoltage protection threshold, then the module will shut down and latch off. The overvoltage latch is reset by either cycling the input power for one second or by toggling the on/off signal for one second. If the auto-restart option is chosen, the unit will “hiccup” until the temperature is within specification.

Overtemperature Protection

These modules feature an overtemperature protection circuit to safeguard against thermal damage. The circuit shuts down and latches off the module when the maximum case temperature is exceeded. The module can be restarted by cycling the dc input power for at least one second or by toggling the remote on/off signal for at least one second. If the auto-restart option is chosen, the unit will “hiccup” until the temperature is within specification.

Thermal Considerations

Introduction

The power modules operate in a variety of thermal environments; however, sufficient cooling should be provided to help ensure reliable operation of the unit. Heat-dissipating components inside the unit are thermally coupled to the case. Heat is removed by conduction, convection, and radiation to the surrounding environment. Proper cooling can be verified by measuring the case temperature. Peak temperature (T_c) occurs at the position indicated in Figure 24.

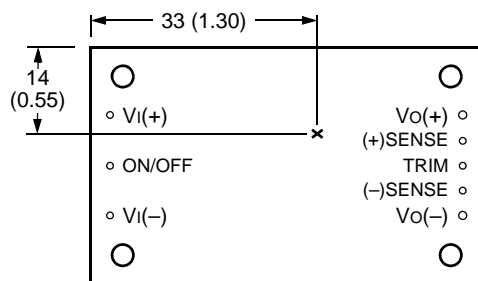

8-2104(F)

Note: Top view, pin locations are for reference only.
Measurements shown in millimeters and (inches).

Figure 24. Case Temperature Measurement Location

The temperature at this location should not exceed 100 °C. The output power of the module should not exceed the rated power for the module as listed in the Ordering Information table.

Although the maximum case temperature of the power modules is 100 °C, you can limit this temperature to a lower value for extremely high reliability.

Heat Transfer Without Heat Sinks

Increasing airflow over the module enhances the heat transfer via convection. Figures 25 and 26 show the maximum power that can be dissipated by the module without exceeding the maximum case temperature versus local ambient temperature (T_A) for natural convection through 3 m/s (600 ft./min.).

Note that the natural convection condition was measured at 0.05 m/s to 0.1 m/s (10 ft./min. to 20 ft./min.); however, systems in which these power modules may be used typically generate natural convection airflow rates of 0.3 m/s (60 ft./min.) due to other heat dissipating components in the system. The use of Figure 25 is shown in the following example.

Example

What is the minimum airflow necessary for a QHW100F1-Q operating at $V_I = 48$ V, an output current of 15 A, transverse orientation, and a maximum ambient temperature of 40 °C?

Solution

Given: $V_I = 48$ V
 $I_O = 15$ A
 $T_A = 40$ °C

Determine P_D (Use Figure 29):

$$P_D = 7.75 \text{ W}$$

Determine airflow (v) (Use Figure 25):

$$v = 0.5 \text{ m/s (100 ft./min.)}$$

Thermal Considerations (continued)

Heat Transfer Without Heat Sinks (continued)

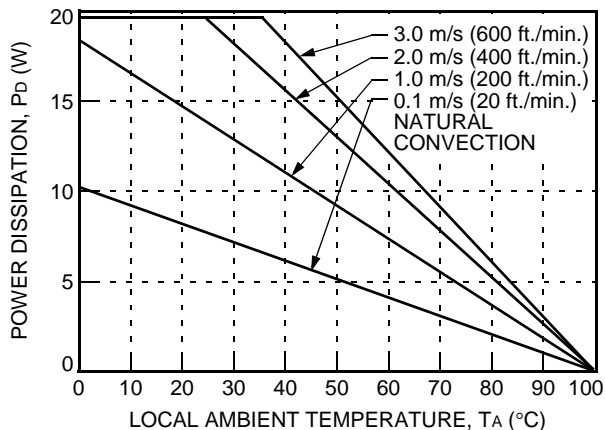

8-2321(F).a

Figure 25. Forced Convection Power Derating with No Heat Sink; Transverse Orientation

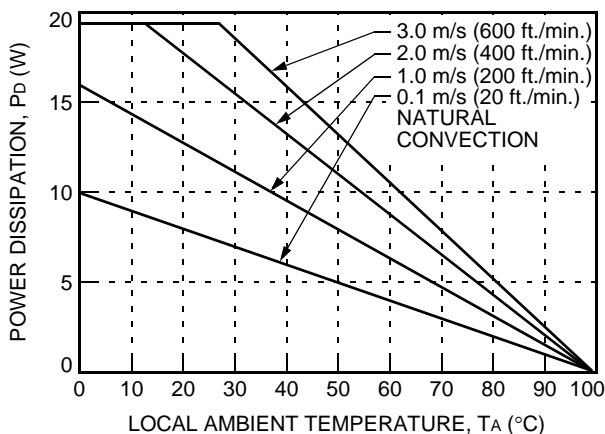

8-2318(F).b

Figure 26. Forced Convection Power Derating with No Heat Sink; Longitudinal Orientation

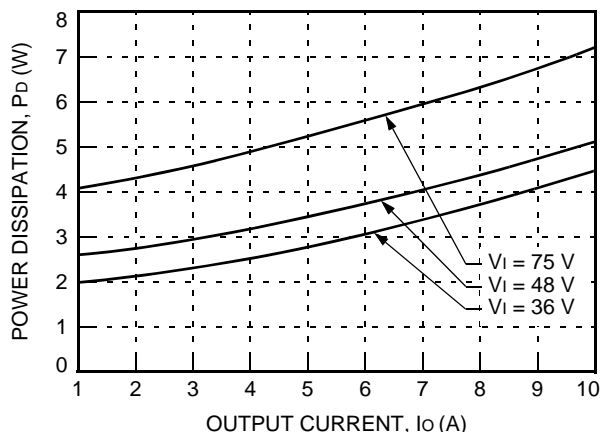

8-3270(F)

Figure 27. QHW050F1-Q Power Dissipation vs. Output Current at 25 °C

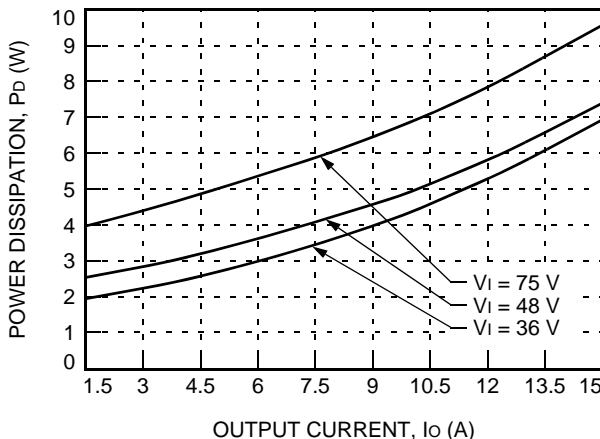

8-3459(F)

Figure 28. QHW075F1-Q Power Dissipation vs. Output Current at 25 °C

Thermal Considerations (continued)

Heat Transfer Without Heat Sinks (continued)

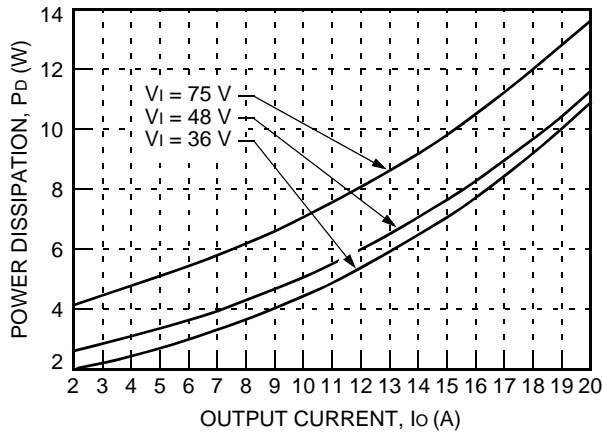

8-3271(F)

Figure 29. QHW100F1-Q Power Dissipation vs. Output Current at 25 °C

Heat Transfer with Heat Sinks

The power modules have through-threaded, M3 x 0.5 mounting holes, which enable heat sinks or cold plates to attach to the module. The mounting torque must not exceed 0.56 N-m (5 in.-lbs.). For a screw attachment from the pin side, the recommended hole size on the customer's PWB around the mounting holes is 0.130 ± 0.005 inches. If a larger hole is used, the mounting torque from the pin side must not exceed 0.25 N-m (2.2 in.-lbs.).

Thermal derating with heat sinks is expressed by using the overall thermal resistance of the module. Total module thermal resistance (θ_{ca}) is defined as the maximum case temperature rise ($\Delta T_{C, max}$) divided by the module power dissipation (P_D):

$$\theta_{ca} = \left[\frac{\Delta T_{C, max}}{P_D} \right] = \left[\frac{(T_C - T_A)}{P_D} \right]$$

The location to measure case temperature (T_C) is shown in Figure 24. Case-to-ambient thermal resistance vs. airflow is shown, for various heat sink configurations, heights, and orientations, as shown in Figures 30 and 31. Longitudinal orientation is defined as when the long axis of the module is parallel to the airflow direction, whereas in the transverse orientation, the long axis is perpendicular to the airflow. These curves were obtained by experimental testing of heat sinks, which are offered in the product catalog.

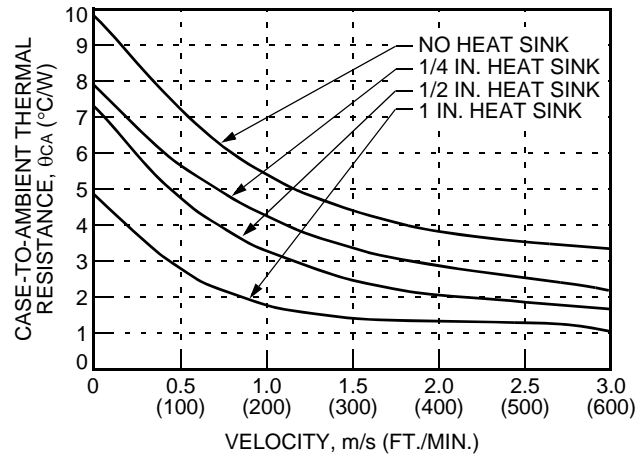

8-2323(F).a

Figure 30. Case-to-Ambient Thermal Resistance Curves; Transverse Orientation

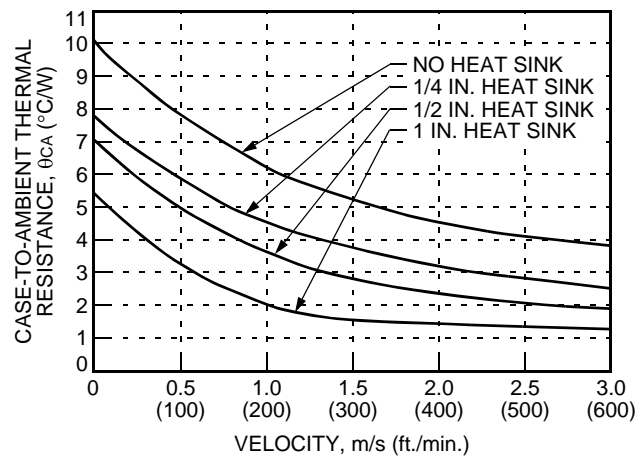

8-2324(F).a

Figure 31. Case-to-Ambient Thermal Resistance Curves; Longitudinal Orientation

Thermal Considerations (continued)

Heat Transfer with Heat Sinks (continued)

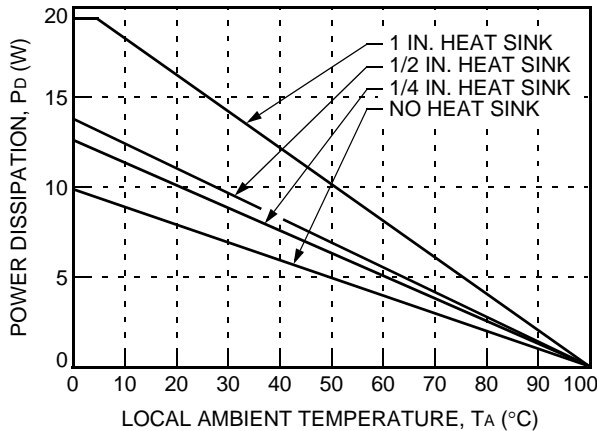

8-2889(F)

Figure 32. Heat Sink Power Derating Curves; Natural Convection; Transverse Orientation

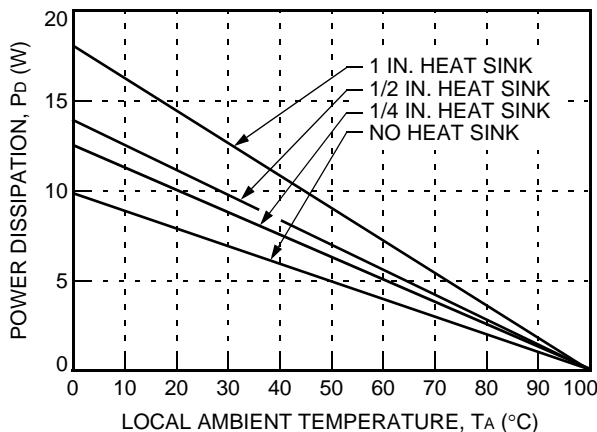

8-2890(F)

Figure 33. Heat Sink Power Derating Curves; Natural Convection; Longitudinal Orientation

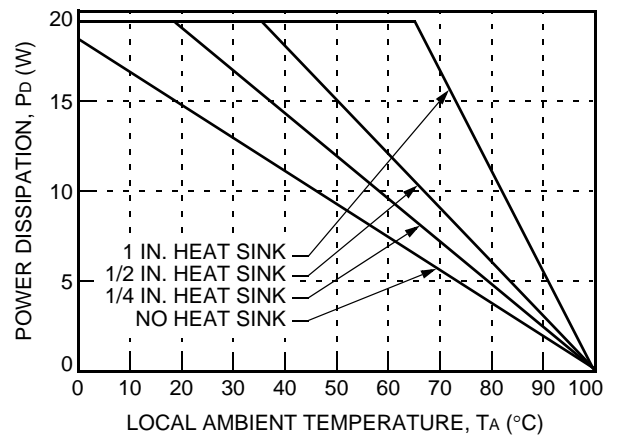

8-2891(F)

Figure 34. Heat Sink Power Derating Curves; 1.0 m/s (200 lfm); Transverse Orientation

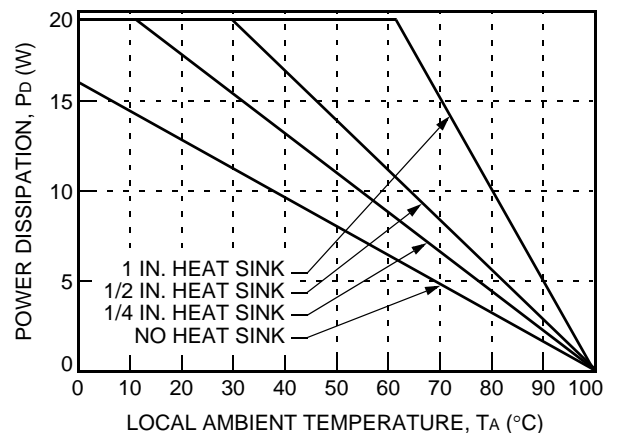

8-2892(F)

Figure 35. Heat Sink Power Derating Curves; 1.0 m/s (200 lfm); Longitudinal Orientation

These measured resistances are from heat transfer from the sides and bottom of the module as well as the top side with the attached heat sink; therefore, the case-to-ambient thermal resistances shown are generally lower than the resistance of the heat sink by itself. The module used to collect the data in Figures 30 and 31 had a thermal-conductive dry pad between the case and the heat sink to minimize contact resistance. The use of Figure 30 is shown in the following example.

Thermal Considerations (continued)

Heat Transfer with Heat Sinks (continued)

Example

If an 85 °C case temperature is desired, what is the minimum airflow necessary? Assume the QHW100F1-Q module is operating at $V_I = 48$ V and an output current of 20 A, maximum ambient air temperature of 40 °C, and the heat sink is 1/2 inch. The module is oriented in the transverse direction.

Solution

Given: $V_I = 48$ V
 $I_o = 20$ A
 $T_A = 40$ °C
 $T_C = 85$ °C
Heat sink = 1/2 inch

Determine P_D by using Figure 29:

$$P_D = 11.5 \text{ W}$$

Then solve the following equation:

$$\theta_{ca} = \left[\frac{(T_C - T_A)}{P_D} \right]$$

$$\theta_{ca} = \left[\frac{(85 - 40)}{11.5} \right]$$

$$\theta_{ca} = 3.91 \text{ °C/W}$$

Use Figure 30 to determine air velocity for the 1/2 inch heat sink.

The minimum airflow necessary for this module is 0.75 m/s (150 ft./min.).

Custom Heat Sinks

A more detailed model can be used to determine the required thermal resistance of a heat sink to provide necessary cooling. The total module resistance can be separated into a resistance from case-to-sink (θ_{cs}) and sink-to-ambient (θ_{sa}) as shown in Figure 36.

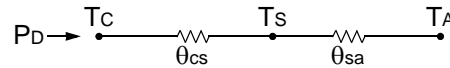

8-1304(F).e

Figure 36. Resistance from Case-to-Sink and Sink-to-Ambient

For a managed interface using thermal grease or foils, a value of $\theta_{cs} = 0.1$ °C/W to 0.3 °C/W is typical. The solution for heat sink resistance is:

$$\theta_{sa} = \left[\frac{(T_C - T_A)}{P_D} \right] - \theta_{cs}$$

This equation assumes that all dissipated power must be shed by the heat sink. Depending on the user-defined application environment, a more accurate model, including heat transfer from the sides and bottom of the module, can be used. This equation provides a conservative estimate for such instances.

EMC Considerations

For assistance with designing for EMC compliance, please refer to the *FLTR100V10 Filter Module Data Sheet* (DS99-294EPS).

Layout Considerations

Copper paths must not be routed beneath the power module mounting inserts. For additional layout guidelines, refer to the *FLTR100V10 Filter Module Data Sheet* (DS99-294EPS).

Outline Diagram

Dimensions are in millimeters and (inches).

Tolerances: x.x mm \pm 0.5 mm (x.xx in. \pm 0.02 in.)
x.xx mm \pm 0.25 mm (x.xxx in. \pm 0.010 in.)

Top View

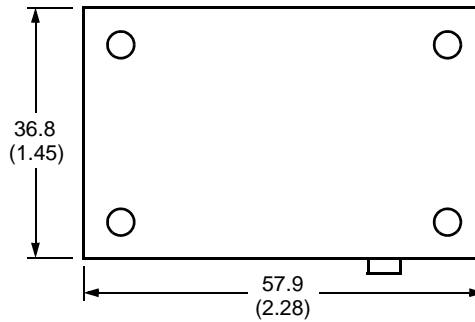

Side View

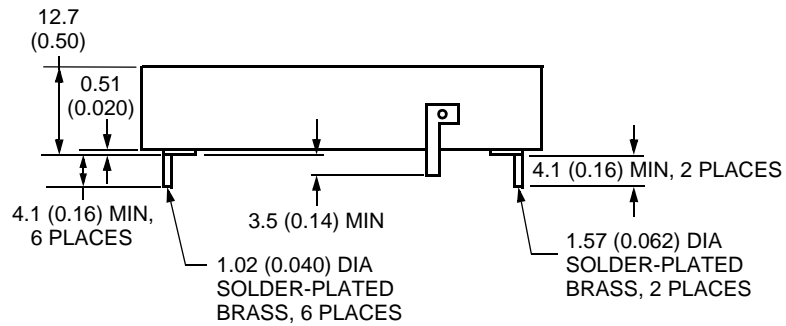

Bottom View

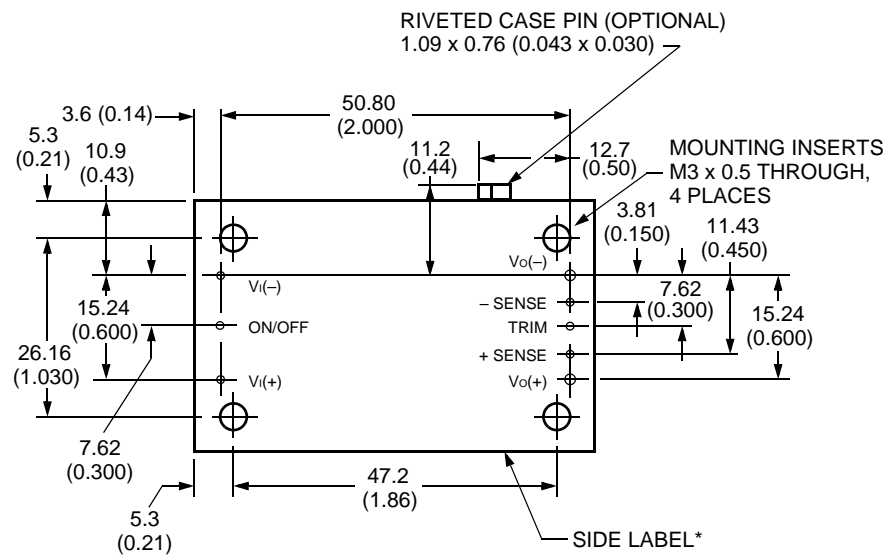

8-1769(F).b

* Side label includes Lineage name, product designation, safety agency markings, input/output voltage and current ratings, and bar code.

Recommended Hole Pattern

Component-side footprint.

Dimensions are in millimeters and (inches).

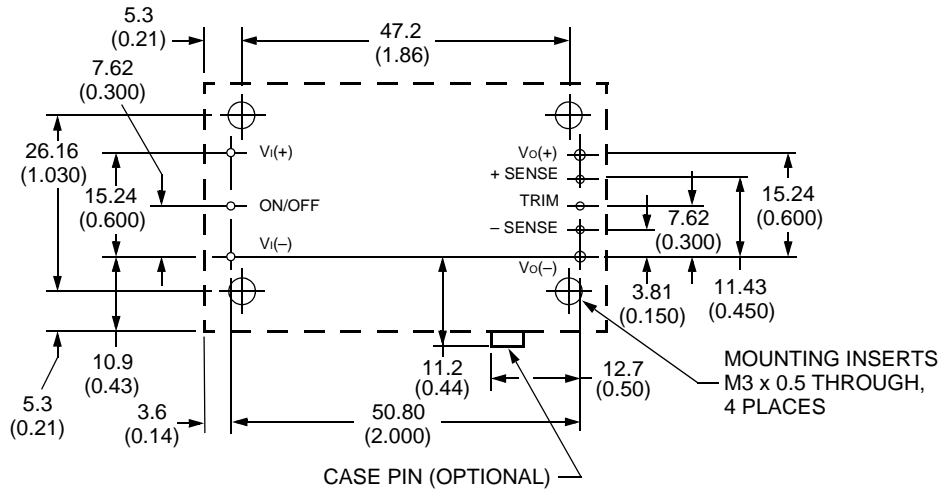

8-1769(F).b

Ordering Information

Please contact your Lineage Power Account Manager or Field Application Engineer for pricing and availability.

Table 4. Device Codes

Input Voltage	Output Voltage	Output Power	Output Current	Remote On/Off Logic	Device Code	Comcode
48 Vdc	3.3 Vdc	33 W	10 A	Negative	QHW050F1-Q	108741596
48 Vdc	3.3 Vdc	49.5 W	15 A	Negative	QHW075F1-Q	108741612
48 Vdc	3.3 Vdc	66 W	20 A	Negative	QHW100F1-Q	108741570

Optional features can be ordered using the suffixes shown in Table 5. To order more than one option, list device codes suffixes in numerically descending order. For example, the device code for a QHW100F1-Q module with the following option is shown below:

Auto-restart after overtemperature, overvoltage, or overcurrent shutdown QHW100F41-Q

Table 5. Device Options

Option	Device Code Suffix
Short pins: 2.79 mm ± 0.25 mm (0.110 in. +0.020 in./-0.010 in.)	8
Case ground pin	7
Short pins: 3.68 mm ± 0.25 mm (0.145 in. ± 0.010 in.)	6
Auto-restart after overtemperature, overvoltage, or overcurrent shutdown	4

Ordering Information (continued)

Table 6. Device Accessories

Accessory	Comcode
1/4 in. transverse kit (heat sink, thermal pad, and screws)	848060992
1/4 in. longitudinal kit (heat sink, thermal pad, and screws)	848061008
1/2 in. transverse kit (heat sink, thermal pad, and screws)	848061016
1/2 in. longitudinal kit (heat sink, thermal pad, and screws)	848061024
1 in. transverse kit (heat sink, thermal pad, and screws)	848061032
1 in. longitudinal kit (heat sink, thermal pad, and screws)	848061040

Dimensions are in millimeters and (inches).

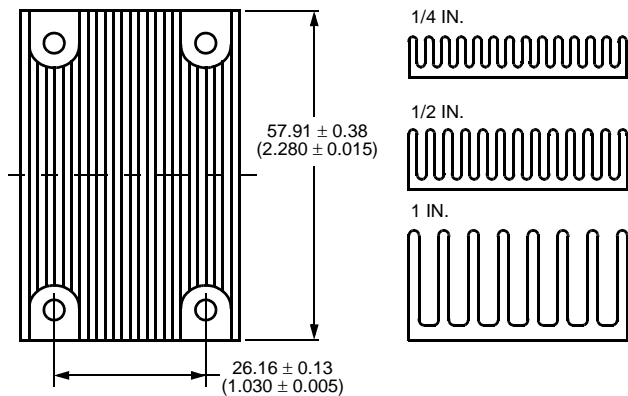

8-2473(F)

Figure 37. Longitudinal Heat Sink

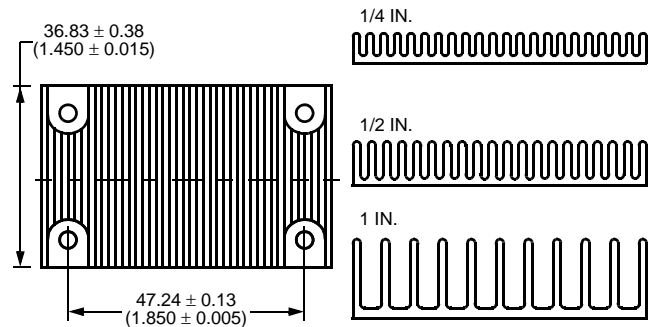

8-2472(F)

Figure 38. Transverse Heat Sink



World Wide Headquarters

Lineage Power Corporation

3000 Skyline Drive, Mesquite, TX 75149, USA

+1-800-526-7819

(Outside U.S.A.: **+1-972-284-2626**)

www.lineagepower.com

e-mail: techsupport1@lineagepower.com

Asia-Pacific Headquarters

Tel: +65 6 41 6 4283

Europe, Middle-East and Africa Headquarters

Tel: +49 89 6089 286

India Headquarters

Tel: +91 80 28411633

Lineage Power reserves the right to make changes to the product(s) or information contained herein without notice. No liability is assumed as a result of their use or application. No rights under any patent accompany the sale of any such product(s) or information.

© 2008 Lineage Power Corporation, (Mesquite, Texas) All International Rights Reserved.

April 2008

FDS01-087EPS (Replaces FDS01-086EPS)