

Features

- 2:1 Wide Input Voltage Range
- 30 Watts Output Power
- 1.6kVDC Isolation
- UL Pending
- Fixed Operating Frequency
- Six-Sided Continuous Shield
- Standard 50.8 x25.4x10.2mm Package
- Efficiency to 91%

POWERLINE

DC/DC-Converter

with 3 year Warranty



RECOM

Description

The RP30-F series DC/DC converters are designed to meet to UL 60950-1 and to cUL 60950-1. This makes them ideal for all telecom and industrial applications where approved safety standards are required. The industry standard 2" x 1" package meets military standards for thermal shock and vibration tolerance.

30 Watt 2" x 1" Package Single & Dual Output

Selection Guide 12V, 24V and 48V Input Types

Part Number	Input Range VDC	Output Voltage VDC	Output Current mA	Input Current ⁽⁴⁾ mA		Efficiency ⁽⁵⁾ %	Capacitive ⁽⁶⁾ Load max. μ F
				No Load	Full Load		
RP30-123.3SF	9-18	3.3	8000	90	2716	85	20000 μ F
RP30-1205SF	9-18	5	6000	130	3012	87	14400 μ F
RP30-1212SF	9-18	12	2500	90	2941	89	3000 μ F
RP30-1215SF	9-18	15	2000	80	2941	89	2000 μ F
RP30-243.3SF	18-36	3.3	8000	50	1325	87	20000 μ F
RP30-2405SF	18-36	5	6000	75	1453	90	14400 μ F
RP30-2412SF	18-36	12	2500	40	1437	91	3000 μ F
RP30-2415SF	18-36	15	2000	30	1437	91	2000 μ F
RP30-483.3SF	36-75	3.3	8000	30	663	87	20000 μ F
RP30-4805SF	36-75	5	6000	45	727	90	14400 μ F
RP30-4812SF	36-75	12	2500	40	718	91	3000 μ F
RP30-4815SF	36-75	15	2000	40	718	91	2000 μ F
RP30-1205DF	9-18	\pm 5	\pm 3000	90	3012	87	\pm 3000 μ F
RP30-1212DF	9-18	\pm 12	\pm 1250	50	3012	87	\pm 2000 μ F
RP30-1215DF	9-18	\pm 15	\pm 1000	40	3012	87	\pm 1300 μ F
RP30-2405DF	18-36	\pm 5	\pm 3000	70	1453	90	\pm 3000 μ F
RP30-2412DF	18-36	\pm 12	\pm 1250	30	1471	89	\pm 2000 μ F
RP30-2415DF	18-36	\pm 15	\pm 1000	30	1453	90	\pm 1300 μ F
RP30-4805DF	36-75	\pm 5	\pm 3000	35	727	90	\pm 3000 μ F
RP30-4812DF	36-75	\pm 12	\pm 1250	30	744	88	\pm 2000 μ F
RP30-4815DF	36-75	\pm 15	\pm 1000	20	735	89	\pm 1300 μ F

* no suffix for CTRL function with Positive Logic (1=ON, 0=OFF), this is standard

* add **/N** for CTRL function with Negative Logic (0=ON, 1=OFF)

* add suffix **-HC** for premounted heatsink and clips

Ordering Examples

RP30-2405SF = 24V Input, 5V Output, Positive Logic CTRL pin fitted

RP30-4812DF/N-HC = 48V Input, \pm 12V Output, Negative Logic CTRL pin fitted, Heatsink fitted



UL-60950-1 Certified
E196683

RP30-F

Please Read Application Notes

Derating Graph (Ambient Temperature)

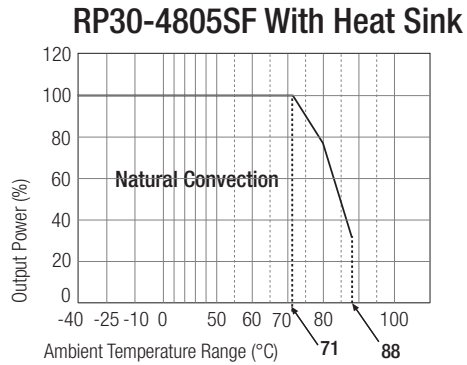
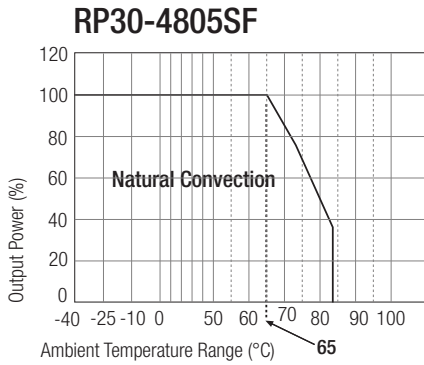

Derating graphs are valid only for the shown part numbers. If you need detailed derating-information about a part-number not shown here please contact our technical support service at info@recom-development.at

Typical Characteristics

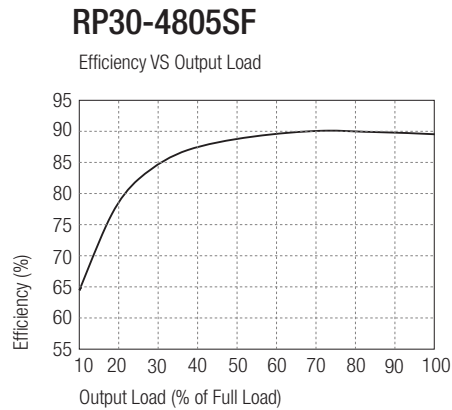
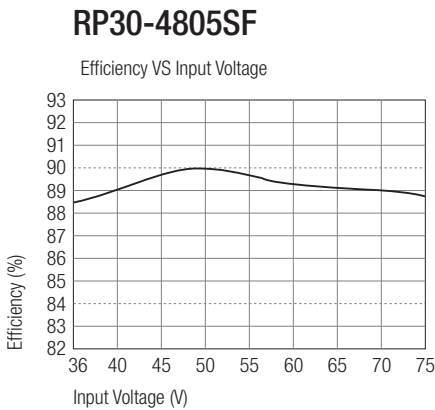

RP30-F

Specifications (typical at nominal input and 25°C unless otherwise noted)

Input Voltage Range	12V nominal input	9-18VDC
	24V nominal input	18-36VDC
	48V nominal input	36-75VDC
Input Filter		Pi Type
Input Surge Voltage (100 ms max.)	12V Input	25VDC
	24V Input	50VDC
	48V Input	100VDC
Input Reflected Ripple (nominal Vin and full load) (see Note 3)		20mAp-p
Start Up Time (nominal Vin and constant resistor load)	Power up	30ms typ.
	Remote ON/OFF	30ms typ.
Start-up voltage	12V Input	9VDC
	24V Input	18VDC
	48V Input	36VDC
Shutdown voltage	12V Input	8VDC
	24V Input	16VDC
	48V Input	32VDC

continued on next page

Specifications (typical at nominal input and 25°C unless otherwise noted)

Remote ON/OFF (Optional. See Note 7) (Positive logic)(Standard)	DC-DC ON	Open or 3V < Vr < 12V
	DC-DC OFF	Short or 0V < Vr < 1.2V
(Negative logic)(Option)	DC-DC ON	Short or 0V < Vr < 1.2V
	DC-DC OFF	Open or 3V < Vr < 12V
Input current of Remote control pin	Nominal input	-0.5mA ~ +0.5mA
Remote OFF state input current	Nominal input	3mA
Output Power		30W max.
Output Voltage Accuracy (full Load and nominal Vin)		±1%
Voltage Adjustability		±10%
Minimum Load		0%
Line Regulation (low line, high line at full load)		±0.2%
Load Regulation (No load to full load)	Single	±0.5%
	Dual	±1%
Cross Regulation (asymmetrical 25% <>100% load)	Dual	±5%
Ripple and Noise (20MHz bandwidth) (Measured with a 1uF/50V MLCC)	3.3, 5V	100mVp-p
	12, 15V	150mVp-p
Temperature Coefficient		±0.02%/°C max.
Transient Response (25% load step change)		250µs
Over Voltage Protection	3.3V	3.9V
Zener diode clamp (only single)	5V, ±5V	6.2V
	12V, ±12V	15V
	15V, ±15V	18V
Over Load Protection (% of full load at nominal Vin)		150% typ
Short Circuit Protection		Hiccup, automatic recovery
Efficiency		see „Selection Guide“ table
Isolation Voltage (rated for one minute)	Input to Output	1600VDC
	Input (Output) to case	1600VDC
Case grounding		Connect case to -Vin with decoupling Y Cap
Isolation Resistance		1GΩ min.
Isolation Capacitance		1500pF max.
Operating Frequency		430kHz typ.
Operating Temperature Range		-40°C to +50°C(without derating) -40°C to +85°C(with derating)
Maximum Case Temperature		+105°C
Storage Temperature Range		-55°C to +125°C
Over Temperature Protection		+115°C typ.
Thermal Impedance (see Note 8)	Natural convection	12°C/Watt
	Natural convection with Heat Sink	10°C/Watt
Thermal Shock		MIL-STD-810F
Vibration		MIL-STD-810F
Relative Humidity		5% to 95% RH
Case Material		Nickel plated copper
Base Material		FR4 PCB
Potting Material		Epoxy (UL94-V0)

continued on next page

RP30-F

Specifications (typical at nominal input and 25°C unless otherwise noted)

Conducted Emissions (see Note 10)	EN55022	Class A
Radiated Emissions	EN55022	Class B
ESD	EN61000-4-2	Air ±8KV Perf. Criteria A
	EN61000-4-2	Contact ±6KV Perf. Criteria A
Radiated Immunity	EN61000-4-3	10V/m Perf. Criteria A
Fast Transient (see Note 9)	EN61000-4-4	±2KV Perf. Criteria A
Surge (see Note 9)	EN61000-4-5	±1KV Perf. Criteria A
Conducted Immunity	EN61000-4-6	10 Vr.m.s Perf. Criteria A
Weight		30.5g
Packing Quantity	Refer to App Notes for tube dimensions	9 pcs per Tube
Dimensions		50.8 x 25.4 x 10.2mm
MTBF (see Note 2)	Belcore-TR-NWT-000332	3.173 x 10 ⁶ hours
	MIL-HDBK-217F	5.548 x 10 ⁶ hours

Notes :

- The RP30-S_DF series does not require any minimum load.
- BELLCORE TR-NWT-000332. Case I: 50% Stress, Temperature at 40°C (Ground fixed and controlled environment)
MIL-HDBK-217F Notice2 @ TA= 25°C, Full load (Ground, Begin, controlled environment)
- Simulated source impedance of 12µH. 12µH inductor in series with +Vin.
- Typical value at nominal input voltage and no load of standard type
Maximum value at nominal input voltage and full load of standard type.
- Typical value at nominal input voltage and full load.
- Test by minimum Vin and constant resistor load.
- The ON/OFF control function can be positive or negative logic. The pin voltage is referenced to negative input.
Positive logic ON/OFF is standard, no suffix (Ex. RP30-2405SF)
Negative logic ON/OFF is marked with suffix-N (Ex. R320-2405SF/N).
- Heat sink is optional and P/N: 7G-0020-C . Powerline DC/DC Converters can be ordered with pre-mounted heatsinks including antivibration fixing clips (add suffix -HC). See Application Notes for heatsink details.
- An external filter capacitor is required if the module has to meet EN61000-4-4,EN61000-4-5.
The filter capacitor RECOM suggest: 12Vin & 24Vin : Nippon chemi-con KY series, 330µF/50V, ESR 55mΩ.
48Vin : Nippon chemi-con KY series, 220µF/100V, ESR 48mΩ.
- Meets class A with external components shown below. See application notes for Class B common mode filter suggestion

RP30-F

Package Style and Pinning (mm)

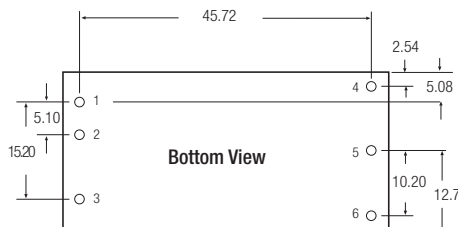
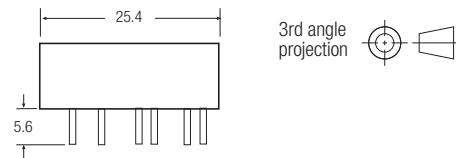
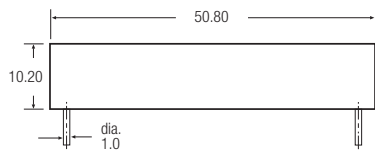

Pin Connections

Pin #	Single	Dual
1	+Vin	+Vin
2	-Vin	-Vin
3	CTRL	CTRL
4	+Vout	+Vout
5	-Vout	Com
6	Trim	-Vout

Pin Pitch Tolerance ±0.25 mm

EMC Filtering - For Class A filter suggestion, see Application Notes

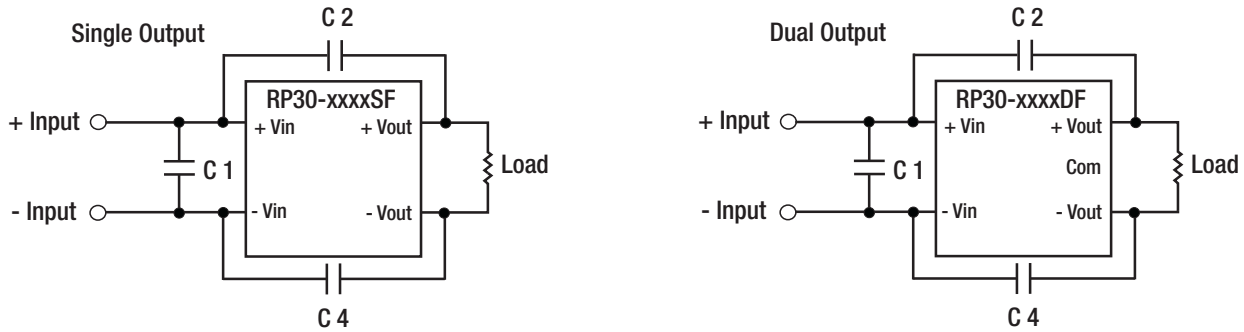

Single Output	C1	C2 & C3
RP30-12xxSF	10µF/25V 1812 MLCC	1000pF/2KV 1808 MLCC
RP30-24xxSF	6.8µF/50V 1812 MLCC	1000pF/2KV 1808 MLCC
RP30-48xxSF	2.2µF/100V 1812 MLCC	1000pF/2KV 1808 MLCC

Dual Output	C1	C2 & C4
RP30-12xxDF	10µF/25V 1812 MLCC	1000pF/2KV 1808 MLCC
RP30-24xxDF	6.8µF/50V 1812 MLCC	1000pF/2KV 1808 MLCC
RP30-48xxDF	2.2µF/100V 1812 MLCC	1000pF/2KV 1808 MLCC

Recommended EN55022 Class A Filter Circuit Layouts

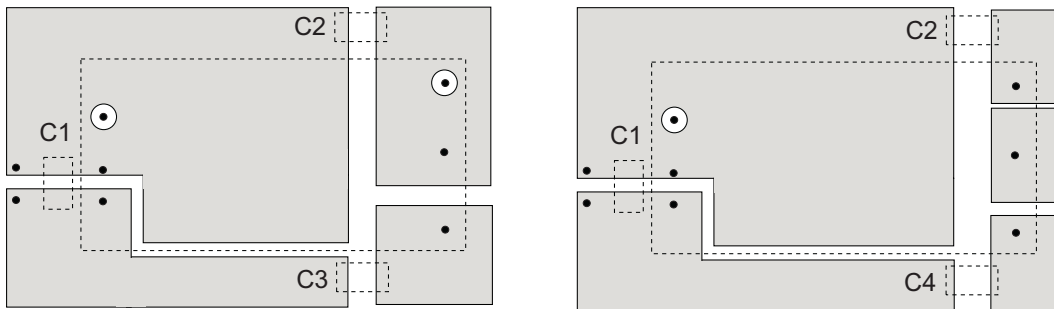

RP30-F

External Output Trimming

Output can be externally trimmed by using the method shown below. See Application Notes for details.

