

JC050C, JC075C, JC100C Power Modules: dc-dc Converters; 18 Vdc to 36 Vdc Input, 15 Vdc Output; 50 W to 100 W

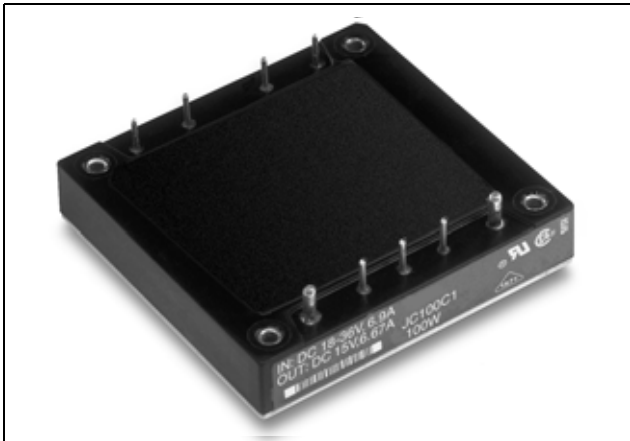

The JC050C, JC075C, JC100C Power Modules use advanced, surface-mount technology and deliver high-quality, efficient, compact dc-dc conversion.

Applications

- Distributed power architectures
- Workstations
- EDP equipment
- Telecommunications
- Wireless

Options

- Choice of remote on/off logic configuration
- Heat sink available for extended operation

Description

The JC050C, JC075C, JC100C Power Modules are dc-dc converters that operate over an input voltage range of 18 Vdc to 36 Vdc and provide a precisely regulated dc output. The outputs are fully isolated from the inputs, allowing versatile polarity configurations and grounding connections. The modules have maximum power ratings from 50 W to 100 W at typical full-load efficiency of 88%.

The sealed modules offer metal baseplate for excellent thermal performance. Threaded-through holes are provided to allow easy mounting or addition of a heat sink for high-temperature applications. The standard feature set includes remote sensing, output trim, and remote on/off for convenient flexibility in distributed power applications.

Features

- Small size: 61.0 mm x 57.9 mm x 12.7 mm (2.40 in. x 2.28 in. x 0.50 in.)
- High power density
- High efficiency: 88% typical
- Low output noise
- Constant frequency
- Industry-standard pinout
- Metal baseplate
- 2:1 input voltage range
- Overtemperature protection (100 W only)
- Remote sense
- Remote on/off
- Adjustable output voltage
- Case ground pin
- *UL** Recognized, *CSA*† Certified, VDE Licensed

* *UL* is a registered trademark of Underwriters Laboratories, Inc.
† *CSA* is a registered trademark of Canadian Standards Assn.

Absolute Maximum Ratings

Stresses in excess of the absolute maximum ratings can cause permanent damage to the device. These are absolute stress ratings only. Functional operation of the device is not implied at these or any other conditions in excess of those given in the operations sections of the data sheet. Exposure to absolute maximum ratings for extended periods can adversely affect device reliability.

Parameter	Symbol	Min	Max	Unit
Input Voltage Continuous	V_I	—	50	Vdc
I/O Isolation Voltage	—	—	1500	Vdc
Operating Case Temperature (See Thermal Considerations section.)	T_C	-40	100	°C
Storage Temperature	T_{stg}	-55	125	°C

Electrical Specifications

Unless otherwise indicated, specifications apply over all operating input voltage, resistive load, and temperature conditions.

Table 1. Input Specifications

Parameter	Symbol	Min	Typ	Max	Unit
Operating Input Voltage	V_I	18	28	36	Vdc
Maximum Input Current ($V_I = 0$ V to 36 V; $I_O = I_{O, max}$):					
JC050C (See Figure 1)	$I_{I, max}$	—	—	3.5	A
JC075C	$I_{I, max}$	—	—	5.2	A
JC100C (See Figure 2.)	$I_{I, max}$	—	—	6.9	A
Inrush Transient	i^2t	—	—	1.0	A ² s
Input Reflected-ripple Current, Peak-to-peak (5 Hz to 20 MHz, 12 μ H source impedance; see Figure 11.)	—	—	5	—	mAp-p
Input Ripple Rejection (120 Hz)	—	—	60	—	dB

Fusing Considerations

CAUTION: This power module is not internally fused. An input line fuse must always be used.

This encapsulated power module can be used in a wide variety of applications, ranging from simple stand-alone operation to an integrated part of a sophisticated power architecture. To preserve maximum flexibility, internal fusing is not included; however, to achieve maximum safety and system protection, always use an input line fuse. The safety agencies require a normal-blow, dc fuse with a maximum rating of 20 A (see Safety Considerations section). Based on the information provided in this data sheet on inrush energy and maximum dc input current, the same type of fuse with a lower rating can be used. Refer to the fuse manufacturer's data for further information.

Electrical Specifications (continued)

Table 2. Output Specifications

Parameter	Device	Symbol	Min	Typ	Max	Unit
Output Voltage (Over all operating input voltage, resistive load, and temperature conditions until end of life; see Figure 13.)	All	V_o	14.55	—	15.45	Vdc
Output Voltage Set Point ($V_i = 28$ V; $I_o = I_{o, max}$; $T_c = 25$ °C)	All	$V_{o, set}$	14.73	15.0	15.27	Vdc
Output Regulation: Line ($V_i = 18$ V to 36 V) Load ($I_o = I_{o, min}$ to $I_{o, max}$) Temperature ($T_c = -40$ °C to +100 °C)	All All All	— — —	— — —	0.01 0.05 50	0.2 0.4 150	% % mV
Output Ripple and Noise Voltage (See Figure 11.): RMS Peak-to-peak (5 Hz to 20 MHz)	All All	— —	— —	— —	60 250	mVrms mVp-p
External Load Capacitance (electrolytic)	All	—	0	—	10,000	μF
Output Current (At $I_o < I_{o, min}$, the module may exceed output ripple specifications.)	JC050C JC075C JC100C	I_o I_o I_o	0.3 0.3 0.3	— — —	3.33 5.0 6.7	A A A
Output Current-limit Inception ($V_o = 90\%$ of $V_{o, nom}$)	JC050C JC075C JC100C	$I_{o, cli}$ $I_{o, cli}$ $I_{o, cli}$	— — —	3.8 5.8 7.7	4.6 7.0 8.7	A A A
Output Short-circuit Current ($V_o = 250$ mV)	All	—	—	170	—	% $I_{o, max}$
Efficiency ($V_i = 28$ V; $I_o = I_{o, max}$; $T_c = 70$ °C; see Figure 13.)	JC050C JC075C JC100C	η η η	86 86 87	88 88 88	— — —	% % %
Dynamic Response ($\Delta I_o / \Delta t = 1$ A/10 μs, $V_i = 28$ V, $T_c = 25$ °C): Load Change from $I_o = 50\%$ to 75% of $I_{o, max}$: Peak Deviation Settling Time ($V_o < 10\%$ of peak deviation) Load Change from $I_o = 50\%$ to 25% of $I_{o, max}$: Peak Deviation Settling Time ($V_o < 10\%$ of peak deviation)	All All All All	— — — —	— — — —	2 300 2 300	— — — —	% $V_{o, set}$ μs % $V_{o, set}$ μs

Table 3. Isolation Specifications

Parameter	Min	Typ	Max	Unit
Isolation Capacitance	—	2500	—	pF
Isolation Resistance	10	—	—	MΩ

General Specifications

Parameter	Min	Typ	Max	Unit
Calculated MTBF ($I_o = 80\%$ of $I_{o, max}$; $T_c = 40\text{ }^\circ\text{C}$)		2,600,000		hr.
Weight	—	—	100 (3.5)	g (oz.)

Feature Specifications

Unless otherwise indicated, specifications apply over all operating input voltage, resistive load, and temperature conditions. See Feature Descriptions for additional information.

Parameter	Symbol	Min	Typ	Max	Unit
Remote On/Off Signal Interface ($V_I = 0\text{ V}$ to 36 V ; open collector or equivalent compatible; signal referenced to $V_I(-)$ terminal; see Figure 14 and Feature Descriptions.): JCxxxC1 Preferred Logic: Logic Low—Module On Logic High—Module Off JCxxxC Optional Logic Logic Low—Module Off Logic High—Module On Logic Low: At $I_{on/off} = 1.0\text{ mA}$ At $V_{on/off} = 0.0\text{ V}$ Logic High: At $I_{on/off} = 0.0\text{ }\mu\text{A}$ Leakage Current Turn-on Time (See Figure 10) ($I_o = 80\%$ of $I_{o, max}$; V_O within $\pm 1\%$ of steady state)	$V_{on/off}$ $I_{on/off}$ $V_{on/off}$ $I_{on/off}$ —	0 — — — —	— — — 20 —	1.2 1.0 15 50 35	V mA V μA ms
Output Voltage Adjustment (See Feature Descriptions.): Output Voltage Remote-sense Range Output Voltage Set-point Adjustment Range (trim) (Note: Ensure that the combination of remote-sense and trim do not exceed 15.5 V on the output.)	— —	— 50	— —	0.5 103	V % $V_{O, nom}$
Output Overvoltage Clamp	$V_{O, clamp}$	16.5	—	20.0	V
Overtemperature Shutdown (100 W only; see Feature Descriptions.)	T_c	—	105	—	$^\circ\text{C}$

Characteristic Curves

The following figures provide typical characteristics for the JC050C, JC075C, JC100C power modules. The figures are identical for both on/off configurations.

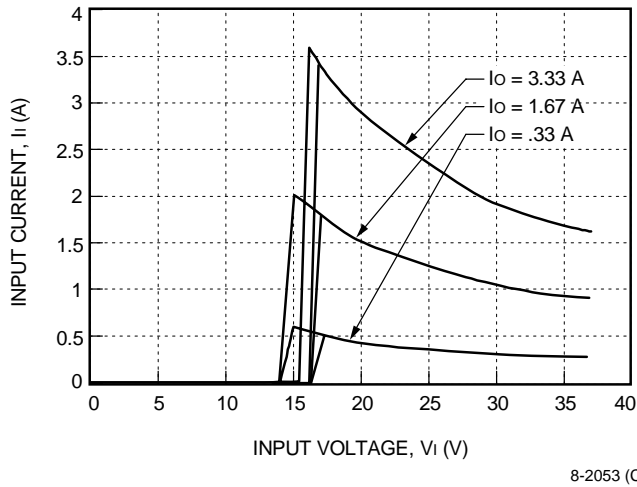

Figure 1. Typical JC050C Input Characteristics at Room Temperature

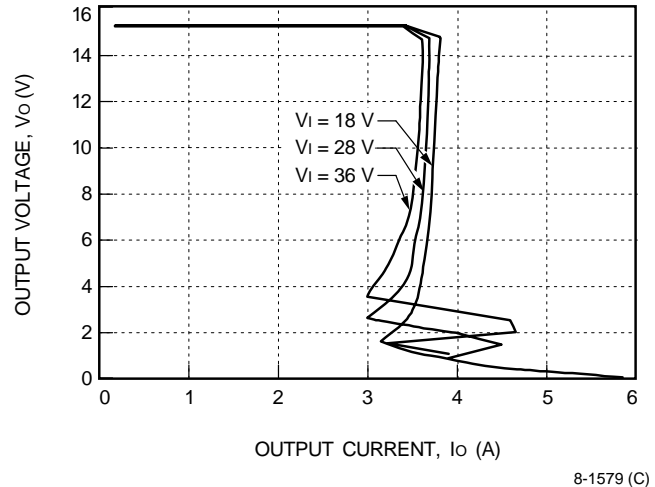

Figure 3. Typical JC050C Output Characteristics at Room Temperature

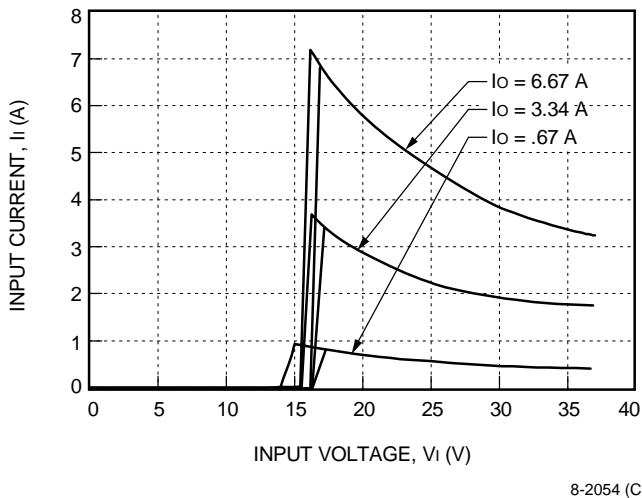

Figure 2. Typical JC100C Input Characteristics at Room Temperature

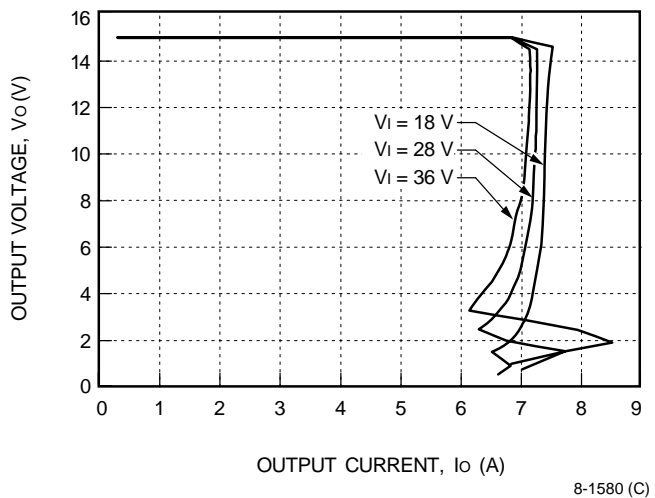

Figure 4. Typical JC100C Output Characteristics at Room Temperature

Characteristic Curves (continued)

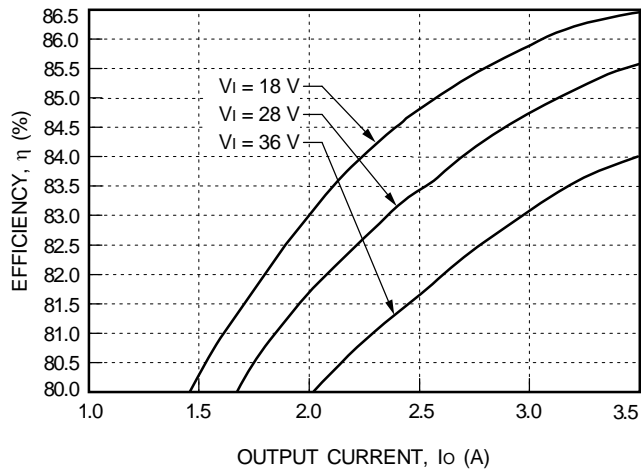

Figure 5. Typical JC050C Converter Efficiency vs. Output Current at Room Temperature

8-1581 (C)

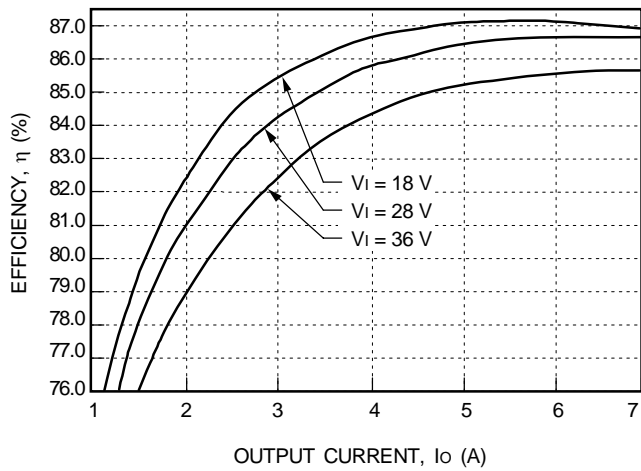
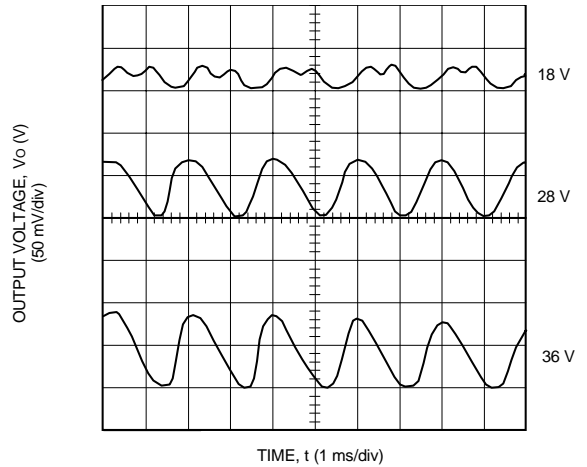

Figure 6. Typical JC100C Converter Efficiency vs. Output Current at Room Temperature

8-1582 (C)



8-1958 (C)

Figure 7. Typical JC100C Output Ripple Voltage at Room Temperature and 6.7 A Output

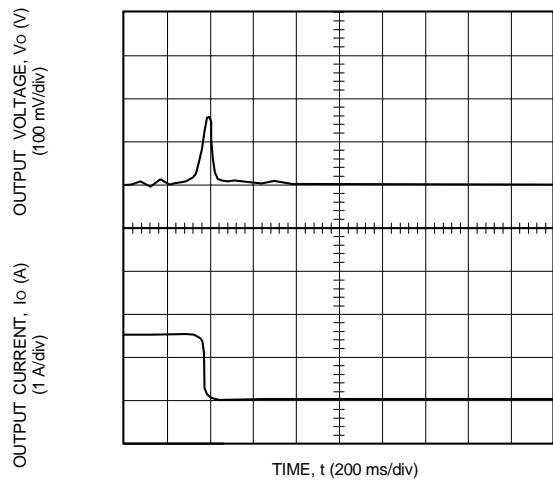

8-1956 (C)

Figure 8. Typical JC100C Transient Response to Step Decrease in Load from 50% to 25% of Full Load at Room Temperature and 28 V Input (Waveform Averaged to Eliminate Ripple Component.)

Characteristic Curves (continued)

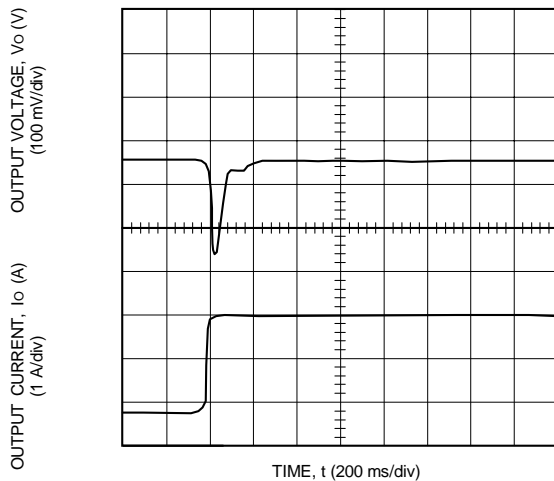

8-1957 (C)

Figure 9. Typical JC100C Transient Response to Step Increase in Load From 50% to 75% of Full Load at Room Temperature and 28 V Input (Waveform Averaged to Eliminate Ripple Component.)

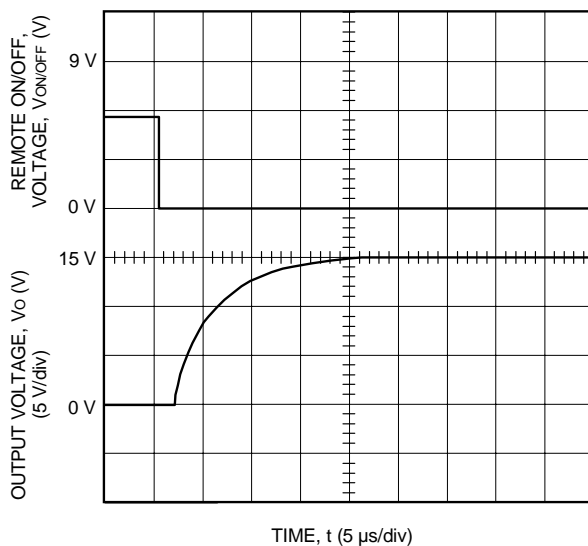

8-2055 (C)

Figure 10. Typical Start-Up from Remote On/Off JC100C1; Io = Full Load

Test Configurations

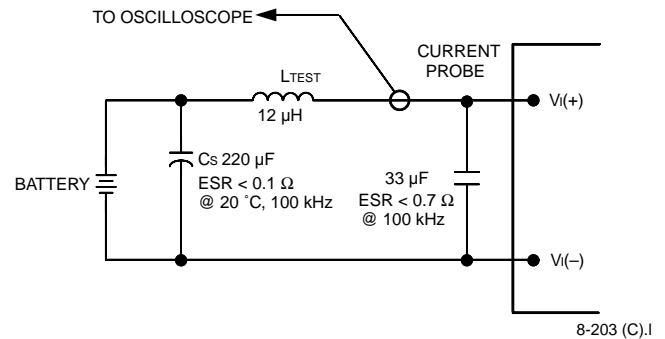

Note: Measure input reflected-ripple current with a simulated source inductance (LTEST) of 12 μH. Capacitor Cs offsets possible battery impedance. Measure current as shown above.

Figure 11. Input Reflected-Ripple Test Setup

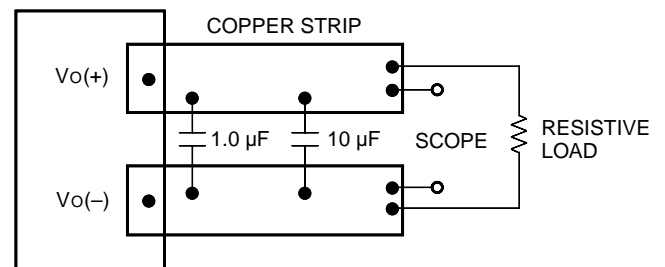

8-513 (C).d

Note: Use a 1.0 μF ceramic capacitor and a 10 μF aluminum or tantalum capacitor. Scope measurement should be made using a BNC socket. Position the load between 51 mm and 76 mm (2 in. and 3 in.) from the module.

Figure 12. Peak-to-Peak Output Noise Measurement Test Setup

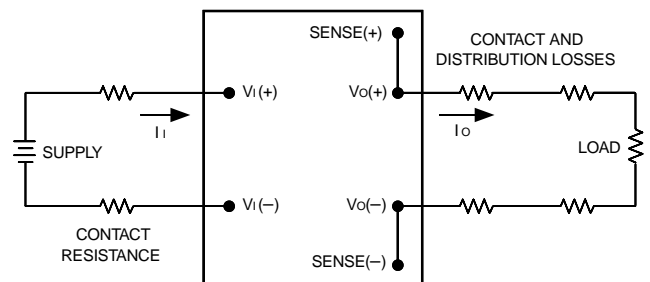

8-749 (C)

Note: All measurements are taken at the module terminals. When socketing, place Kelvin connections at module terminals to avoid measurement errors due to socket contact resistance.

$$\eta = \left(\frac{[V_{o(+)} - V_{o(-)}]I_o}{[V_{i(+)} - V_{i(-)}]I_i} \right) \times 100$$

Figure 13. Output Voltage and Efficiency Measurement Test Setup

Design Considerations

Input Source Impedance

The power module should be connected to a low ac-impedance input source. Highly inductive source impedances can affect the stability of the power module. For the test configuration in Figure 11, a 33 μF electrolytic capacitor (ESR < 0.7 Ω at 100 kHz) mounted close to the power module helps ensure stability of the unit. For other highly inductive source impedances, consult the factory for further application guidelines.

Safety Considerations

For safety-agency approval of the system in which the power module is used, the power module must be installed in compliance with the spacing and separation requirements of the end-use safety agency standard, i.e., UL-1950, CSA 22.2-950, and EN60950.

For the converter output to be considered meeting the requirements of safety extra-low voltage (SELV), the input must meet SELV requirements.

If the input meets extra-low voltage (ELV) requirements, then the converter's output is considered ELV.

The input to these units is to be provided with a maximum 20 A normal-blow fuse in the ungrounded lead.

Electrical Descriptions

Current Limit

To provide protection in a fault (output overload) condition, the unit is equipped with internal current-limiting circuitry and can endure current limiting for an unlimited duration. At the point of current-limit inception, the unit shifts from voltage control to current control. If the output voltage is pulled very low during a severe fault, the current-limit circuit can exhibit either foldback or tailout characteristics (output current decrease or increase). The unit operates normally once the output current is brought back into its specified range.

Feature Descriptions

Remote On/Off

Two remote on/off options are available. Positive logic remote on/off turns the module on during a logic-high voltage on the ON/OFF pin, and off during a logic low. Negative logic remote on/off turns the module off dur-

ing a logic high and on during a logic low. Negative logic (code suffix "1") is the factory-preferred configuration.

To turn the power module on and off, the user must supply a switch to control the voltage between the on/off terminal and the $V_{\text{I(-)}}$ terminal ($V_{\text{on/off}}$). The switch can be an open collector or equivalent (see Figure 14). A logic low is $V_{\text{on/off}} = 0 \text{ V}$ to 1.2 V. The maximum $I_{\text{on/off}}$ during a logic low is 1 mA. The switch should maintain a logic-low voltage while sinking 1 mA.

During a logic high, the maximum $V_{\text{on/off}}$ generated by the power module is 15 V. The maximum allowable leakage current of the switch at $V_{\text{on/off}} = 15 \text{ V}$ is 50 μA .

If not using the remote on/off feature, do one of the following:

- For negative logic, short ON/OFF pin to $V_{\text{I(-)}}$
- For positive logic, leave ON/OFF pin open.

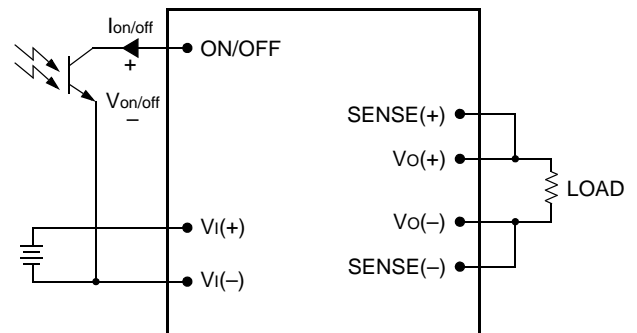

8-720 (C),c

Figure 14. Remote On/Off Implementation

Remote Sense

Remote sense minimizes the effects of distribution losses by regulating the voltage at the remote-sense connections. The voltage between the remote-sense pins and the output terminals must not exceed the output voltage sense range given in the Feature Specifications table, i.e.:

$$[V_{\text{O}(+)} - V_{\text{O}(-)}] - [\text{SENSE}(+) - \text{SENSE}(-)] \leq 1.2 \text{ V}$$

The voltage between the $V_{\text{O}(+)}$ and $V_{\text{O}(-)}$ terminals must not exceed 5.9 V. This limit includes any increase in voltage due to remote-sense compensation and output voltage set-point adjustment (trim), see Figure 15.

If not using the remote-sense feature to regulate the output at the point of load, then connect SENSE(+) to $V_{\text{O}(+)}$ and SENSE(-) to $V_{\text{O}(-)}$ at the module.

Feature descriptions (continued)

Remote Sense (continued)

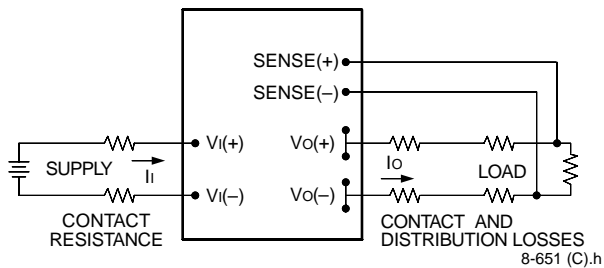

Figure 15. Effective Circuit Configuration for Single-Module Remote-Sense Operation

Output Voltage Set-Point Adjustment (Trim)

Output voltage trim allows the user to increase or decrease the output voltage set point of a module. This is accomplished by connecting an external resistor between the TRIM pin and either the SENSE(+) or SENSE(-) pins. With an external resistor between the TRIM and SENSE(-) pins ($R_{adj-down}$), the output voltage set point ($V_{o, adj}$) decreases (see Figure 16). The following equation determines the required external-resistor value to obtain a percentage output voltage change of $\Delta\%$.

$$R_{adj-down} = \left(\frac{100}{\Delta\%} - 2 \right) \text{ k}\Omega$$

The test results for this configuration are displayed in Figure 17. This figure applies to all output voltages.

With an external resistor connected between the TRIM and SENSE(+) pins (R_{adj-up}), the output voltage set point ($V_{o, adj}$) increases (see Figure 18).

Note: The output voltage of this module may be increased to a maximum of 0.5 V. The 0.5 V is the combination of both the remote-sense and the output voltage set-point adjustment (trim). Do not exceed 15.5 V between the VO(+) and VO(-) terminals.

The following equation determines the required external-resistor value to obtain a percentage output voltage change of $\Delta\%$.

$$R_{adj-up} = \left(\frac{V_o(100 + \Delta\%)}{1.225\Delta\%} - \frac{(100 + 2\Delta\%)}{\Delta\%} \right) \text{ k}\Omega$$

Only trim up to 0.5 V maximum. See note above.

The test results for this configuration are displayed in Figure 17. For applications requiring voltage between 15 V and 24 V, consider using the JC050H, JC075H, JC100H (24 V) trimmed down.

The voltage between the $V_o(+)$ and $V_o(-)$ terminals must not exceed 16.5 V. This limit includes any increase in voltage due to remote-sense compensation and output voltage set-point adjustment (trim). See Figure 15.

If not using the trim feature, leave the TRIM pin open.

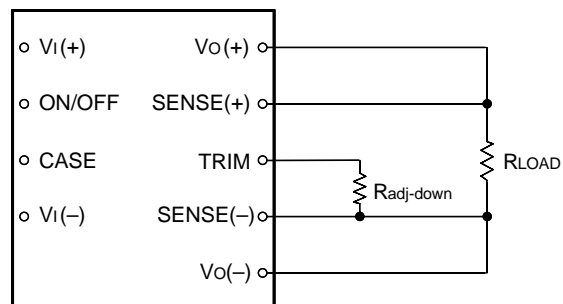

8-748 (C).c

Figure 16. Circuit Configuration to Decrease Output Voltage

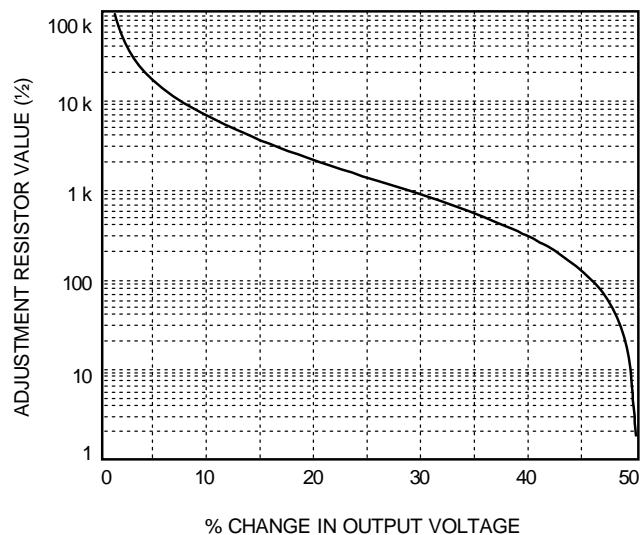

8-1237 (C).a

Figure 17. Resistor Selection for Decreased Output Voltage

Feature Descriptions(continued)

Output Voltage Set-Point Adjustment (Trim) (continued)

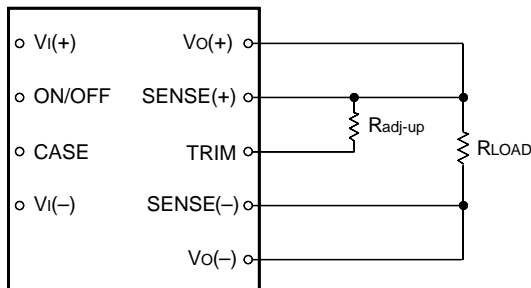

8-715 (C).d

Figure 18. Circuit Configuration to Increase Output Voltage

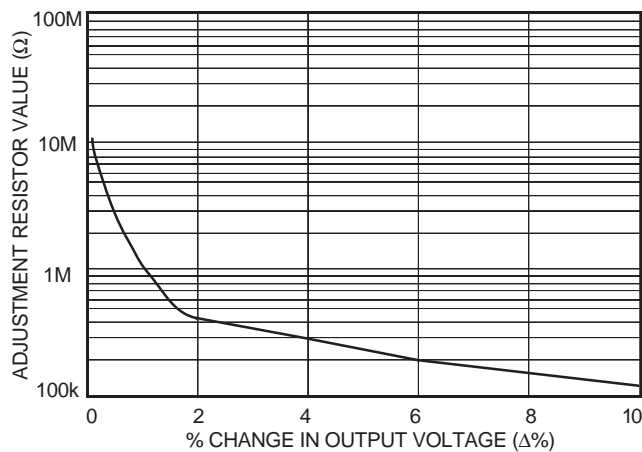

8-2056 (C)

Figure 19. Resistor Selection for Increased Output Voltage

Output Overvoltage Clamp

The output overvoltage clamp consists of control circuitry, independent of the primary regulation loop, that monitors the voltage on the output terminals. The control loop of the clamp has a higher voltage set point than the primary loop (see Feature specifications table). This provides a redundant voltage control that reduces the risk of output overvoltage.

Overtemperature Protection (Shutdown)

The 100 W module features an overtemperature protection circuit to safeguard against thermal damage. The circuit shuts down the module when the maximum case temperature is exceeded. The module restarts automatically after cooling.

Thermal Considerations

Introduction

The power modules operate in a variety of thermal environments; however, sufficient cooling should be provided to help ensure reliable operation of the unit. Heat-dissipating components inside the unit are thermally coupled to the case. Heat is removed by conduction, convection, and radiation to the surrounding environment. Proper cooling can be verified by measuring the case temperature. Peak temperature (T_c) occurs at the position indicated in Figure 20.

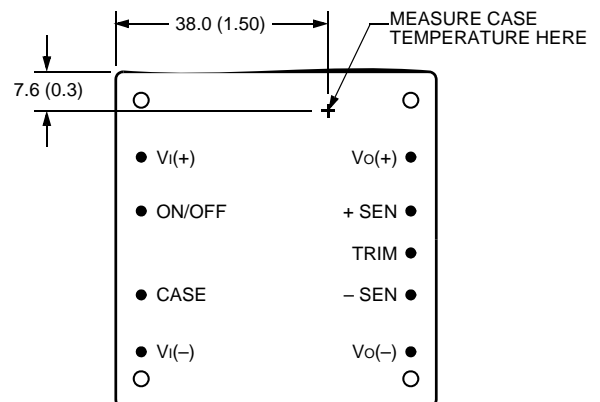

8-716 (C).f

Note: Top view, pin locations are for reference. Measurements shown in millimeters and (inches).

Figure 20. Case Temperature Measurement Location

The temperature at this location should not exceed 100 °C. The output power of the module should not exceed the rated power for the module as listed in the Ordering Information table.

Thermal Considerations (continued)

Introduction (continued)

Although the maximum case temperature of the power modules is 100 °C, you can limit this temperature to a lower value for extremely high reliability.

For additional information on these modules, refer to the *Thermal Management JC-, JFC-, JW-, and JFW-Series 50 W to 150 W Board-Mounted Power Modules Technical Note (TN97-008EPS)*.

Heat Transfer Without Heat Sinks

Increasing airflow over the module enhances the heat transfer via convection. Figure 21 shows the maximum power that can be dissipated by the module without exceeding the maximum case temperature versus local ambient temperature (T_A) for natural convection through 4 m/s (800 ft./min.).

Note that the natural convection condition was measured at 0.05 m/s to 0.1 m/s (10 ft./min. to 20 ft./min.); however, systems in which these power modules may be used typically generate natural convection airflow rates of 0.3 m/s (60 ft./min.) due to other heat dissipating components in the system. The use of Figure 21 is shown in the following example.

Example

What is the minimum airflow necessary for a JC100C operating at nominal line, an output current of 6 A, and a maximum ambient temperature of 40 °C?

Solution

Given: $V_I = 28\text{ V}$
 $I_O = 6\text{ A}$
 $T_A = 40\text{ °C}$

Determine P_D (Use Figure 23.):

$$P_D = 14.0\text{ W}$$

Determine airflow (v) (Use Figure 21.):

$$v = 1.5\text{ m/s (300 ft./min.)}$$

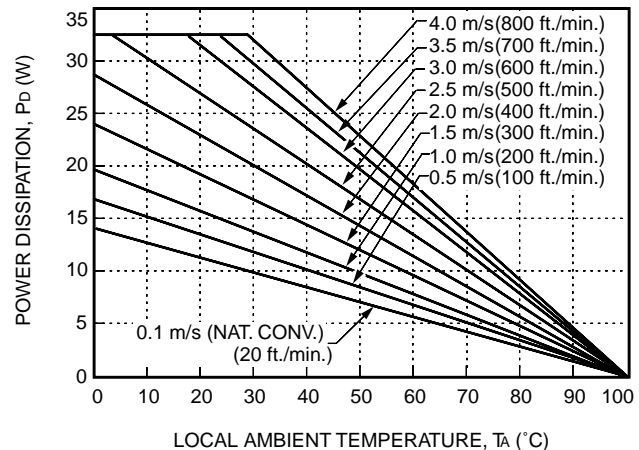

8-1150 (C).a

Figure 21. Forced Convection Power Derating with No Heat Sink; Either Orientation

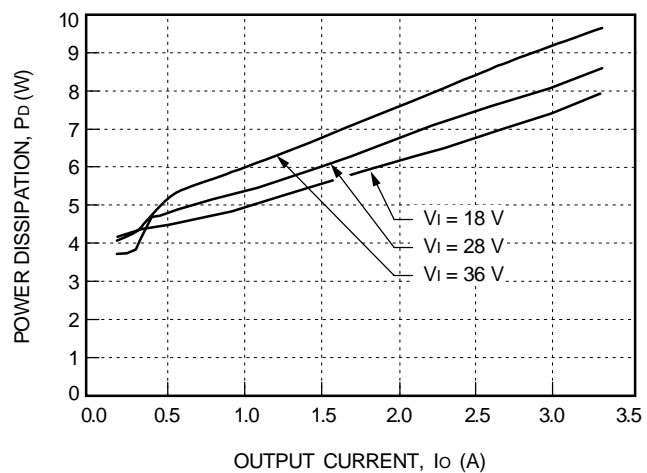

8-1583 (C)

Figure 22. JC050C Power Dissipation vs. Output Current

Thermal considerations (continued)

Heat Transfer Without Heat Sinks (continued)

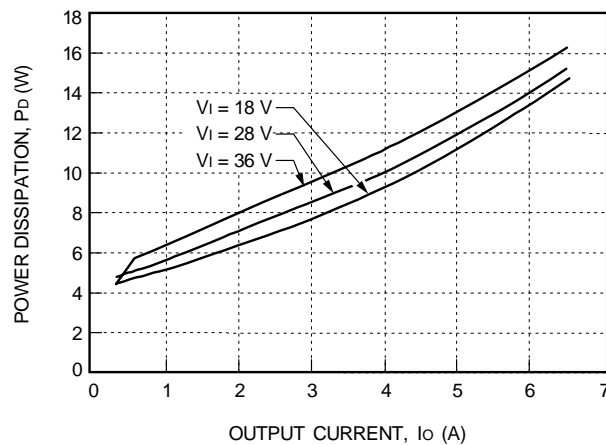

Figure 23. JC100C Power Dissipation vs. Output Current

8-1584 (C)

Heat Transfer with Heat Sinks

The power modules have through-threaded, M3 x 0.5 mounting holes, which enable heat sinks or cold plates to attach to the module. The mounting torque must not exceed 0.56 N-m (5 in.-lb.). For a screw attachment from the pin side, the recommended hole size on the customer's PWB around the mounting holes is 0.130 ± 0.005 inches. If a larger hole is used, the mounting torque from the pin side must not exceed 0.25 N-m (2.2 in.-lbs.).

Thermal derating with heat sinks is expressed by using the overall thermal resistance of the module. Total module thermal resistance (θ_{ca}) is defined as the maximum case temperature rise ($\Delta T_{C, max}$) divided by the module power dissipation (P_D):

$$\theta_{ca} = \left[\frac{\Delta T_{C, max}}{P_D} \right] = \left[\frac{(T_C - T_A)}{P_D} \right]$$

The location to measure case temperature (T_C) is shown in Figure 20. Case-to-ambient thermal resistance vs. airflow is shown, for various heat sink configurations and heights, in Figure 24. These curves were obtained by experimental testing of heat sinks, which are offered in the product catalog.

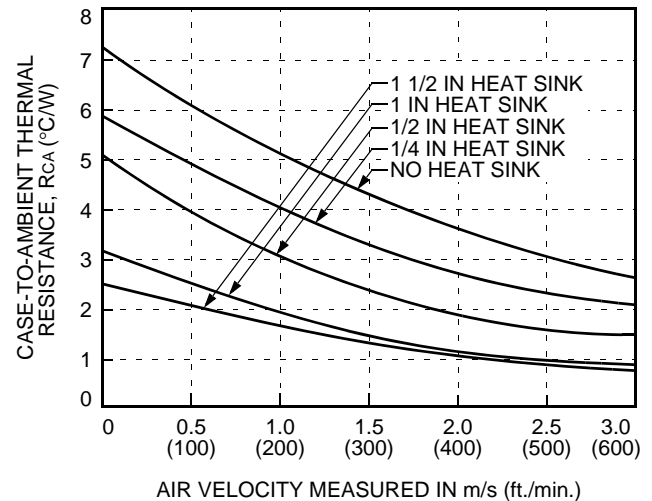

8-1153

Figure 24. Case-to-Ambient Thermal Resistance Curves; Either Orientation

These measured resistances are from heat transfer from the sides and bottom of the module as well as the top side with the attached heat sink; therefore, the case-to-ambient thermal resistances shown are generally lower than the resistance of the heat sink by itself. The module used to collect the data in Figure 24 had a thermal-conductive dry pad between the case and the heat sink to minimize contact resistance. The use of Figure 24 is shown in the following example

Example

If an 85 °C case temperature is desired, what is the minimum airflow necessary? Assume the JC100C module is operating at nominal line and an output current of 6 A, maximum ambient air temperature of 40 °C, and the heat sink is 0.5 in.

Thermal considerations (continued)

Heat Transfer with Heat Sinks (continued)

Solution

Given: $V_I = 28\text{ V}$
 $I_o = 6\text{ A}$
 $T_A = 40\text{ }^\circ\text{C}$
 $T_C = 85\text{ }^\circ\text{C}$
 Heat sink = 0.5 in.

Determine P_D by using Figure 23:

$$P_D = 14.0\text{ W}$$

Then solve the following equation:

$$\theta_{ca} = \left[\frac{(T_C - T_A)}{P_D} \right]$$

$$\theta_{ca} = \left[\frac{(85 - 40)}{14.0} \right]$$

$$\theta_{ca} = 3.2\text{ }^\circ\text{C/W}$$

Use Figure 24 to determine air velocity for the 0.5 inch heat sink.

The minimum airflow necessary for the JC100C module is 1.0 m/s (200 ft./min.).

Custom Heat Sinks

A more detailed model can be used to determine the required thermal resistance of a heat sink to provide necessary cooling. The total module resistance can be separated into a resistance from case-to-sink (θ_{cs}) and sink-to-ambient (θ_{sa}) shown below (Figure 25).



8-1304

Figure 25. Resistance from Case-to-Sink and Sink-to-Ambient

For a managed interface using thermal grease or foils, a value of $\theta_{cs} = 0.1\text{ }^\circ\text{C/W}$ to $0.3\text{ }^\circ\text{C/W}$ is typical. The solution for heat sink resistance is:

$$\theta_{sa} = \left[\frac{(T_C - T_A)}{P_D} \right] - \theta_{cs}$$

This equation assumes that all dissipated power must be shed by the heat sink. Depending on the user-defined application environment, a more accurate model, including heat transfer from the sides and bottom of the module, can be used. This equation provides a conservative estimate for such instances.

Layout Considerations

Copper paths must not be routed beneath the power module mounting inserts.

Outline Diagram

Dimensions are in millimeters and (inches).

Tolerances: x.x mm \pm 0.5 mm (x.xx in. \pm 0.02 in.)
 x.xx mm \pm 0.25 mm (x.xxx in. \pm 0.010 in.)

Top View

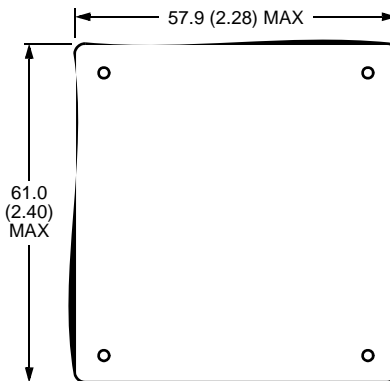

Side View

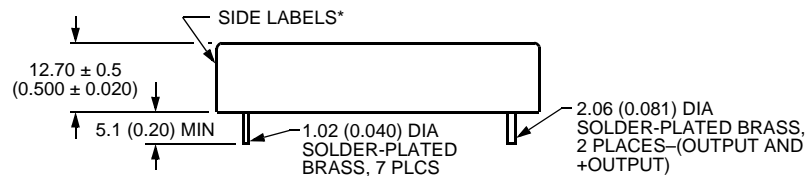

Bottom View

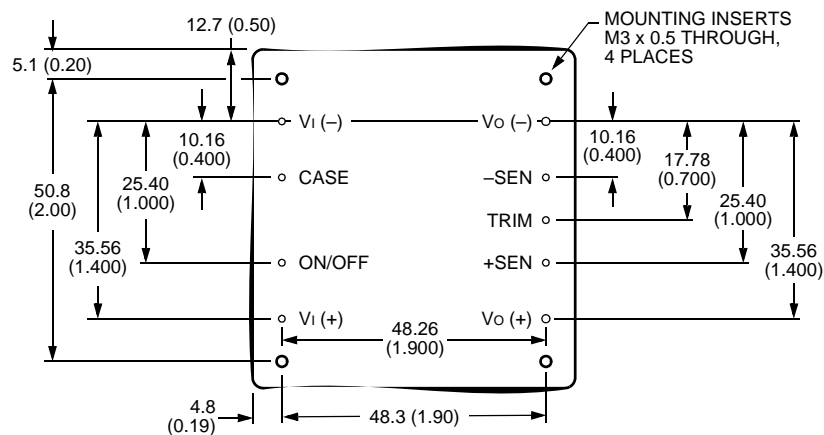

* Side labels include Lineage name, product designation, safety agency markings, input/output voltage and current ratings, and bar code.

Recommended Hole Pattern

Component-side footprint.

Dimensions are in millimeters and (inches).

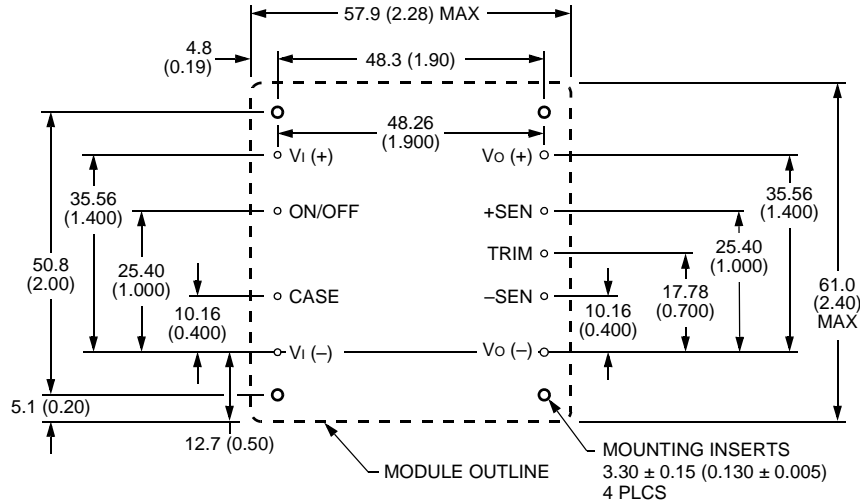

8-1945 (C).b

Ordering Information

Input Voltage	Output Voltage	Output Power	Remote On/Off Logic	Device Code	Comcode
28 V	15.0 V	50 W	negative	JC050C1	107314676
28 V	15.0 V	75 W	negative	JC075C1	TBD
28 V	15.0 V	100 W	negative	JC100C1	107314692
28 V	15.0 V	50 W	positive	JC050C	107309874
28 V	15.0 V	75 W	positive	JC075C	TBD
28 V	15.0 V	100 W	positive	JC100C	107309965



World Wide Headquarters

Lineage Power Corporation

3000 Skyline Drive, Mesquite, TX 75149, USA

+1-800-526-7819

(Outside U.S.A.: **+1-972-284-2626**)

www.lineagepower.com

e-mail: techsupport1@lineagepower.com

Asia-Pacific Headquarters

Tel: +65 641 6 4283

Europe, Middle-East and Africa Headquarters

Tel: +49 89 6089 286

India Headquarters

Tel: +91 80 28411633

Lineage Power reserves the right to make changes to the product(s) or information contained herein without notice. No liability is assumed as a result of their use or application. No rights under any patent accompany the sale of any such product(s) or information.

© 2008 Lineage Power Corporation, (Mesquite, Texas) All International Rights Reserved.