

HW050AF and HW050FG Power Modules: dc-dc Converters: 36 to 75 Vdc Input, 5.0 and 3.3 Vdc or 3.3 and 2.5 Vdc Dual Output; 50 W

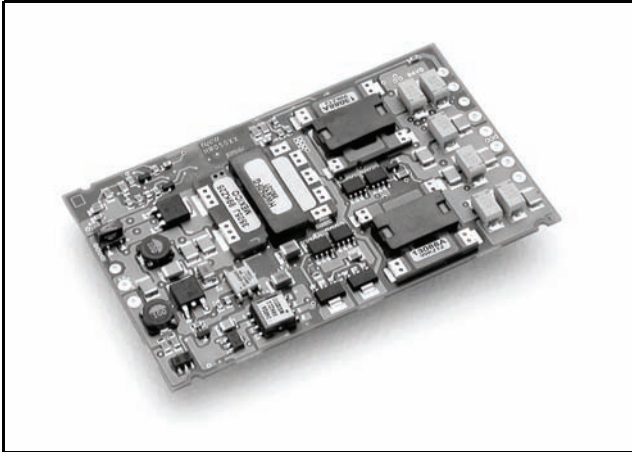

The HW050 Dual-Output Power Modules use advanced surface-mount technology and deliver high-quality, efficient, and compact dc-dc conversion.

Applications

- Distributed power architectures
- Communications equipment
- Computer equipment

Options

- Remote on/off logic choice (positive or negative)
- Short Pins

Description

The HW050 Dual-Output Power Modules are open frame (no case, no potting) dc-dc converters that operate over an input voltage range of 36 Vdc to 75 Vdc and provide two precisely regulated dc outputs. The module has a maximum power rating of 50 W, and uses synchronous rectification on both outputs to achieve a typical full-load efficiency of 85.5%.

Features

- Dual outputs with tight regulation
- Low profile
- Small size: 99.1 mm x 60.0 mm x 8.5 mm (3.90 in. x 2.36 in. x 0.33 in.)
- High efficiency: 85.5% typical
- Flexible loading between outputs
- Fixed frequency
- Open frame design; no case or potting
- Overcurrent protection
- Output overvoltage protection
- Remote on/off
- Wide output voltage adjustment
- Overtemperature protection
- Wide operating temperature range
- ISO* 9001 Certified manufacturing facilities
- Complies with ETSI ETI-300-321-2 voltage and current requirements .
- UL† 60950 Recognized, CSA‡ 22.2 No. 60950-00 Certified, and VDE§ 0805 (IEC60950) Licensed
- CE mark meets 73/23/EEC and 93/68/EEC directives**

* ISO is a registered trademark of the International Organization for Standardization.

† UL is a registered trademark of Underwriters Laboratories, Inc.

‡ CSA is a registered trademark of Canadian Standards Association.

§ VDE is a trademark of Verband Deutscher Elektrotechniker e.V.

** This product is intended for integration into end-use equipment. All the required procedures for CE marking of end-use equipment should be followed. (The CE mark is placed on selected products.)

Absolute Maximum Ratings

Stresses in excess of the absolute maximum ratings can cause permanent damage to the device. These are absolute stress ratings only. Functional operation of the device is not implied at these or any other conditions in excess of those given in the operations sections of the data sheet. Exposure to absolute maximum ratings for extended periods can adversely affect device reliability.

Parameter	Symbol	Min	Max	Unit
Input Voltage: Continuous	V_I	—	80	Vdc
Transient (2 ms)	$V_{I, trans}$	—	100	V
Operating Ambient Temperature (See Thermal Considerations section.)	T_A	-40	85*	°C
Storage Temperature	T_{stg}	-55	125	°C
I/O Isolation Voltage (for 1 minute)	—	—	1500	Vdc

* With derated output power, see Thermal Considerations section.

Electrical Specifications

Unless otherwise indicated, specifications apply over all operating input voltage, resistive load, and temperature conditions.

Table 1. Input Specifications

Parameter	Symbol	Min	Typ	Max	Unit
Operating Input Voltage	V_I	36	48	75	Vdc
Maximum Input Current	$I_{I, max}$	—	—	2.6	A
Inrush Transient	—	—	—	1.0	A ² s
Input Reflected-ripple Current, Peak-to-peak (5 Hz to 20 MHz, 12 μ H source impedance)	—	—	10	—	mAp-p
Input Ripple Rejection (100 Hz—120 Hz)	—	—	60	—	dB
EMC, EN55022 (V_I, nom , full load)	See EMC Consideration section.				

Fusing Considerations

CAUTION: This power module is not internally fused. An input line fuse must always be used.

This power module can be used in a wide variety of applications, ranging from simple stand-alone operation to an integrated part of a sophisticated power architecture. To preserve maximum flexibility, internal fusing is not included; however, to achieve maximum safety and system protection, always use an input line fuse. The safety agencies require a normal-blow, fuse with a maximum rating of 6 A (see Safety Considerations section). Based on the information provided in this data sheet on inrush energy and maximum dc input current, the same type of fuse with a lower rating can be used. Refer to the fuse manufacturer's data for further information.

Electrical Specifications (continued)

Table 2. Output Specifications

Parameter	Device	Symbol	Min	Typ	Max	Unit
Output Voltage Set Point ($V_I = 48\text{ V}$; $I_O = I_{O, \text{max}}$; $T_A = 25\text{ }^\circ\text{C}$)	HW050AF	$V_{O1, \text{set}}$	4.92	5.00	5.08	Vdc
		$V_{O2, \text{set}}$	3.25	3.30	3.35	Vdc
	HW050FG	$V_{O1, \text{set}}$	3.25	3.30	3.35	Vdc
		$V_{O2, \text{set}}$	2.46	2.50	2.54	Vdc
Output Voltage (Over all operating input voltage, resistive load, and temperature conditions until end of life. See Figure 21.)	HW050AF	V_{O1}	4.78	—	5.21	Vdc
		V_{O2}	3.16	—	3.44	Vdc
	HW050FG	V_{O1}	3.16	—	3.44	Vdc
		V_{O2}	2.42	—	2.58	Vdc
Output Regulation: Line ($V_I = 36\text{ V}$ to 75 V) Load ($I_O = I_{O, \text{min}}$ to $I_{O, \text{max}}$) Temperature ($T_A = -40\text{ }^\circ\text{C}$ to $+70\text{ }^\circ\text{C}$)	All	—	—	0.05	0.2	% V_O
	All	—	—	0.03	0.2	% V_O
	All	—	—	0.3	1.0	% V_O
Output Ripple and Noise Voltage (see Figure 20): RMS (5 Hz to 20 MHz bandwidth) ($V_I = 48\text{ V}$) Peak-to-peak (5 Hz to 20 MHz bandwidth) Temperature ($T_A = -25\text{ }^\circ\text{C}$ to $+70\text{ }^\circ\text{C}$)	HW050AF	—	—	—	45	mVrms
	HW050FG	—	—	—	45	mVrms
	HW050AF	—	—	—	150	mVp-p
	HW050FG	—	—	—	150	mVp-p
External Load Capacitance	All	—	0	—	10,000	μF
Output Current (At $I_O < I_{O, \text{min}}$, the modules may exceed output ripple specifications.) Note: The maximum combined output current must not exceed 12 A for HW050AF, 16 A for HW050FG.	HW050AF	I_{O1}	0.5	—	8.0	Adc
		I_{O2}	0.5	—	8.0	Adc
	HW050FG	I_{O1}	0.5	—	12.0	Adc
		I_{O2}	0.5	—	12.0	Adc
Output Current-limit Inception ($V_O = 90\%$ of $V_{O, \text{nom}}$; 4 A load on other output for HW050AF, and 4 A load on other output for HW050FG)	HW050AF	$I_{O, \text{cli}}$	—	11.0	13.0*	A
	HW050FG	$I_{O, \text{cli}}$	—	15.0	18.0*	A
Output Short-circuit Current ($V_O = 250\text{ mV}$)	All	—	—	30	—	% $I_{O, \text{max}}$
Efficiency (for $V_I = 48\text{ V}$, $T_A = 25\text{ }^\circ\text{C}$, for HW050AF $I_{O1} = 6\text{ A}$, $I_{O2} = 6\text{ A}$; for HW050FG $I_{O1} = 8\text{ A}$, $I_{O2} = 8\text{ A}$) When Trimmed to Lowest Voltages: HW050FG Trimmed to $V_{O1} = 2.5\text{ V}$, $V_{O2} = 1.5\text{ V}$, $I_{O1} = I_{O2} = 8\text{ A}$	HW050AF	η	—	85.5	—	%
	HW050FG	η	—	84.0	—	%
	HW050FG (trimmed down)	η	—	81.5	—	%
Switching Frequency	All	—	—	200	—	kHz

* These are manufacturing test limits. In some situations, results may differ.

Electrical Specifications (continued)

Table 2. Output Specifications (continued)

Parameter	Device	Symbol	Min	Typ	Max	Unit
Dynamic Response ($\Delta I_o/\Delta t = 1 \text{ A}/10 \text{ } \mu\text{s}$, $V_I = 48 \text{ V}$, $T_A = 25 \text{ }^\circ\text{C}$; tested without any load capacitance. Adding load capacitance will improve performance.):						
Load Change from $I_{O1} = 50\%$ to 75% of $I_{O1, \text{max}}$, $I_{O2} = 30\%$ of $I_{O2, \text{max}}$:						
Peak Deviation	All	—	—	200	—	mV
Settling Time ($V_o < 10\%$ of peak deviation)	All	—	—	200	—	μs
Load Change from $I_o = 50\%$ to 25% of $I_{O1, \text{max}}$, $I_{O2} = 30\%$ of $I_{O2, \text{max}}$:						
Peak Deviation	All	—	—	200	—	mV
Settling Time ($V_o < 10\%$ of peak deviation)	All	—	—	200	—	μs

Isolation Specifications

Parameter	Min	Typ	Max	Unit
Isolation Capacitance	—	40	—	nF
Isolation Resistance	10	—	—	$M\Omega$

General Specifications

Parameter	Min	Typ	Max	Unit
Calculated MTBF ($I_o = 80\%$ of $I_{o, \text{max}}$; $T_A = 20 \text{ }^\circ\text{C}$)		2,000,000		hours
Weight	—	—	60 (2.1)	g (oz.)

Feature Specifications

Unless otherwise indicated, specifications apply over all operating input voltage, resistive load, and temperature conditions. See Feature Descriptions for additional information.

Parameter	Device	Symbol	Min	Typ	Max	Unit
Remote On/Off Signal Interface ($V_I = 0\text{ V}$ to 75 V ; open collector or equivalent compatible; signal referenced to $V_I(-)$ terminal; see Figure 22 and Feature Descriptions.): HW050AF1 Preferred Logic: Logic Low—Module On Logic High—Module Off HW050FG Optional Logic: Logic Low—Module Off Logic High—Module On Logic Low: At $I_{on/off} = 1.0\text{ mA}$ At $V_{on/off} = 0.0\text{ V}$ Logic High: At $I_{on/off} = 0.0\text{ }\mu\text{A}$ Leakage Current Turn-on Time ($I_O = 80\%$ of $I_{O, max}$; V_O within $\pm 1\%$ of steady state; see Figure 17.)	— — — — All	$V_{on/off}$ $I_{on/off}$ $V_{on/off}$ $I_{on/off}$ —	0 — — — —	— — — — 30	1.2 1.0 15 50 45	V mA V μA ms
Output Voltage Set-point Adjustment (trim), Each Output: Note: There are trim restrictions based on output voltage combinations. Refer to the Feature Description section for details.	HW050AF HW050FG	for V_{O1} for V_{O2} for V_{O1} for V_{O2}	4.75 1.50 2.50 1.50	— — — —	5.25 3.46 3.46 2.50	V V V V
Output Overvoltage Protection (shutdown)	HW050AF HW050FG	V_{O1} & V_{O2} V_{O1} & V_{O2}	— —	— —	7.0* 4.6*	V V

* These are manufacturing test limits. In some situations, results may differ.

Solder Ball and Cleanliness Requirements

The open frame (no case or potting) power module will meet the solder ball requirements per J-STD-001B. These requirements state that solder balls must neither be loose nor violate the power module minimum electrical spacing.

The cleanliness designator of the open frame power module is C00 (per J specification).

Solder, Cleaning, and Drying Considerations

Post solder cleaning is usually the final circuit-board assembly process prior to electrical board testing. The result of inadequate circuit-board cleaning and drying can affect both the reliability of a power module and the testability of the finished circuit-board assembly. For guidance on appropriate soldering, cleaning, and drying procedures, refer to the *Board-Mounted Power Modules Soldering and Cleaning Application Note* (AP97-021EPS.)

Characteristic Curves

The following figures provide typical characteristics for the power modules. The figures are identical for both on/off configurations.

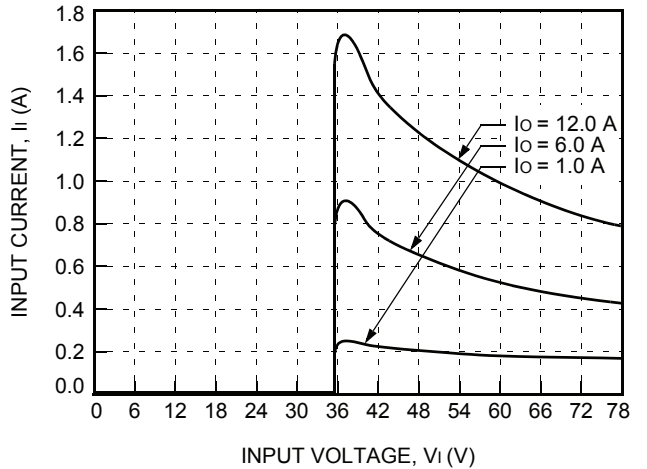

8-2669 (F)

Figure 1. Typical HW050AF1 Input Characteristics at Room Temperature

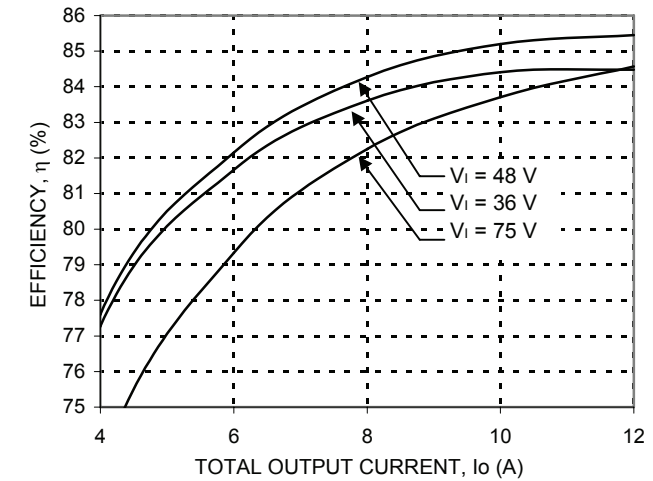
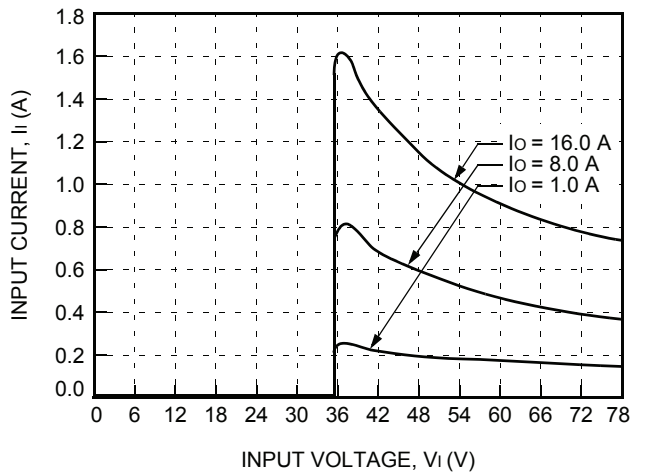

Figure 3. Typical HW050AF1 Converter Efficiency vs. Output Current at Room Temperature



8-2670 (F)

Figure 2. Typical HW050FG1 Input Characteristics at Room Temperature

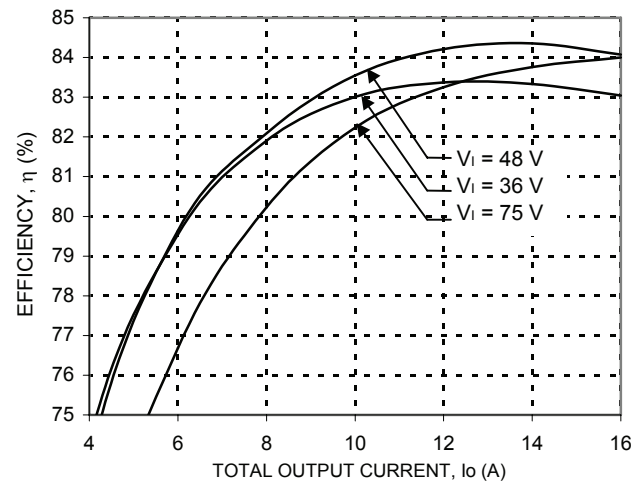
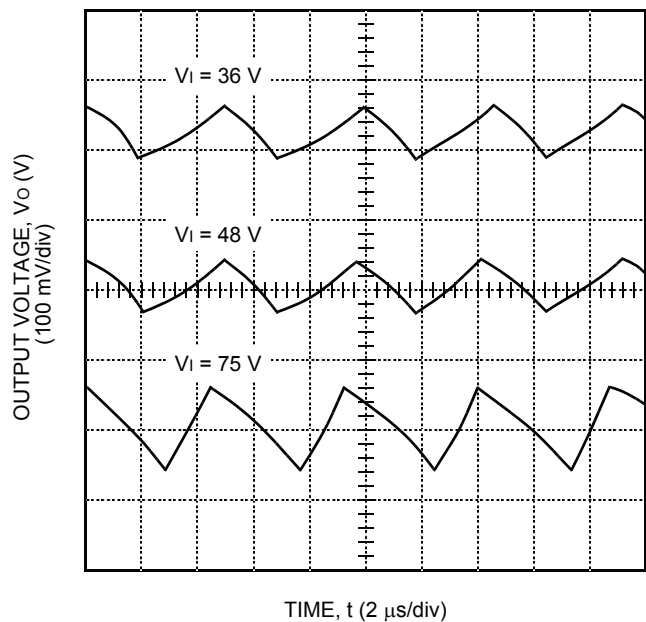

Figure 4. Typical HW050FG1 Converter Efficiency vs. Output Current at Room Temperature

Characteristic Curves (continued)



8-2673 (F)

Figure 5. Typical HW050AF1 Output Ripple Voltage 5 V Output at Room Temperature and $I_o = I_{o, max}$, Different Input Voltage

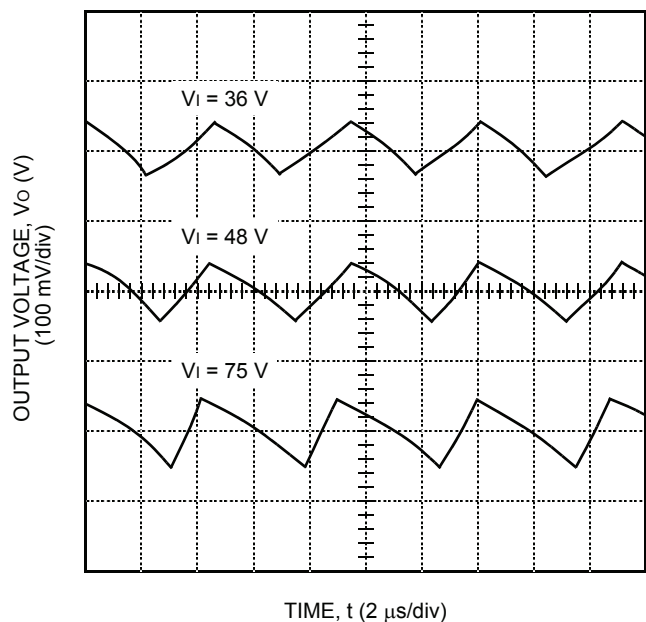

8-2674 (F)

Figure 6. Typical HW050AF1 Output Ripple Voltage 3.3 V Output at Room Temperature and $I_o = I_{o, max}$, Different Input Voltage

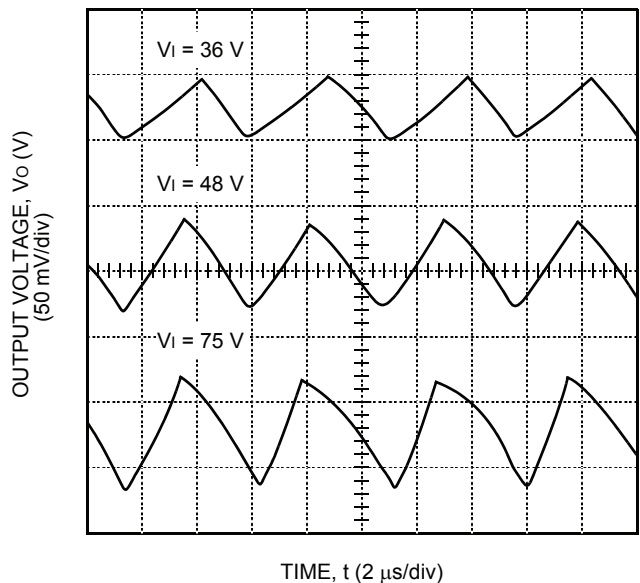

8-2593 (F)

Figure 7. Typical HW050FG1 Output Ripple Voltage 3.3 V Output at Room Temperature and $I_o = I_{o, max}$, Different Input Voltage

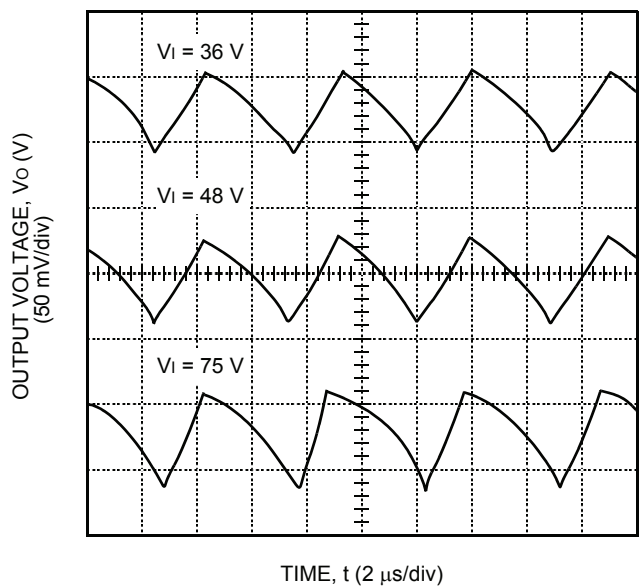

8-2594 (F)

Figure 8. Typical HW050FG1 Output Ripple Voltage 2.5 V at Room Temperature and $I_o = I_{o, max}$, Different Input Voltage

Characteristic Curves (continued)

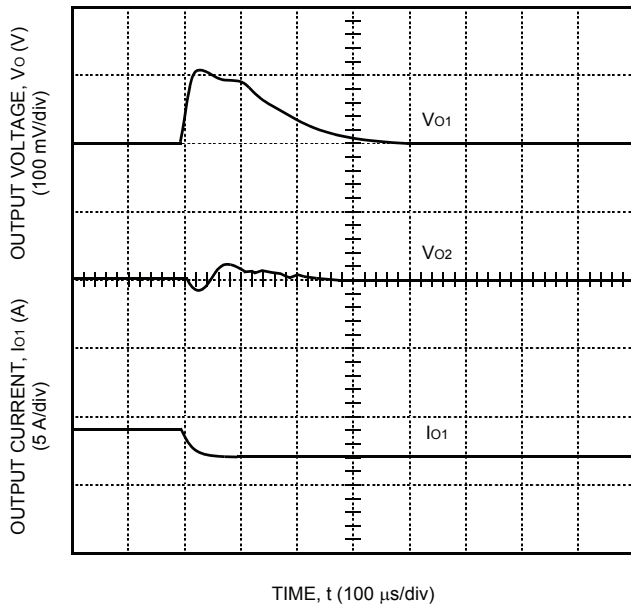

8-3085 (F)

Note: Tested without any load capacitance. Adding load capacitance will improve performance.

Figure 9. Typical HW050AF1 Transient Response to Step Decrease in Load, $I_{O1} = 50\%$ to 25% of $I_{O1, max}$, $I_{O2} = 30\%$ of $I_{O2, max}$, at Room Temperature and 48 V Input (Waveform Averaged to Eliminate Ripple Component.)

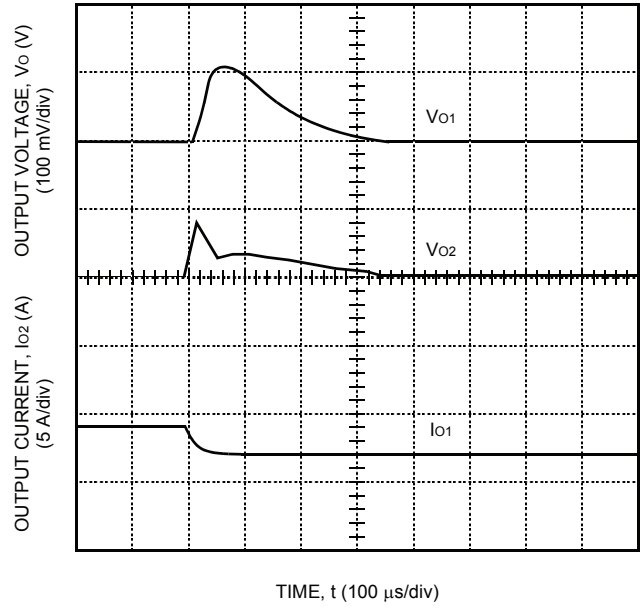

8-3086 (F)

Note: Tested without any load capacitance. Adding load capacitance will improve performance.

Figure 10. Typical HW050AF1 Transient Response to Step Decrease in Load, $I_{O2} = 50\%$ to 25% of $I_{O2, max}$, $I_{O1} = 30\%$ of $I_{O1, max}$, at Room Temperature and 48 V Input (Waveform Averaged to Eliminate Ripple Component.)

Characteristic Curves (continued)

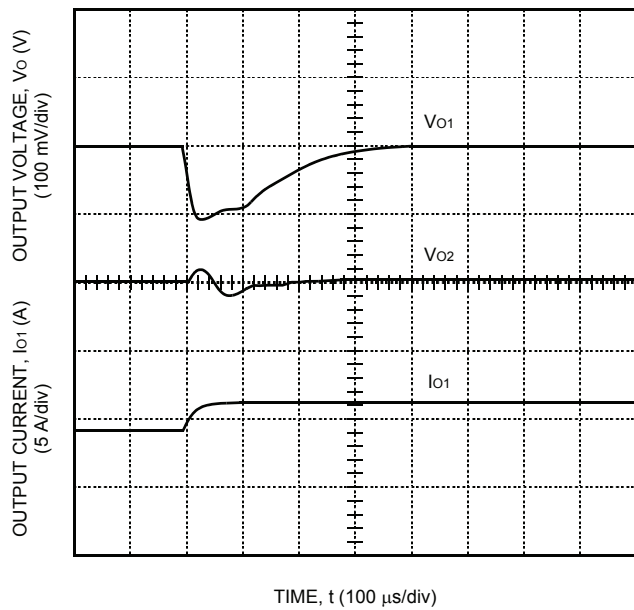

8-3087 (F)

Note: Tested without any load capacitance. Adding load capacitance will improve performance.

Figure 11. Typical HW050AF1 Transient Response to Step Increase in Load, $I_{o1} = 50\%$ to 75% of $I_{o1, \max}$, $I_{o2} = 30\%$ of $I_{o2, \max}$, at Room Temperature and 48 V Input (Waveform Averaged to Eliminate Ripple Component.)

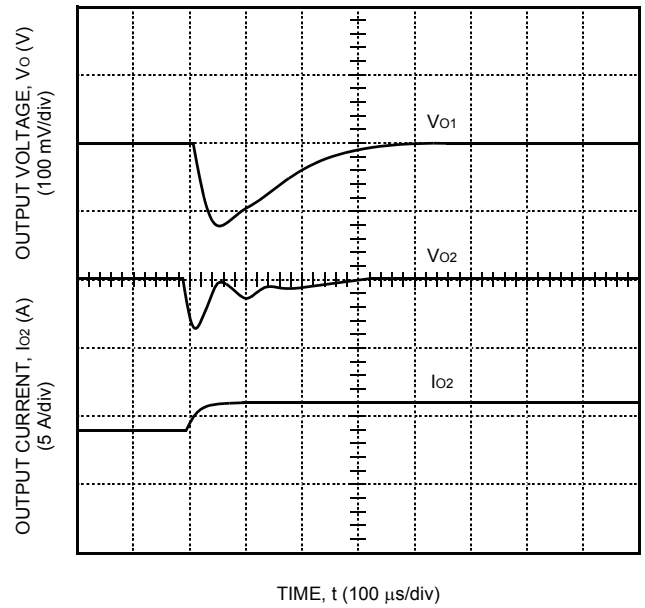

83088 (F)

Note: Tested without any load capacitance. Adding load capacitance will improve performance.

Figure 12. Typical HW050AF1 Transient Response to Step Increase in Load, $I_{o2} = 50\%$ to 75% of $I_{o2, \max}$, $I_{o1} = 30\%$ of $I_{o1, \max}$, at Room Temperature and 48 V Input (Waveform Averaged to Eliminate Ripple Component.)

Characteristic Curves (continued)

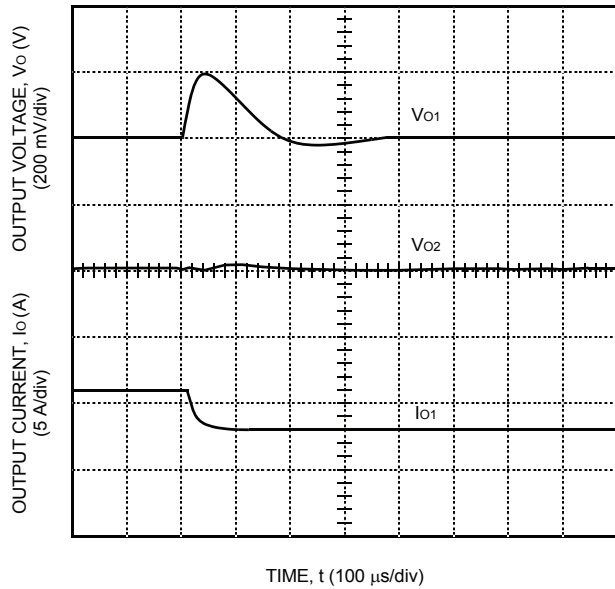

8-3089 (F)

Note: Tested without any load capacitance. Adding load capacitance will improve performance.

Figure 13. Typical HW050FG1 Transient Response to Step Decrease in Load, $I_{O1} = 50\%$ to 25% of $I_{O1,max}$, $I_{O2} = 30\%$ of $I_{O2,max}$, at Room Temperature and 48 V Input (Waveform Averaged to Eliminate Ripple Component.)

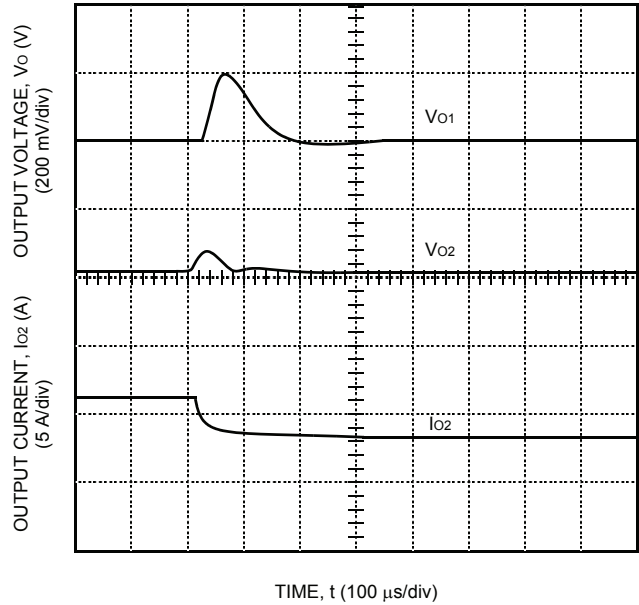

8-3090 (F)

Note: Tested without any load capacitance. Adding load capacitance will improve performance.

Figure 14. Typical HW050FG1 Transient Response to Step Decrease in Load, $I_{O2} = 50\%$ to 25% of $I_{O2,max}$, $I_{O1} = 30\%$ of $I_{O1,max}$, at Room Temperature and 48 V Input (Waveform Averaged to Eliminate Ripple Component.)

Characteristic Curves (continued)

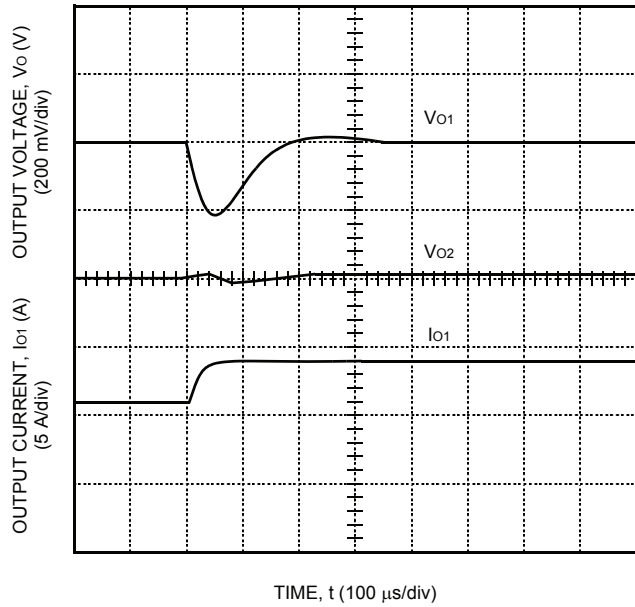

Note: Tested without any load capacitance. Adding load capacitance will improve performance.

Figure 15. Typical HW050FG1 Transient Response to Step Increase in Load, $I_{O1} = 50\%$ to 75% of $I_{O1, \max}$, $I_{O2} = 30\%$ of $I_{O2, \max}$, at Room Temperature and 48 V Input (Waveform Averaged to Eliminate Ripple Component.)

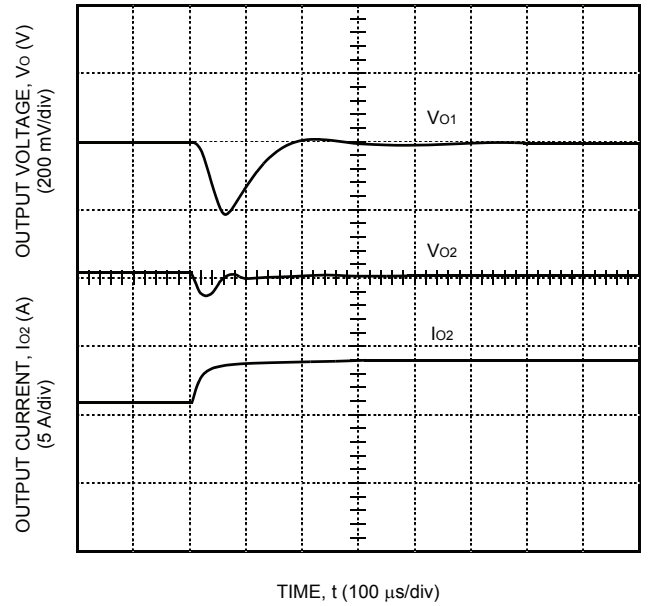

Note: Tested without any load capacitance. Adding load capacitance will improve performance.

Figure 16. Typical HW050FG1 Transient Response to Step Increase in Load, $I_{O2} = 50\%$ to 75% of $I_{O2, \max}$, $I_{O1} = 30\%$ of $I_{O1, \max}$, at Room Temperature and 48 V Input (Waveform Averaged to Eliminate Ripple Component.)

Characteristic Curves (continued)

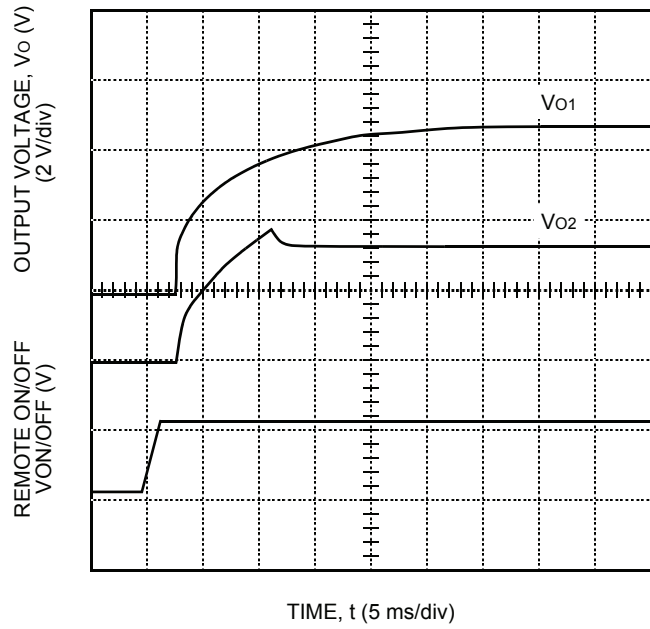

8-2679

Note: Tested without any load capacitance.

Figure 17. Typical Start-Up from Remote On/Off
HW050AF; $I_o = I_{o, max}$

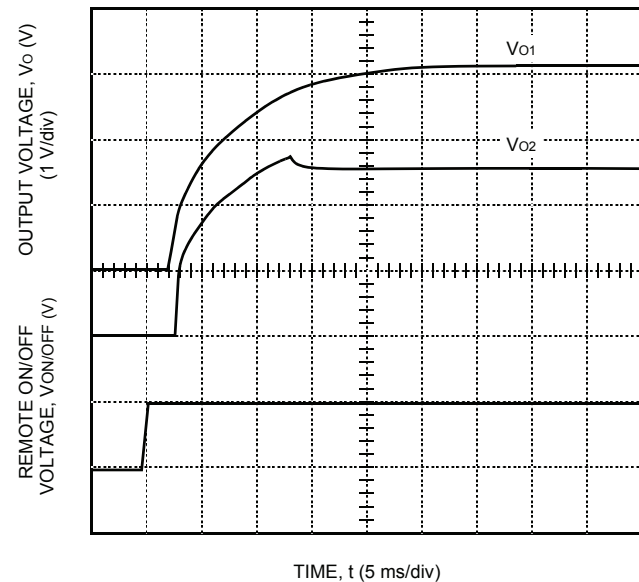

8-2599 (F)

Note: Tested without any load capacitance.

Figure 18. Typical Start-Up from Remote On/Off
HW050FG; $I_o = I_{o, max}$

Test Configurations

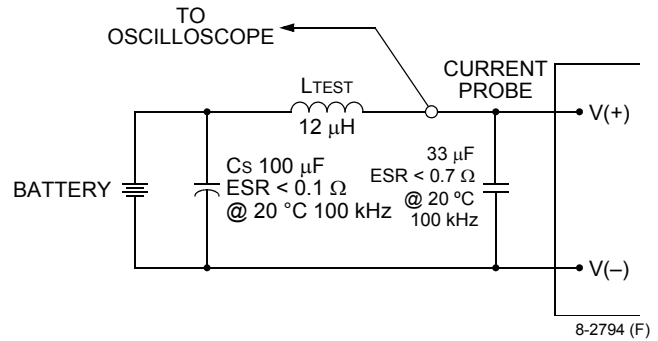

8-2794 (F)

Note: Measure input reflected-ripple current with a simulated source inductance (L_{TEST}) of 12 μ H. Capacitor C_s offsets possible battery impedance. Measure current as shown above.

Figure 19. Input Reflected-Ripple Test Setup

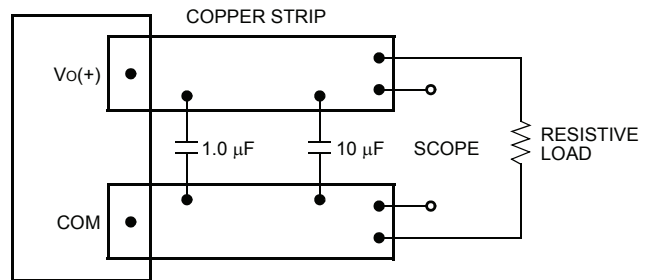

8-2795 (F)

Note: Use a 1.0 μ F ceramic capacitor and a 10 μ F aluminum or tantalum capacitor. Scope measurement should be made using a BNC socket. Position the load between 51 mm and 76 mm (2 in. and 3 in.) from the module.

Figure 20. Peak-to-Peak Output Noise Measurement Test Setup

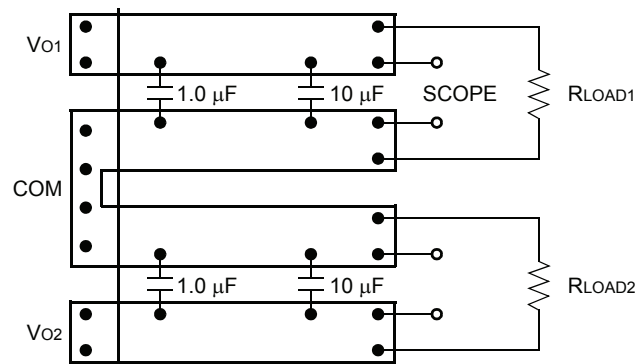

8-2796 (F)

Note: All measurements are taken at the module terminals. When socketing, place Kelvin connections at module terminals to avoid measurement errors due to socket contact resistance.

$$\eta = \left(\frac{[V_{O1(+)} - V_{O1(-)}]I_o + [V_{O2(+)} - V_{O2(-)}]I_o}{[V_i(+)-V_i(-)]I_i} \right) \times 100$$

Figure 21. Output Voltage and Efficiency Measurement Test Setup

Design Considerations

Input Source Impedance

The power module should be connected to a low ac-impedance input source. Highly inductive source impedances can affect the stability of the power module. For the test configuration in Figure 19, a 33 μF electrolytic capacitor (ESR < 0.7 Ω at 100 kHz) mounted close to the power module helps ensure stability of the unit. For other highly inductive source impedances, consult the factory for further application guidelines.

Safety Considerations

For safety-agency approval of the system in which the power module is used, the power module must be installed in compliance with the spacing and separation requirements of the end-use safety agency standard, i.e., *UL* 60950, *CSA* C22.2 No. 60950-00, *VDE* 0805 (IEC60950).

If the input source is non-SELV (ELV or a hazardous voltage greater than 60 Vdc and less than or equal to 75 Vdc), for the module's output to be considered meeting the requirements of safety extra-low voltage (SELV), all of the following must be true:

- The input source is to be provided with reinforced insulation from any other hazardous voltages, including the ac mains.
- One V_I pin and one V_O pin are to be grounded or both the input and output pins are to be kept floating.
- The input pins of the module are not operator accessible.
- Another SELV reliability test is conducted on the whole system, as required by the safety agencies, on the combination of supply source and the subject module to verify that under a single fault, hazardous voltages do not appear at the module's output.

Note: Do not ground either of the input pins of the module without grounding one of the output pins. This may allow a non-SELV voltage to appear between the output pins and ground.

The power module has extra-low voltage (ELV) outputs when all inputs are ELV.

For input voltages exceeding 60 Vdc but less than or equal to 75 Vdc, these converters have been evaluated to the applicable requirements of BASIC INSULATION between secondary DC MAINS DISTRIBUTION input (classified as TNV-2 in Europe) and unearthed SELV outputs.

The input to these units is to be provided with a maximum 6 A normal-blow fuse in the ungrounded lead.

Feature Descriptions

Overcurrent Protection

To provide protection in a fault (output overload) condition, the unit is equipped with internal current-limiting circuitry and can endure current limiting continuously. At the point of current-limit inception, the unit shifts from voltage control to current control. The form of current-limit used is hiccup mode. The unit operates normally once the output current is brought back into its specified range. Average output current during hiccup mode is 30% of $I_{O, \text{max}}$.

Remote On/Off

Two remote on/off options are available. Positive logic remote on/off turns the module on during a logic-high voltage on the ON/OFF pin, and off during a logic low. Negative logic remote on/off turns the module off during a logic high and on during a logic low. Negative logic, device code suffix "1," is the factory-preferred configuration.

To turn the power module on and off, the user must supply a switch to control the voltage between the on/off terminal and the $V_I(-)$ terminal ($V_{\text{on/off}}$). The switch can be an open collector or equivalent (see Figure 22). A logic low is $V_{\text{on/off}} = 0 \text{ V}$ to 1.2 V. The maximum $I_{\text{on/off}}$ during a logic low is 1 mA. The switch should maintain a logic-low voltage while sinking 1 mA.

During a logic high, the maximum $V_{\text{on/off}}$ generated by the power module is 6.1 V. The maximum allowable leakage current of the switch at $V_{\text{on/off}} = 6.1 \text{ V}$ is 50 μA .

If not using the remote on/off feature, do one of the following:

- For negative logic, short ON/OFF pin to $V_I(-)$.
- For positive logic, leave ON/OFF pin open.

Feature Descriptions (continued)

Remote On/Off (continued)

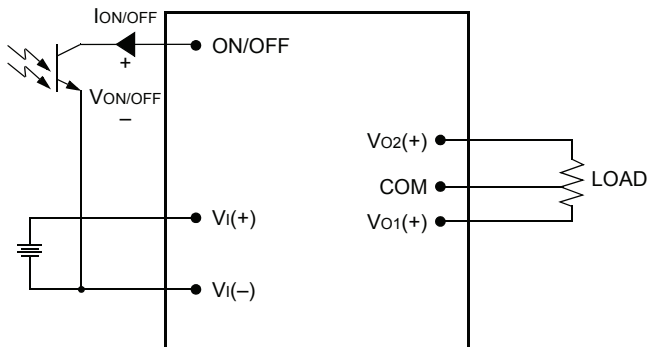

8-2800 (F)

Figure 22. Remote On/Off Implementation

Output Voltage Set-Point Adjustment (Trim)

Output voltage set point adjustment (trim) allows the output voltage set point to be increased or decreased. There are two trim pins, one for each output. The adjustment (trim) is accomplished by connecting an external resistor between the TRIM pin and either the Vo(+) pin or COM pin of the output to be adjusted. In order to maintain the output voltage set-point percentage accuracy, the trim resistor tolerance should be $\pm 0.1\%$. The trim resistor should be positioned close to the module.

If not using the trim feature, leave the TRIM pin(s) open.

Connecting an external resistor ($R_{\text{trim-down}}$) between the TRIM pin of the desired output and COM pin decreases the output voltage set point (see Figure 23). The following equations determine the required external-resistor value to obtain a percentage output voltage change of $\Delta\%$.

$$V_{O1} \quad R_{\text{adj-down}} = \left(\frac{511}{\Delta\%} - 6.11 \right) \text{ k}\Omega$$

$$V_{O2} \quad R_{\text{adj-down}} = \left(\frac{100}{\Delta\%} - 1.33 \right) \text{ k}\Omega$$

The test results for these configurations are displayed in Figure 24.

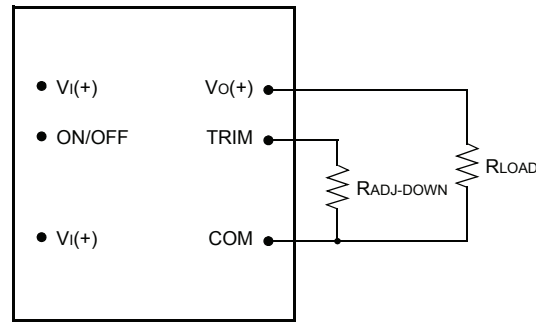

8-2798 (F)

Figure 23. Circuit Configuration to Decrease Output Voltage

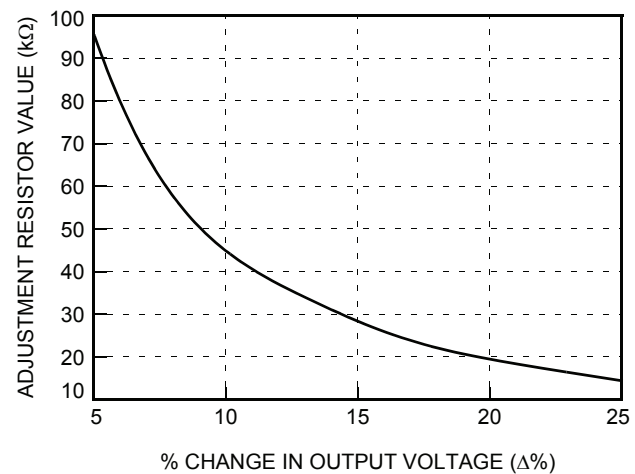

8-2680 (F)

Figure 24. Resistor Selection for Decreased Output Voltage for V01

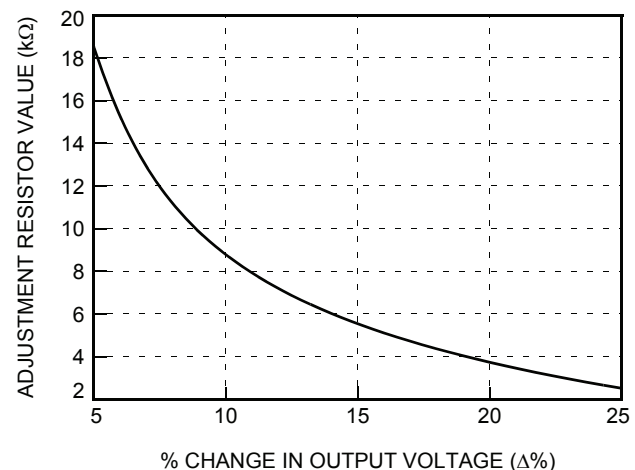

8-2681 (F)

Figure 25. Resistor Selection for Decreased Output Voltage for V02

Feature Descriptions (continued)

Output Voltage Set-Point Adjustment (Trim) (continued)

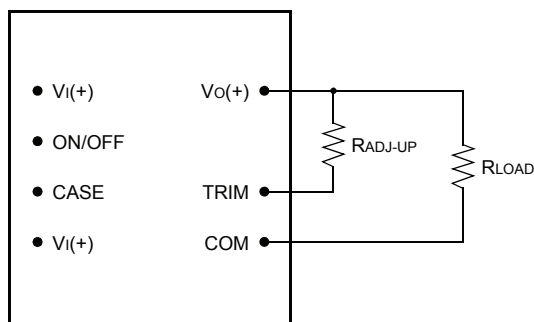

8-2797 (F)

Figure 26. Circuit Configuration to Increase Output Voltage

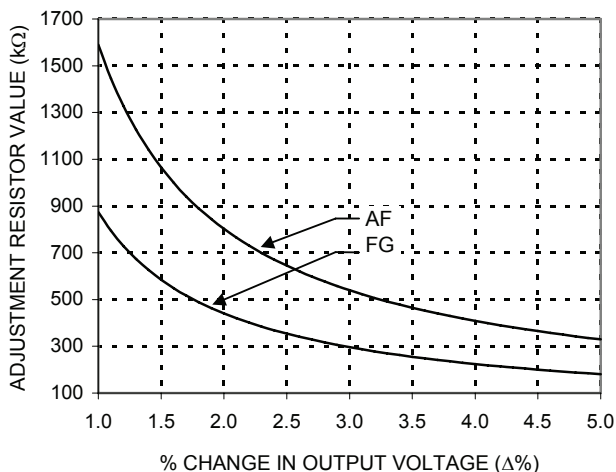

8-3093 (F)

Figure 27. Resistor Selection for Increased Output Voltage for V₀₁

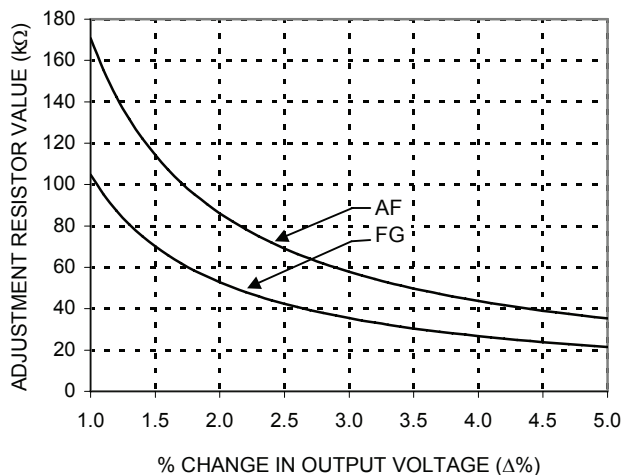

8-3094 (F)

Figure 28. Resistor Selection for Increased Output Voltage for V₀₂

Connecting an external resistor (R_{trim-up}) between the TRIM pin and V_o(+) pin of the desired output increases the output voltage set point (see Figure 26).

The following equation determines the required external-resistor value to obtain a percentage output voltage change of Δ%.

$$V_{O1} \quad R_{\text{trim-up}} = \left(\frac{5.11V_{O1}(100 + \Delta\%)}{1.225\Delta\%} - \frac{511}{\Delta\%} - 6.11 \right) \text{ k}\Omega$$

$$V_{O2} \quad R_{\text{trim-up}} = \left(\frac{V_{O2}(100 + \Delta\%)}{1.225\Delta\%} - \frac{100}{\Delta\%} - 1.33 \right) \text{ k}\Omega$$

The test results for these configurations are displayed in Figure 27.

Note: The following voltage range restrictions apply:

HW050AF:

For V₀₁ set to 5.0 V
V₀₂ range is 1.5 V to 3.46 V

HW050FG:

For V₀₁ set to 3.3 V
V₀₂ range is 1.5 V to 2.5 V

For V₀₁ set to 2.5 V
V₀₂ range is 1.5 V to 1.8 V

Note: The voltage between the V_o(+) and COM terminals must not exceed the minimum output over-voltage shutdown voltage as indicated in the Feature Specifications table.

Feature Descriptions (continued)

Output Voltage Set-Point Adjustment (Trim) (continued)

Consult the factory if you need to increase the output voltage more than the above limitation.

The amount of power delivered by the module is defined as the voltage at the output terminals multiplied by the output current. When using trim, the output voltage of the module can be increased, which at the same output current would increase the power output of the module. Care should be taken to ensure that the maximum output power of the module remains at or below the maximum rated power.

Output Overvoltage Protection

The output overvoltage protection consists of circuitry that monitors the voltage on the output terminals. If the voltage on the output terminals exceeds the overvoltage protection threshold, then the module will shut down and latch off. The overvoltage latch is reset by either cycling the input power for one second or by toggling the ON/OFF pin for one second.

Overtemperature Protection

To provide protection in a fault condition, the unit is equipped with a thermal shutdown circuit. The shutdown circuit will not engage unless the unit is operated above the maximum device temperature. Recovery for the thermal shutdown is accomplished by cycling the dc input power off for at least one second or toggling the primary referenced on/off signal for at least one second.

Thermal Considerations

The power modules operate in a variety of thermal environments; however, sufficient cooling should be provided to help ensure reliable operation of the unit. Heat is removed by convection and radiation to the surrounding environment.

The thermal data presented is based on measurements taken in a wind tunnel. The test setup shown in Figure 29 was used to collect data for Figure 32 through Figure 35. Note that the orientation of the module with respect to airflow affects thermal performance. Two orientations are shown in Figure 30 and Figure 31.

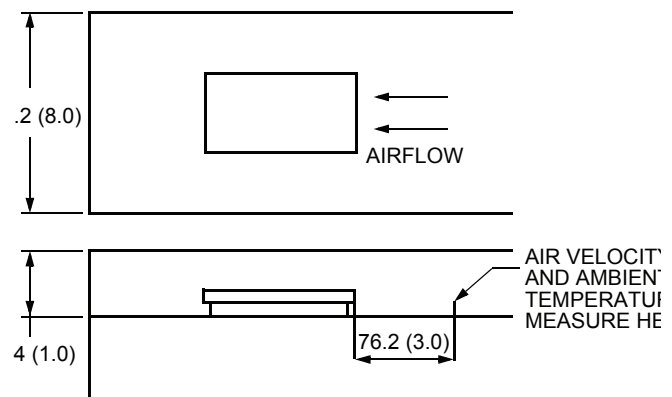

8-2603 (F)

Note: Dimensions are in millimeters and (inches).

Figure 29. Thermal Test Setup

Thermal Considerations (continued)

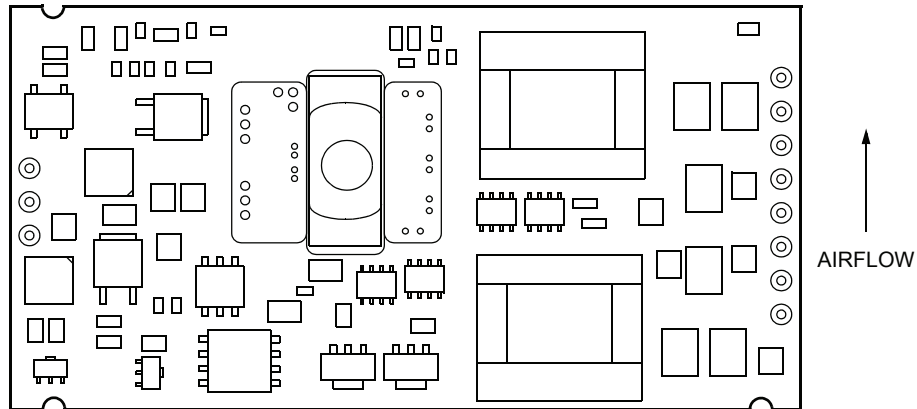

8-2604 (F)

Figure 30. Best Orientation (Top View)

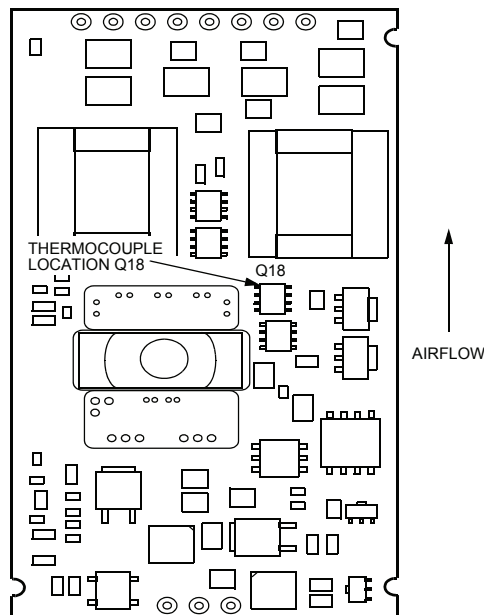

8-2605 (F)

Figure 31. Worst Orientation (Top View)

Proper cooling can be verified by measuring the power modules temperature at the top center of the case of the body of Q18 as shown in Figure 31.

The temperature at this location should not exceed 100 °C at full power. The output power of the module should not exceed the rated power.

Thermal Considerations (continued)

Convection Requirements for Cooling

To predict the approximate cooling needed for the module, determine the power dissipated as heat by the unit for the particular application. Figure 32 and Figure 33 show typical heat dissipation for the module over a range of output currents. $I_{O1} = I_{O2} = \frac{1}{2} I_O$ for Figure 32 and Figure 33.

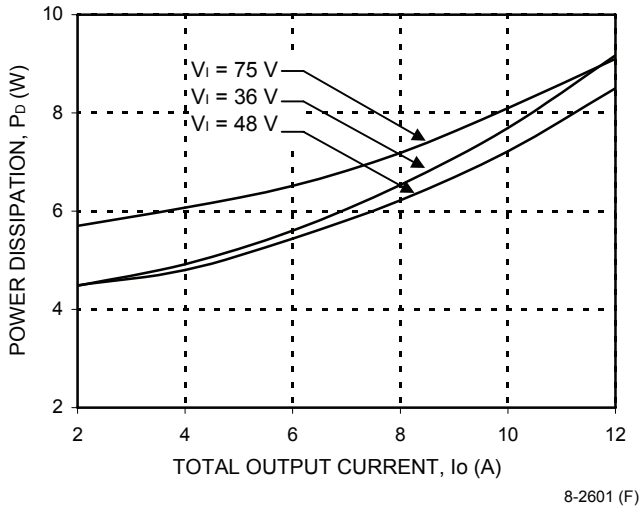

Figure 32. HW050AF1 Power Dissipation vs. Output Current, $T_A = 25\text{ }^\circ\text{C}$

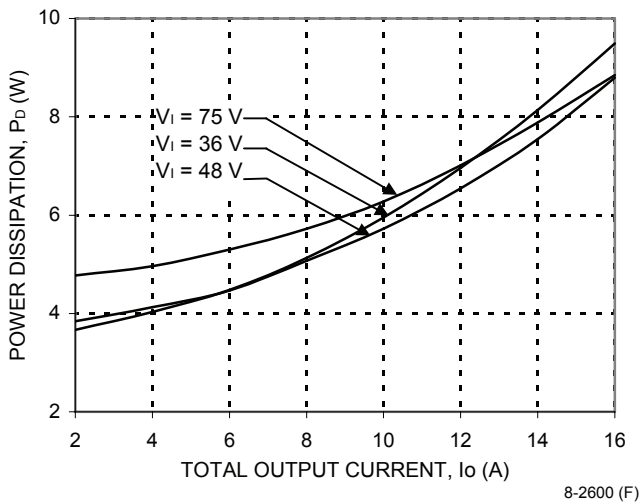

Figure 33. HW050FG1 Power Dissipation vs. Output Current, $T_A = 25\text{ }^\circ\text{C}$

With the known heat dissipation, module orientation with respect to airflow, and a given local ambient temperature, the minimum airflow can be chosen from the derating curves in Figure 34 through Figure 35.

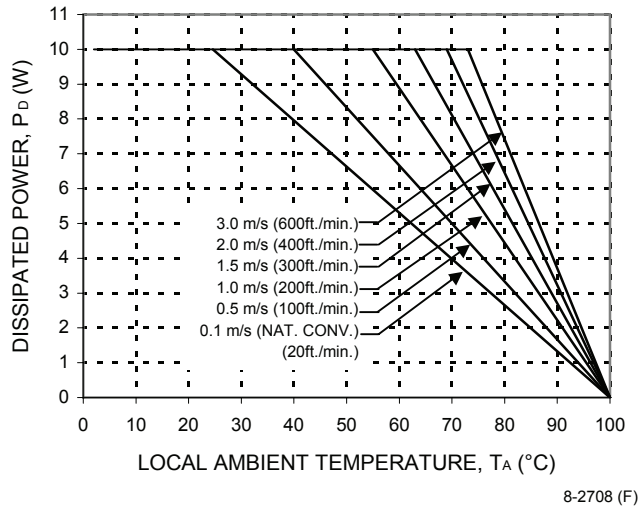

Figure 34. Power Derating vs. Local Ambient Temperature and Air Velocity; Best Orientation

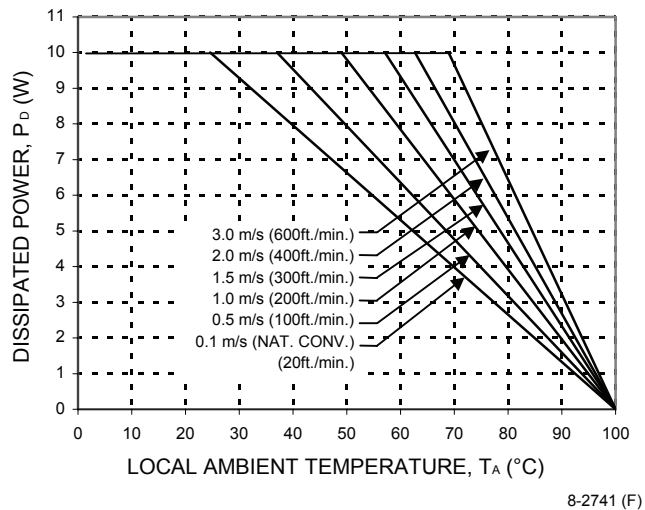

Figure 35. Power Derating vs. Local Ambient Temperature and Air Velocity; Worst Orientation

For example, if the HW050FG1 dissipates 7.5 W of heat at 14 A load and 48 V input voltage, the minimum airflow for best module orientation in a 65 °C environment is 1 m/s (200 ft./min.).

Keep in mind that these derating curves are approximations of the ambient temperatures and airflows required to keep the power module temperature below its maximum rating. Once the module is assembled in the actual system, the module's temperature should be checked to ensure it does not exceed 100 °C.

EMC Considerations

Figure 36 shows the suggested configuration to meet conducted limits of EN55022 Class B.

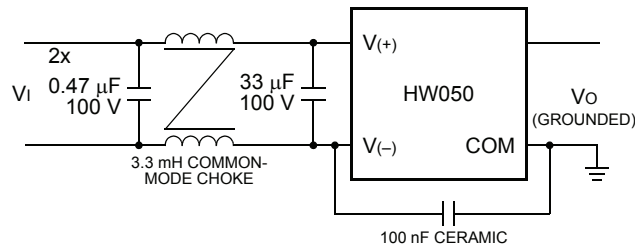

8-2684 (F)

Figure 36. Suggested Configuration for EN55022

For assistance with designing for EMC compliance, please refer to the FLTR100V10 data sheet (DS99-294EPS).

Layout Considerations

Copper paths must not be routed beneath the power module mounting inserts. For additional layout guidelines, refer to FLTR100V10 data sheet (DS99-294EPS).

Outline Diagram

Dimensions are in millimeters and (inches).

Tolerances: x.x mm ± 0.5 mm (x.xx in. ± 0.02 in.)
 x.xx mm ± 0.25 mm (x.xxx in. ± 0.010 in.)

Top View

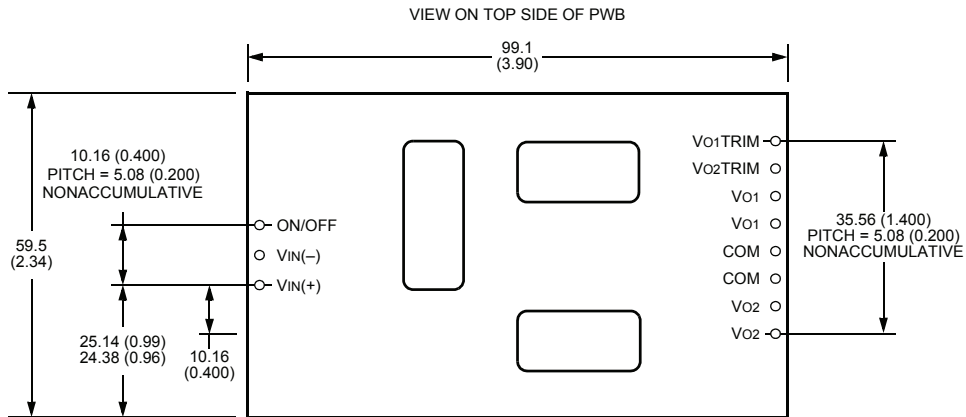

Side View

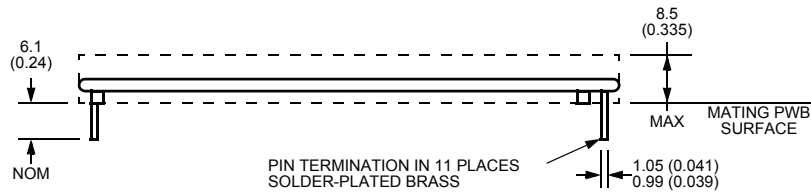

Bottom View

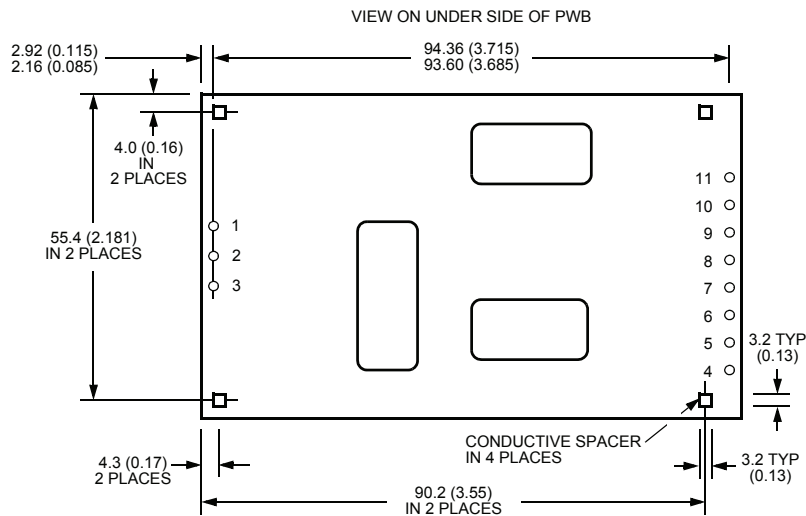

8-2799 (F)

Recommended Hole Pattern

Component-side footprint.

Dimensions are in millimeters and (inches).

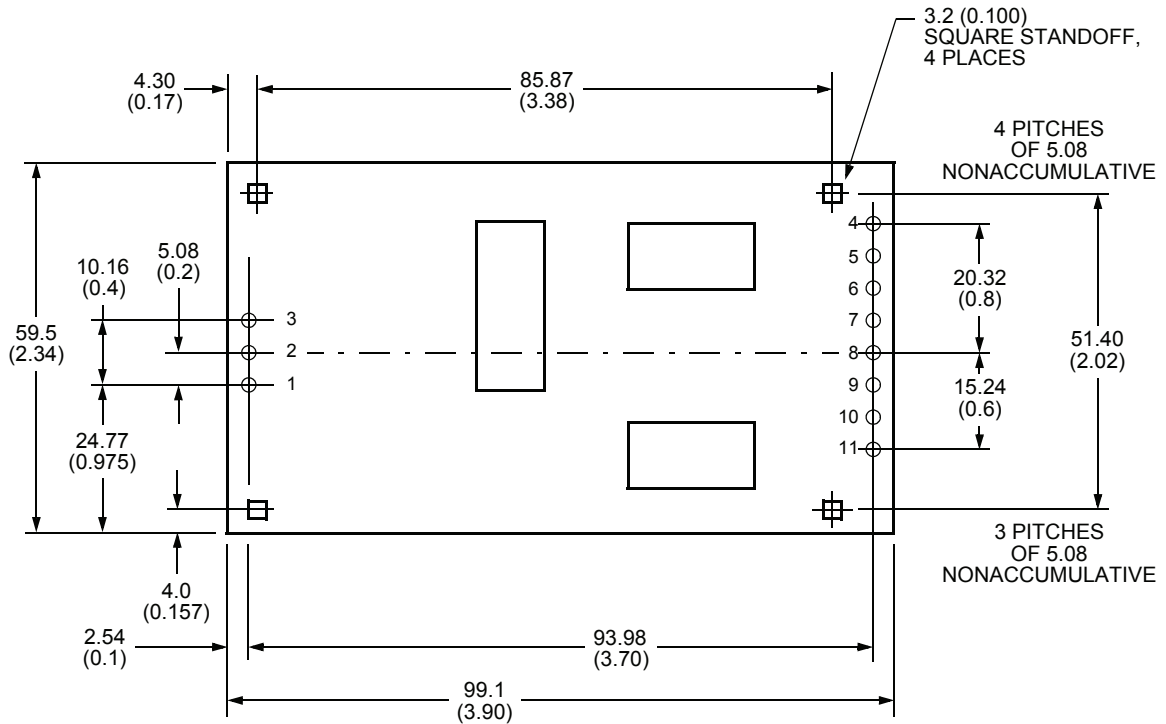

8-2607 (F)

Table 3. Pin Function

Pin	Function
1	Vi(+)
2	Vi(-)
3	ON/OFF
4	Vo1TRIM
5	Vo2TRIM
6	Vo1
7	Vo1
8	COM
9	COM
10	Vo2
11	Vo2

Ordering Information

Please contact your Lineage Power Account Manager or Field Application Engineer for pricing and availability.

Input Voltage	Output Voltage	Output Power	Device Code	Comcode
48 V	5.0 V and 3.3 V	53.2 W	HW050AF	108365610
48 V	5.0 V and 3.3 V	53.2 W	HW050AF1	TBD
48 V	5.0 V and 3.3 V	53.2 W	HW050AF6	108958240
48 V	3.3 V and 2.5 V	49.6 W	HW050FG	108341710
48 V	3.3 V and 2.5 V	49.6 W	HW050FG1	TBD
48 V	3.3 V and 2.5 V	49.6 W	HW050FG6	108891680
48 V	3.3 V and 2.5 V	49.6 W	HW050FG8	108934233
48 V	3.3 V and 2.5 V	49.6 W	HW050FG-B	108840190

Optional features may be chosen from the device code suffixes shown below. The feature suffixes are listed numerically in descending order. Please contact your Lineage Power Account Manager or Application Engineer for pricing and availability of options.

Option	Device Code Suffix
Short pins: 2.79 mm +0.5/-0.25 mm (0.110 in. + 0.020/-0.010 in.)	8
Short pins: 3.81 mm +0.5/-0.25 mm (0.110 in. + 0.020/-0.010 in.)	6
Negative remote on/off logic	1

Notes



LINEAGE POWER

World Wide Headquarters

Lineage Power Corporation

3000 Skyline Drive, Mesquite, TX 75149, USA

+1-800-526-7819

(Outside U.S.A.: **+1-972-284-2626**)

www.lineagepower.com

e-mail: techsupport1@lineagepower.com

Asia-Pacific Headquarters

Tel: +65 6416 4283

Europe, Middle-East and Africa Headquarters

Tel: +49 89 6089 286

India Headquarters

Tel: +91 80 28411633

Lineage Power reserves the right to make changes to the product(s) or information contained herein without notice. No liability is assumed as a result of their use or application. No rights under any patent accompany the sale of any such product(s) or information.

© 2008 Lineage Power Corporation, (Mesquite, Texas) All International Rights Reserved.

April 2008

FDS01-029EPS (Replaces FDS01-028EPS)