

## QRW010/025/035/040 Series Power Modules; dc-dc Converters 36 Vdc - 75 Vdc Input, 1.0 to 12 Vdc Output; 10 A to 40 A

### RoHS Compliant



### Applications

- Enterprise Networks
- Wireless Networks
- Access and Optical Network Equipment
- Enterprise Networks
- Latest generation IC's (DSP, FPGA, ASIC) and Microprocessor-powered applications.

### Options

- Positive Remote On/Off logic
- Case ground pin (-H Base plate version)
- Auto restart after fault shutdown

### Description

The QRW-series dc-dc converters are a new generation of DC/DC power modules designed for optimum efficiency and power density. The QRW series provide up to 40A output current in an industry standard quarter brick, which makes it an ideal choice for small space, high current and low voltage applications. The converter uses synchronous rectification technology and innovative packaging techniques to achieve ultra high efficiency reaching 91% at 3.3V full load. Thanks to the ultra high efficiency of this converter, the power dissipation is such that for most applications a heat sink is not required. In addition, the QRW-series supports future migration of semiconductor and microprocessor supply voltages down to 1.0V.

### Features

- Compatible with RoHS EU Directive 2002/95/EC (-Z Versions)
- Compatible in RoHS EU Directive 2002/95/EC with lead solder exemption (non -Z versions)
- Delivers up to 40A output current
- Ultra High efficiency: 91% at 3.3V full load
- Industry standard Quarter Brick:  
57.9 mm x 36.8 mm x 9.5 mm  
(2.28 in x 1.45 in x 0.375 in)
- Improved Thermal performance  
23A at 70°C at 1ms-1 (200LFM) for 3.3Vo
- High power density: 100W/in<sup>3</sup>
- Low output ripple and noise
- Low output voltages down to 1V:  
Supports migration to future IC and microprocessor supply voltages
- 2:1 input voltage
- Remote Sense
- Remote On/Off
- Constant switching frequency
- Output overvoltage and Overcurrent protection
- Overtemperature protection
- Adjustable output voltage (+10% / -20%)
- Meets the voltage and current requirements for ETSI 300-132-2 and complies with and is approved for Basic Insulation rating per EN60950-1
- UL\* 60950 Recognized, CSA† C22.2 No. 60950-00 Certified, and VDE‡ 0805 (IEC60950, 3rd edition) Licensed
- CE mark meets 73/23/EEC and 93/68/EEC directives§
- ISO\*\* 9001 certified manufacturing facilities

\* UL is a registered trademark of Underwriters Laboratories, Inc.

† CSA is a registered trademark of Canadian Standards Association.

‡ VDE is a trademark of Verband Deutscher Elektrotechniker e.V.

§ This product is intended for integration into end-use equipment. All the required procedures for CE marking of end-use equipment should be followed. (The CE mark is placed on selected products.)

\*\* ISO is a registered trademark of the International Organization of Standards

## Absolute Maximum Ratings

Stresses in excess of the absolute maximum ratings can cause permanent damage to the device. These are absolute stress ratings only, functional operation of the device is not implied at these or any other conditions in excess of those given in the operations sections of the data sheet. Exposure to absolute maximum ratings for extended periods can adversely affect the device reliability.

| Parameter   | Device | Symbol          | Min         | Max        | Unit       |
|---|--------|-----------------|-------------|------------|------------|
| Input Voltage:Continuous<br>Transient (100ms)   | All    | VI<br>VI, trans | —<br>—      | 80<br>100  | Vdc<br>Vdc |
| Operating Ambient Temperature<br>(See Thermal Considerations section)                                   | All    | TA              | -40         | 85         | °C         |
| Storage Temperature   | All    | Tstg            | -55         | 125        | °C         |
| I/O Isolation Voltage (100% factory Hi-Pot tested)<br>When using optional case ground pin<br>(option 7) | —      | —               | 1500<br>700 | Vdc<br>Vdc |            |

## Electrical Specifications

Unless otherwise indicated, specifications apply over all operating input voltage, resistive load, and temperature conditions.

| Parameter  | Device | Symbol | Min | Typ | Max | Unit             |
|--|--------|--------|-----|-----|-----|------------------|
| Operating Input Voltage  | All    | VIN    | 36  | 48  | 75  | Vdc              |
| Maximum Input Current<br>(VI = 0 V to 75 V; IO = IO, max)  | All    |        | —   | —   | 4.5 | Adc              |
| Inrush Transient   | All    | $I^2t$ |     |     | 1   | A <sup>2</sup> s |
| Input Reflected Ripple Current, peak-peak<br>(5 Hz to 20 MHz, 12 $\mu$ H source impedance<br>See Test configuration section) | All    |        |     | 16  |     | mAp-p            |
| Input Ripple Rejection (120 Hz)  | All    |        |     | 60  |     | dB               |

**CAUTION: This power module is not internally fused. An input line fuse must always be used.**

This power module can be used in a wide variety of applications, ranging from simple stand-alone operation to an integrated part of a sophisticated power architecture. To preserve maximum flexibility, internal fusing is not included; however, to achieve maximum safety and system protection, always use an input line fuse. The safety agencies require a normal-blow fuse with a maximum rating of 10 A (see Safety Considerations section). Based on the information provided in this data sheet on inrush energy and maximum dc input current, the same type of fuse with a lower rating can be used. Refer to the fuse manufacturer's data for further information.

## Electrical Specifications (continued)

### Output Specifications for the QRW040A0S1R0 (Vo = 1.0Vdc)

| Parameter  | Device      | Symbol      | Min         | Typ                          | Max              | Unit                         |
|--|-------------|-------------|-------------|------------------------------|------------------|------------------------------|
| Output Voltage Set Point<br>(VI = 48 Vdc; IO = IO, min to IO, max, TA = 25 °C)   | P           | Vo          | 0.99        | 1.0                          | 1.01             | Vdc                          |
| Output Voltage<br>(Over all operating input voltage, resistive load, and temperature conditions at steady state until end of life.)  | P           | Vo          | 0.98        | —                            | 1.02             | Vdc                          |
| Output Regulation:<br>Line (VI = VI, min to VI, max)<br>Load (IO = IO, min to IO, max)<br>Temperature (TA = TA, min to TA, max)  | P           | —<br>—<br>— | —<br>—<br>— | 0.1<br>0.1<br>15             | 0.3<br>0.3<br>50 | % VO, set<br>% VO, set<br>mV |
| Output Ripple and Noise<br>RMS (5 Hz to 20 MHz bandwidth)<br>Peak-to-peak (5 Hz to 20 MHz bandwidth)   | P           |             | —<br>—      | —<br>—                       | 30<br>80         | mVrms<br>mVp-p               |
| External Load Capacitance  |             |             |             | —                            | 25,000           | µF                           |
| Output Current<br>(Vo = 90% of VO, nom.)   | P           | IO          | 0.0         | —                            | 40               | Adc                          |
| Output Current-limit Inception<br>(VO = 90% of VO, set)  | P           | IO, lim     | —           | 49                           | —                | Adc                          |
| Output Short-circuit Current (Average) VO = 0.25 V   | Latched off |             |             |                              |                  |                              |
| Efficiency<br>(VI = VIN, nom; IO = IO, max), TA = 25 °C  |             | η           | —           | 83                           | —                | %                            |
| Switching Frequency  | All         | fSW         | —           | 300                          | —                | kHz                          |
| Dynamic Response<br>(DIO/Dt = 1 A/10 µs, VI = 48 V, TA = 25 °C); tested with a 220 µF aluminium and a 1.0 µF ceramic capacitor across the load.):<br>Load Change from IO = 50% to 75% of IO, max:<br>Peak Deviation<br>Settling Time (VO < 10% of peak deviation)<br>Load Change from IO = 50% to 25% of IO, max :<br>Peak Deviation<br>Settling Time (VO < 10% of peak deviation) |             |             |             | 160<br>200<br><br>180<br>200 |                  | mV<br>µs<br><br>mV<br>µs     |

## Isolation Specifications

| Parameter             | Symbol | Min | Typ  | Max | Unit |
|-----------------------|--------|-----|------|-----|------|
| Isolation Capacitance | Ciso   | —   | 5600 | —   | PF   |
| Isolation Resistance  | Riso   | 10  | —    | —   | MΩ   |

## General Specifications

| Parameter  | Min | Typ       | Max | Unit    |
|--|-----|-----------|-----|---------|
| Calculated MTBF (Io = 80% of Io, max Ta = 40 °C, Method I, Case 1) |     | 1,219,777 |     | Hours   |
| Weight   | —   | 37(1.31)  | —   | g (oz.) |

## Feature Specifications

Unless otherwise indicated, specifications apply over all operating input voltage, resistive load, and temperature conditions. See Feature Descriptions for additional information.

| Parameter  | Symbol                                   | Min              | Typ              | Max                         | Unit                          |
|--|--|------------------|------------------|-----------------------------|-------------------------------|
| Remote On/Off Signal Interface*<br>(VI = 0 V to 75 V; open collector or equivalent compatible; signal referenced to VI(-) terminal; see Figure 52 and Feature Descriptions.):<br>Preferred Logic:<br>Logic Low—Module On<br>Logic High—Module Off<br>Optional Logic:<br>Logic Low—Module Off<br>Logic High—Module On<br>Logic Low:<br>At Ion/off = 1.0 mA<br>At Von/off = 0.0 V<br>Logic High:<br>At Ion/off = 0.0 $\mu$ A<br>Leakage Current<br>Turn-on Time; see Typical Start-up Curve (IO = IO max;<br>Vo within $\pm$ 1% of steady state) | Von/off<br>Ion/off<br>Von/off<br>Ion/off | 0<br>—<br>—<br>— | —<br>—<br>—<br>2 | 1.2<br>1.0<br>15<br>50<br>4 | V<br>mA<br>V<br>$\mu$ A<br>ms |
| Output Voltage Adjustment<br>(See Feature Descriptions):<br>Output Voltage Remote-sense Range<br>Output Voltage Set-point Adjustment Range (trim)  | —<br>—                                   | —<br>80          | —<br>—           | 10<br>110                   | %VO, rated<br>%VO, nom        |
| Output Overvoltage Protection  | VO, ovsd                                 | 1.25             | —                | 1.5                         | V                             |
| Overtemperature Protection (IO = IO, max)  | Tref1                                    | —                | 127              | —                           | $^{\circ}$ C                  |

## Characteristic Curves

The following figures provide typical characteristics curves for the QRW040A0S1R0 ( $V_O = 1.0\text{ V}$ ) module at room temperature ( $T_A = 25\text{ }^\circ\text{C}$ ). The figures are identical for both on/off configurations.

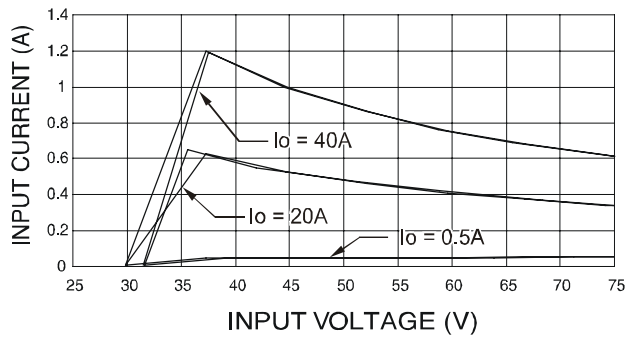

Figure 1. Input Voltage and Current Characteristics.

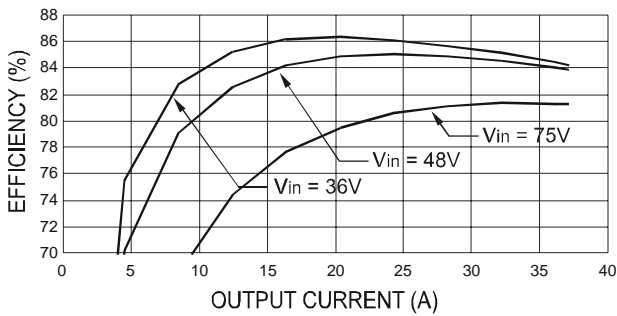

Figure 2. Converter Efficiency vs. Output Current.

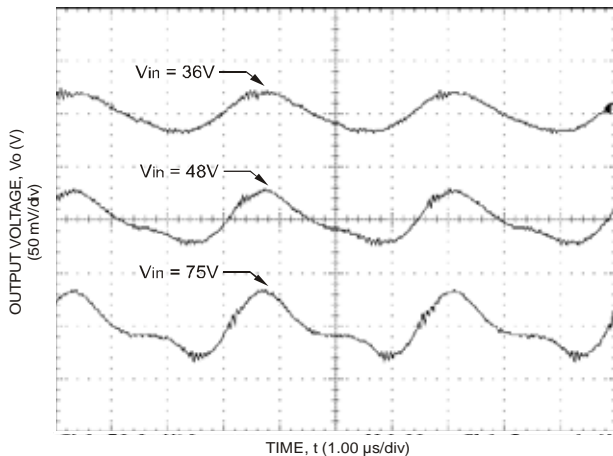
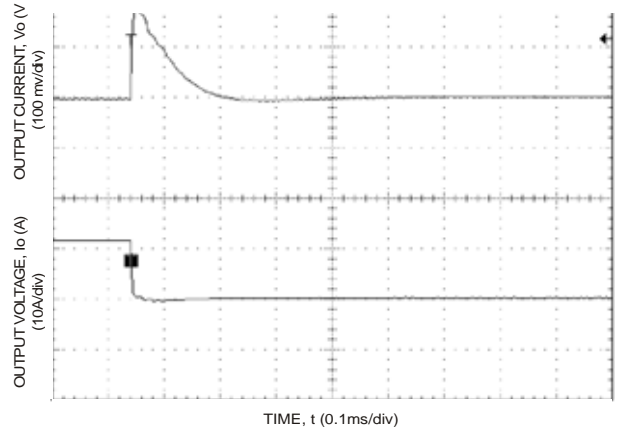

Figure 3. Output Ripple Voltage ( $I_O = I_{O, \text{max}}$ ).

Lineage Power



Tested with a  $220\mu\text{F}$  aluminium and a  $1.0\mu\text{F}$  ceramic capacitor across the load.

Figure 4. Transient Response to Step decrease in Load from 50% to 25% of Full Load ( $V_I = 48\text{ Vdc}$ ).

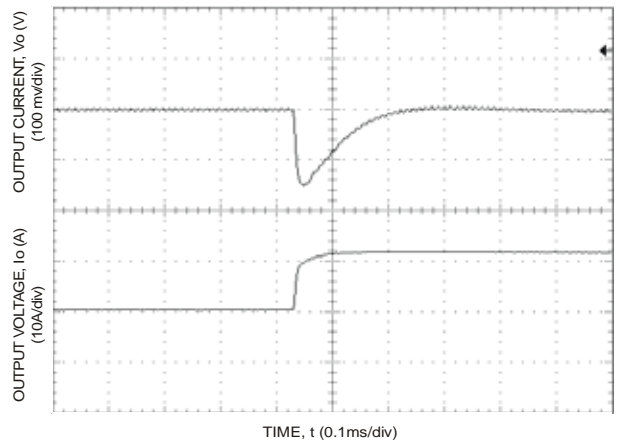

Figure 5. Transient Response to Step Increase in Load from 50% to 75% of Full Load ( $V_I = 48\text{ Vdc}$ ).

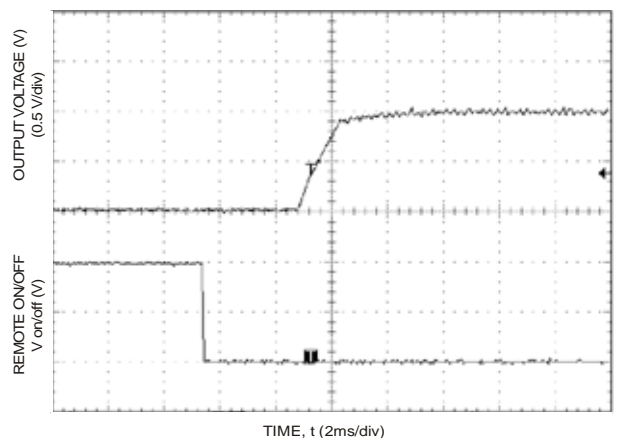

Figure 6. Start-up from Remote On/Off ( $I_O = I_{O, \text{max}}$ ).

## Electrical Specifications (continued)

### Output Specifications for the QRW040AP (Vo = 1.2Vdc)

| Parameter  | Device      | Symbol      | Min         | Typ                          | Max              | Unit                         |
|--|-------------|-------------|-------------|------------------------------|------------------|------------------------------|
| Output Voltage Set Point<br>(VI = 48 Vdc; IO = IO, min to IO, max, TA = 25 °C)   | P           | Vo          | 1.18        | 1.2                          | 1.22             | Vdc                          |
| Output Voltage<br>(Over all operating input voltage, resistive load, and temperature conditions at steady state until end of life.)  | P           | Vo          | 1.16        | —                            | 1.24             | Vdc                          |
| Output Regulation:<br>Line (VI = VI, min to VI, max)<br>Load (IO = IO, min to IO, max)<br>Temperature (TA = TA, min to TA, max)  | P           | —<br>—<br>— | —<br>—<br>— | 0.05<br>0.05<br>15           | 0.3<br>0.3<br>50 | % VO, set<br>% VO, set<br>mV |
| Output Ripple and Noise<br>RMS (5 Hz to 20 MHz bandwidth)<br>Peak-to-peak (5 Hz to 20 MHz bandwidth)   | P           |             | —<br>—      | —<br>—                       | 30<br>80         | mVrms<br>mVp-p               |
| External Load Capacitance  |             |             |             | —                            | 25,000           | µF                           |
| Output Current<br>(Vo = 90% of VO, nom.)   | P           | IO          | 0.0         | —                            | 40               | Adc                          |
| Output Current-limit Inception<br>(VO = 90% of VO, set)  | P           | IO, lim     | —           | 45                           | —                | Adc                          |
| Output Short-circuit Current (Average) VO = 0.25 V   | Latched off |             |             |                              |                  |                              |
| Efficiency<br>(VI = VIN, nom; IO = IO, max), TA = 25 °C  |             | η           | —           | 85                           | —                | %                            |
| Switching Frequency  | All         | fSW         | —           | 300                          | —                | kHz                          |
| Dynamic Response<br>(DIO/Dt = 1 A/10 µs, VI = 48 V, TA = 25 °C); tested with a 220 µF aluminium and a 1.0 µF ceramic capacitor across the load.):<br>Load Change from IO = 50% to 75% of IO, max:<br>Peak Deviation<br>Settling Time<br>(VO < 10% of peak deviation)<br>Load Change from IO = 50% to 25% of IO, max :<br>Peak Deviation<br>Settling Time<br>(VO < 10% of peak deviation) |             |             |             | 120<br>200<br><br>120<br>200 |                  | mV<br>µs<br><br>mV<br>µs     |

## Isolation Specifications

| Parameter             | Symbol | Min | Typ  | Max | Unit |
|-----------------------|--------|-----|------|-----|------|
| Isolation Capacitance | Ciso   | —   | 5600 | —   | PF   |
| Isolation Resistance  | Riso   | 10  | —    | —   | MΩ   |

## General Specifications

| Parameter  | Min | Typ      | Max | Unit    |
|--|-----|----------|-----|---------|
| Calculated MTBF (IO = 80% of IO, max TA = 40 °C) |     | 1,71,000 |     | Hours   |
| Weight   | —   | 37(1.31) | —   | g (oz.) |

## Feature Specifications

Unless otherwise indicated, specifications apply over all operating input voltage, resistive load, and temperature conditions. See Feature Descriptions for additional information.

| Parameter   | Symbol                                   | Min              | Typ              | Max                         | Unit                     |
|---|--|------------------|------------------|-----------------------------|--------------------------|
| Remote On/Off Signal Interface*<br>(VI = 0 V to 75 V; open collector or equivalent compatible; signal referenced to VI(-) terminal; see Figure 52 and Feature Descriptions.):<br>Preferred Logic:<br>Logic Low—Module On<br>Logic High—Module Off<br>Optional Logic:<br>Logic Low—Module Off<br>Logic High—Module On<br>Logic Low:<br>At Ion/off = 1.0 mA<br>At Von/off = 0.0 V<br>Logic High:<br>At Ion/off = 0.0 μA<br>Leakage Current<br>Turn-on Time; see Typical Start-up Curve (IO = IO max; Vo within ±1% of steady state) | Von/off<br>Ion/off<br>Von/off<br>Ion/off | 0<br>—<br>—<br>— | —<br>—<br>—<br>2 | 1.2<br>1.0<br>15<br>50<br>4 | V<br>mA<br>V<br>μA<br>ms |
| Output Voltage Adjustment<br>(See Feature Descriptions):<br>Output Voltage Remote-sense Range<br>Output Voltage Set-point Adjustment Range (trim)   | —<br>—                                   | —<br>80          | —<br>—           | 10<br>110                   | %VO, rated<br>%VO, nom   |
| Output Overvoltage Protection   | VO, ovsd                                 | 1.42             | —                | 1.58                        | V                        |
| Overtemperature Protection (IO = IO, max)   | Tref1                                    | —                | 127              | —                           | °C                       |

\* A Minimum OFF Period of 1 sec is recommended.

## Characteristic Curves

The following figures provide typical characteristics curves for the QRW040A0P ( $V_O = 1.2\text{ V}$ ) module at room temperature ( $T_A = 25\text{ }^\circ\text{C}$ )

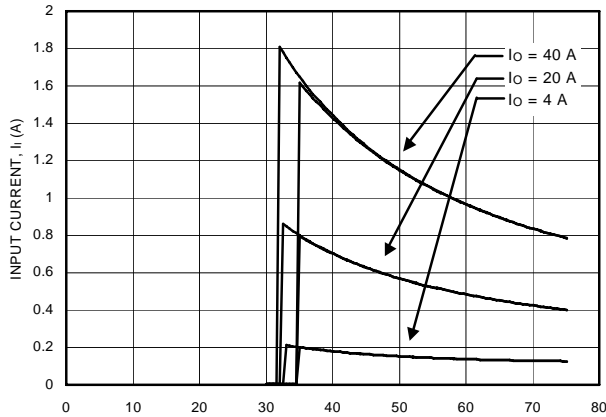

Figure 7. Input Voltage and Current Characteristics.

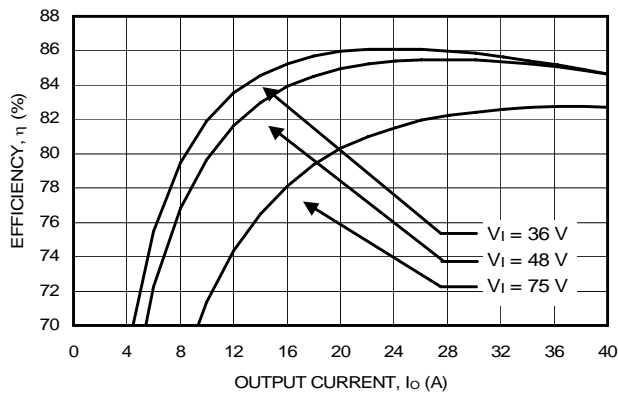

Figure 8. Converter Efficiency vs. Output Current.

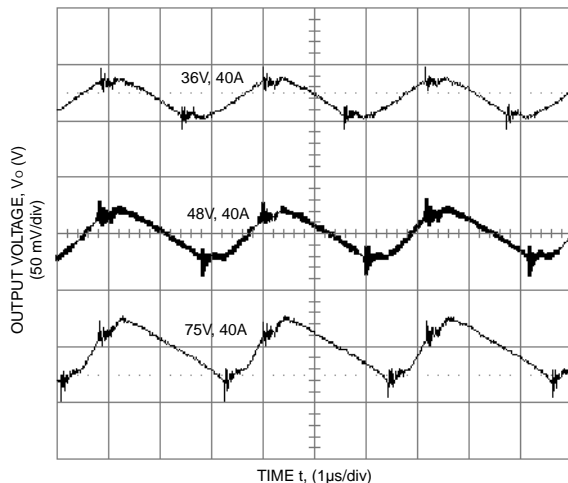
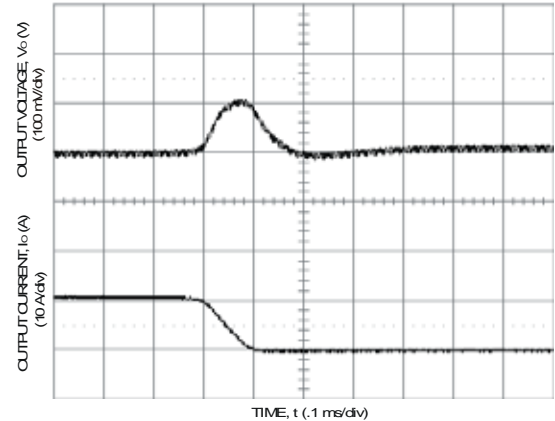

Figure 9. Output Ripple Voltage ( $I_O = I_{O, \text{max}}$ ).

Lineage Power



Tested with a  $220\mu\text{F}$  aluminium and a  $1.0\mu\text{F}$  ceramic capacitor across the load.

Figure 10. Transient Response to Step Decrease in Load from 50% to 25% of Full Load ( $V_I = 48\text{ Vdc}$ ).

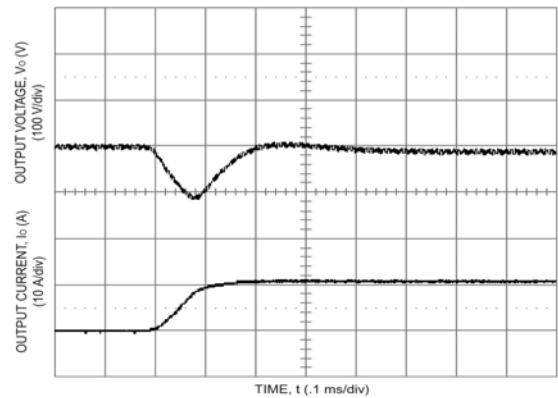
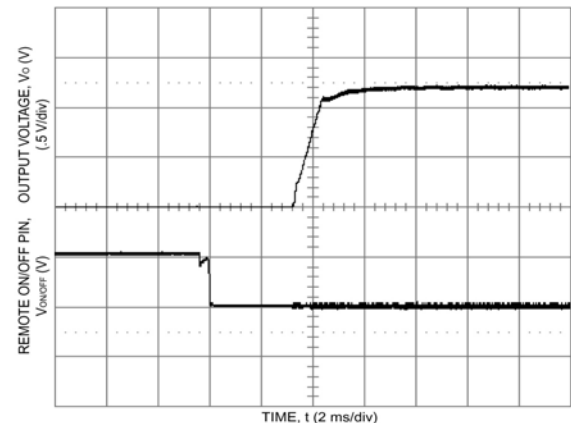

Figure 11. Transient Response to Step Increase in Load from 50% to 75% of Full Load ( $V_I = 48\text{ Vdc}$ ).



Tested with a  $10\mu\text{F}$  aluminium and a  $1.0\mu\text{F}$  tantalum capacitor across the load.

Figure 12. Start-up from Remote On/Off ( $I_O = I_{O, \text{max}}$ ).



## Electrical Specifications (continued)

### Output Specifications for the QRW040AOM (Vo = 1.5Vdc)

| Parameter  | Device      | Symbol      | Min         | Typ                | Max                          | Unit                           |
|--|-------------|-------------|-------------|--------------------|------------------------------|--------------------------------|
| Output Voltage Set Point<br>(VI = 48 Vdc; IO = IO, min to IO, max, TA = 25 °C)   | M           | Vo          | 1.47        | 1.5                | 1.52                         | Vdc                            |
| Output Voltage<br>(Over all operating input voltage, resistive load, and temperature conditions at steady state until end of life.)  | M           | Vo          | 1.45        | —                  | 1.55                         | Vdc                            |
| Output Regulation:<br>Line (VI = VI, min to VI, max)<br>Load (IO = IO, min to IO, max)<br>Temperature (TA = TA, min to TA, max)  | M           | —<br>—<br>— | —<br>—<br>— | 0.05<br>0.05<br>15 | 0.2<br>0.2<br>50             | %, VO, set<br>%, VO, set<br>mV |
| Output Ripple and Noise<br>RMS (5 Hz to 20 MHz bandwidth)<br>Peak-to-peak (5 Hz to 20 MHz bandwidth)   | M           |             | —<br>—      | —<br>—             | 20<br>100                    | mVrms<br>mVp-p                 |
| External Load Capacitance  |             |             |             | —                  | 25,000                       | µF                             |
| Output Current<br>(Vo = 90% of VO, nom.)   | M           | IO          | 0.0         | —                  | 40                           | Adc                            |
| Output Current-limit Inception<br>(VO = 90% of VO, set)  | M           | IO, lim     | —           | 47                 | —                            | Adc                            |
| Output Short-circuit Current (Average)VO = 0.25 V  | Latched off |             |             |                    |                              |                                |
| Efficiency<br>(VI = VIN, nom; IO = IO, max), TA = 25 °C  |             | η           | —           | 86.5               | —                            | %                              |
| Switching Frequency  | All         | fSW         | —           | 300                | —                            | kHz                            |
| Dynamic Response<br>(DIO/Dt = 1 A/10 µs, VI = 48 V, TA = 25 °C); tested with a 220 µF aluminium and a 1.0 µF ceramic capacitor across the load.):<br>Load Change from IO = 50% to 75% of IO, max:<br>Peak Deviation<br>Settling Time<br>(VO < 10% of peak deviation)<br>Load Change from IO = 50% to 25% of IO, max :<br>Peak Deviation<br>Settling Time<br>(VO < 10% of peak deviation) |             |             |             |                    | 120<br>200<br><br>120<br>200 | mV<br>µs<br><br>mV<br>µs       |

## Isolation Specifications

| Parameter             | Symbol | Min | Typ  | Max | Unit |
|-----------------------|--------|-----|------|-----|------|
| Isolation Capacitance | Ciso   | —   | 5600 | —   | PF   |
| Isolation Resistance  | Riso   | 10  | —    | —   | MΩ   |

## General Specifications

| Parameter  | Min | Typ       | Max | Unit    |
|--|-----|-----------|-----|---------|
| Calculated MTBF (IO = 80% of IO, max TA = 40 °C) |     | 1,548,000 |     | Hours   |
| Weight   | —   | 38(1.54)  | —   | g (oz.) |

## Feature Specifications

Unless otherwise indicated, specifications apply over all operating input voltage, resistive load, and temperature conditions. See Feature Descriptions for additional information.

| Parameter  | Symbol                                   | Min              | Typ              | Max                         | Unit                          |
|--|--|------------------|------------------|-----------------------------|-------------------------------|
| Remote On/Off Signal Interface*<br>(VI = 0 V to 75 V; open collector or equivalent compatible; signal referenced to VI(-) terminal; see Figure 52 and Feature Descriptions.):<br>Preferred Logic:<br>Logic Low—Module On<br>Logic High—Module Off<br>Optional Logic:<br>Logic Low—Module Off<br>Logic High—Module On<br>Logic Low:<br>At Ion/off = 1.0 mA<br>At Von/off = 0.0 V<br>Logic High:<br>At Ion/off = 0.0 $\mu$ A<br>Leakage Current<br>Turn-on Time; see Typical Start-up Curve (IO = IO max;<br>Vo within $\pm$ 1% of steady state) | Von/off<br>Ion/off<br>Von/off<br>Ion/off | 0<br>—<br>—<br>— | —<br>—<br>—<br>2 | 1.2<br>1.0<br>15<br>50<br>4 | V<br>mA<br>V<br>$\mu$ A<br>ms |
| Output Voltage Adjustment<br>(See Feature Descriptions):<br>Output Voltage Remote-sense Range<br>Output Voltage Set-point Adjustment Range (trim)  | —<br>—                                   | —<br>80          | —<br>—           | 10<br>110                   | %VO, rated<br>%VO, nom        |
| Output Overvoltage Protection  | VO, ovsd                                 | 1.69             | —                | 2.07                        | V                             |
| Overtemperature Protection (IO = IO, max)  | Tref1                                    | —                | 127              | —                           | $^{\circ}$ C                  |

\* A Minimum OFF Period of 1 sec is recommended.

## Characteristic Curves

The following figures provide typical characteristics curves for the QRW040A0M ( $V_O = 1.5\text{ V}$ ) module at room temperature ( $T_A = 25\text{ }^\circ\text{C}$ )

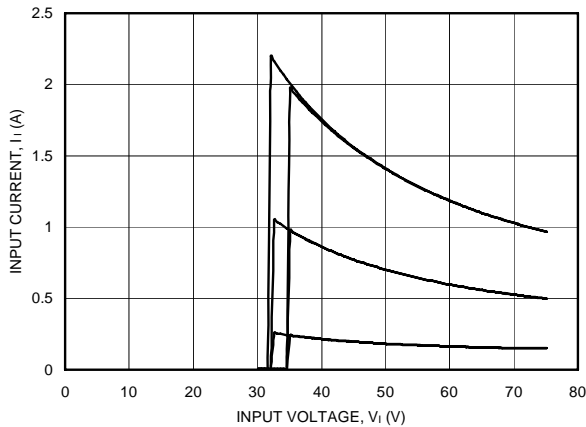

Figure 13. Input Voltage and Current Characteristics.

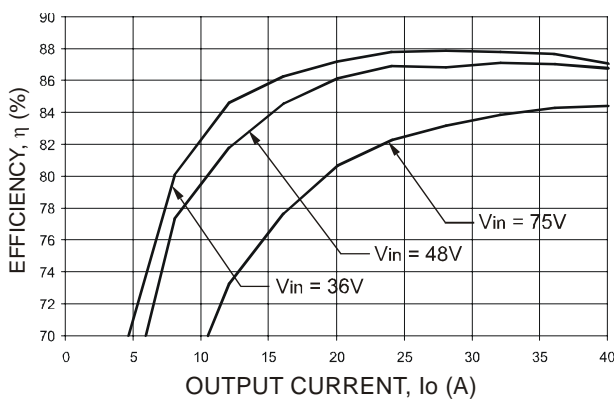

Figure 14. Converter Efficiency vs. Output Current.

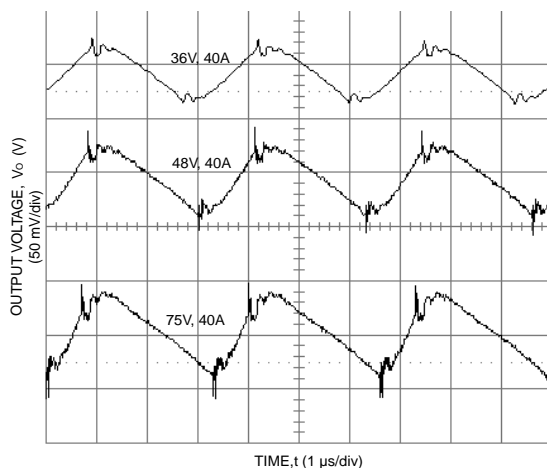
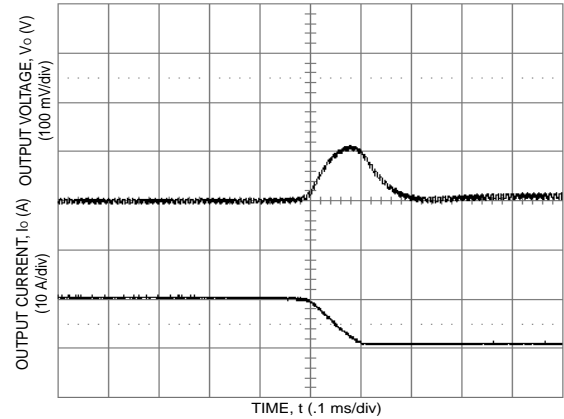

Figure 15. Output Ripple Voltage ( $I_O = I_{O, \text{max}}$ ).



Tested with a  $220\mu\text{F}$  aluminium and a  $1.0\mu\text{F}$  ceramic capacitor across the load.

Figure 16. Transient Response to Step Decrease in Load from 50% to 25% of Full Load ( $V_I = 48\text{ Vdc}$ ).

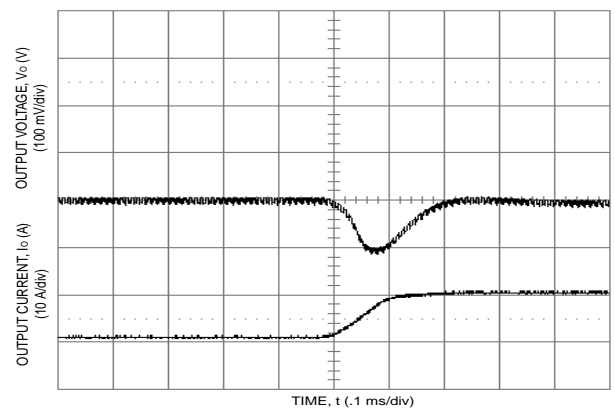
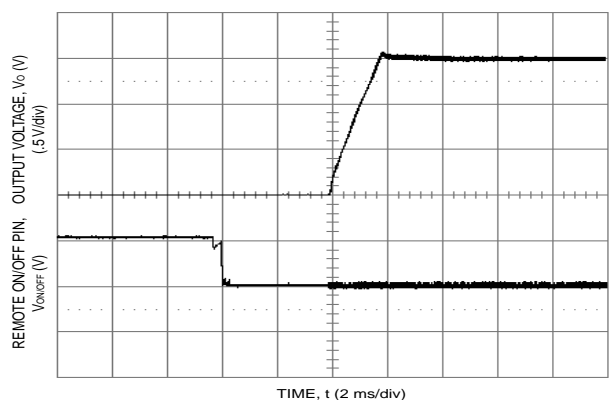

Figure 17. Transient Response to Step Increase in Load from 50% to 75% of Full Load ( $V_I = 48\text{ Vdc}$ ).



Tested with a  $10\mu\text{F}$  aluminium and a  $1.0\mu\text{F}$  tantalum capacitor across the load.

Figure 18. Start-up from Remote On/Off ( $I_O = I_{O, \text{max}}$ ).

## Electrical Specifications (continued)

### Output Specifications for the QRW040A0Y (Vo = 1.8Vdc)

| Parameter  | Device      | Symbol      | Min         | Typ                      | Max              | Unit                         |
|--|-------------|-------------|-------------|--------------------------|------------------|------------------------------|
| Output Voltage Set Point<br>(VI = 48 Vdc; IO = IO, min to IO, max, TA = 25 °C)   | Y           | Vo          | 1.77        | 1.8                      | 1.83             | Vdc                          |
| Output Voltage<br>(Over all operating input voltage, resistive load, and temperature conditions at steady state until end of life.)  | Y           | Vo          | 1.75        | —                        | 1.85             | Vdc                          |
| Output Regulation:<br>Line (VI = VI, min to VI, max)<br>Load (IO = IO, min to IO, max)<br>Temperature (TA = TA, min to TA, max)  | Y           | —<br>—<br>— | —<br>—<br>— | 0.05<br>0.05<br>15       | 0.2<br>0.2<br>50 | % VO, set<br>% VO, set<br>mV |
| Output Ripple and Noise<br>RMS (5 Hz to 20 MHz bandwidth)<br>Peak-to-peak (5 Hz to 20 MHz bandwidth)   | Y           |             | —<br>—      | —<br>—                   | 35<br>100        | mVrms<br>mVp-p               |
| External Load Capacitance  |             |             |             | —                        | 25,000           | µF                           |
| Output Current<br>(Vo = 90% of VO, nom.)   | Y           | IO          | 0.0         | —                        | 40               | Adc                          |
| Output Current-limit Inception<br>(VO = 90% of VO, set)  | Y           | IO, lim     | —           | 45                       | —                | Adc                          |
| Output Short-circuit Current (Average) VO = 0.25 V   | Latched off |             |             |                          |                  |                              |
| Efficiency<br>(VI = VIN, nom; IO = IO, max), TA = 25 °C  |             | η           | —           | 88                       | —                | %                            |
| Switching Frequency  | All         | fSW         | —           | 300                      | —                | kHz                          |
| Dynamic Response<br>(DIO/Dt = 1 A/10 µs, VI = 48 V, TA = 25 °C); tested with a 220 µF aluminium and a 1.0 µF ceramic capacitor across the load.):<br>Load Change from IO = 50% to 75% of IO, max:<br>Peak Deviation<br>Settling Time<br>(VO < 10% of peak deviation)<br>Load Change from IO = 50% to 25% of IO, max :<br>Peak Deviation<br>Settling Time<br>(VO < 10% of peak deviation) |             |             |             | 200<br>200<br>200<br>200 |                  | mV<br>µs<br>mV<br>µs         |

## Isolation Specifications

| Parameter             | Symbol | Min | Typ  | Max | Unit |
|-----------------------|--------|-----|------|-----|------|
| Isolation Capacitance | Ciso   | —   | 5600 | —   | PF   |
| Isolation Resistance  | Riso   | 10  | —    | —   | MΩ   |

## General Specifications

| Parameter  | Min | Typ      | Max | Unit    |
|--|-----|----------|-----|---------|
| Calculated MTBF (IO = 80% of IO, max TA = 40 °C) |     | TBD      |     | Hours   |
| Weight   | —   | 38(1.34) | —   | g (oz.) |

## Feature Specifications

Unless otherwise indicated, specifications apply over all operating input voltage, resistive load, and temperature conditions. See Feature Descriptions for additional information.

| Parameter   | Symbol                                   | Min              | Typ              | Max                    | Unit                          |
|---|--|------------------|------------------|------------------------|-------------------------------|
| Remote On/Off Signal Interface*<br>(VI = 0 V to 75 V; open collector or equivalent compatible; signal referenced to VI(-) terminal; see Figure 52 and Feature Descriptions.):<br>Preferred Logic:<br>Logic Low—Module On<br>Logic High—Module Off<br>Optional Logic:<br>Logic Low—Module Off<br>Logic High—Module On<br>Logic Low:<br>At Ion/off = 1.0 mA<br>At Von/off = 0.0 V<br>Logic High:<br>At Ion/off = 0.0 $\mu$ A<br>Leakage Current<br>Turn-on Time; see Typical Start-up Curve (IO = IO max; Vo within $\pm$ 1% of steady state) | Von/off<br>Ion/off<br>Von/off<br>Ion/off | 0<br>—<br>—<br>— | —<br>—<br>—<br>2 | 1.2<br>1.0<br>15<br>50 | V<br>mA<br>V<br>$\mu$ A<br>ms |
| Output Voltage Adjustment<br>(See Feature Descriptions):<br>Output Voltage Remote-sense Range<br>Output Voltage Set-point Adjustment Range (trim)   | —<br>—                                   | —<br>80          | —<br>—           | 10<br>110              | %VO, rated<br>%VO, nom        |
| Output Overvoltage Protection   | VO, ovsd                                 | 2.0              | —                | 2.5                    | V                             |
| Overtemperature Protection (IO = IO, max)   | Tref1                                    | —                | 127              | —                      | $^{\circ}$ C                  |

\* A Minimum OFF Period of 1 sec is recommended.

### Characteristic Curves

The following figures provide typical characteristics curves for the QRW040A0Y ( $V_O = 1.8\text{ V}$ ) module at room temperature ( $T_A = 25\text{ }^\circ\text{C}$ )

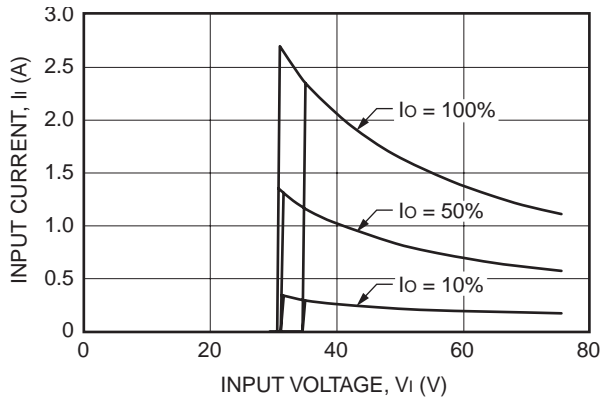

Figure 19. Input Voltage and Current Characteristics.

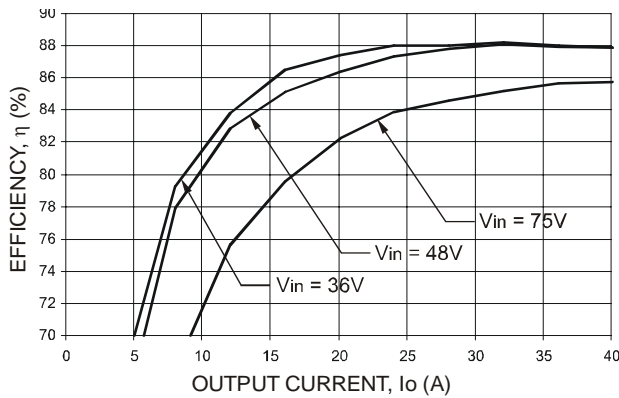

Figure 20. Converter Efficiency vs. Output Current.

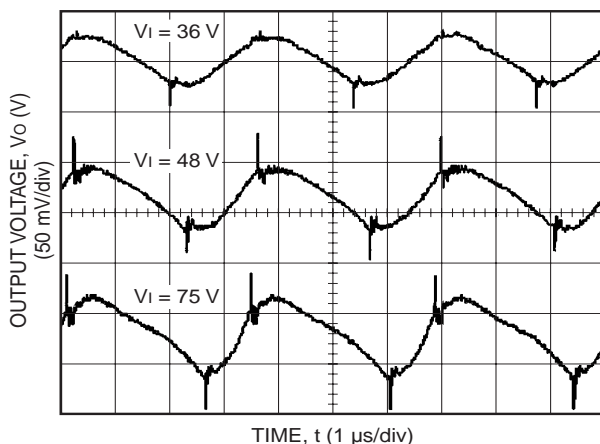
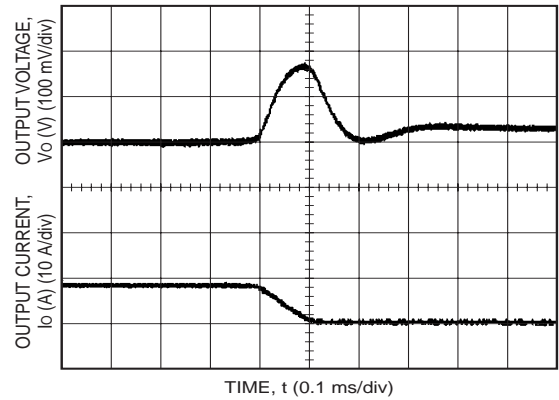

Figure 21. Output Ripple Voltage ( $I_O = I_{O, \text{max}}$ ).



Tested with a  $220\mu\text{F}$  aluminium and a  $1.0\mu\text{F}$  ceramic capacitor across the load.

Figure 22. Transient Response to Step Decrease in Load from 50% to 25% of Full Load ( $V_I = 48\text{ Vdc}$ ).

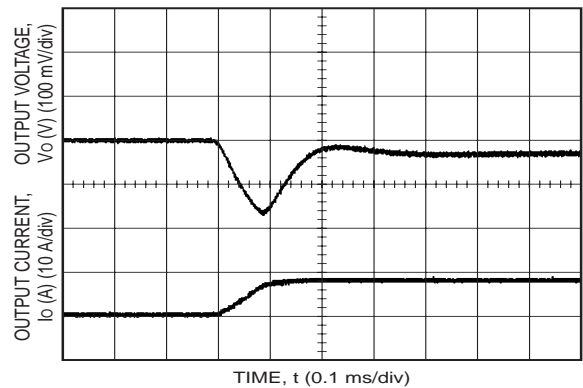
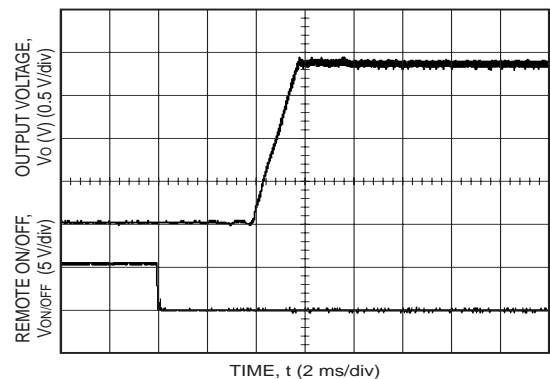

Figure 23. Transient Response to Step Increase in Load from 50% to 75% of Full Load ( $V_I = 48\text{ Vdc}$ ).



Tested with a  $10\mu\text{F}$  aluminium and a  $1.0\mu\text{F}$  tantalum capacitor across the load.

Figure 24. Start-up from Remote On/Off ( $I_O = I_{O, \text{max}}$ ).

## Electrical Specifications (continued)

### Output Specifications for the QRW035A0G (Vo = 2.5Vdc)

| Parameter  | Device      | Symbol      | Min         | Typ                          | Max              | Unit                           |
|--|-------------|-------------|-------------|------------------------------|------------------|--------------------------------|
| Output Voltage Set Point<br>(VI = 48 Vdc; IO = IO, min to IO, max, TA = 25 °C)   | G           | Vo          | 2.47        | 2.5                          | 2.53             | Vdc                            |
| Output Voltage<br>(Over all operating input voltage, resistive load, and temperature conditions at steady state until end of life.)  | G           | Vo          | 2.42        | —                            | 2.58             | Vdc                            |
| Output Regulation:<br>Line (VI = VI, min to VI, max)<br>Load (IO = IO, min to IO, max)<br>Temperature (TA = TA, min to TA, max)  | G           | —<br>—<br>— | —<br>—<br>— | 0.05<br>0.05<br>15           | 0.2<br>0.2<br>50 | %, VO, set<br>%, VO, set<br>mV |
| Output Ripple and Noise<br>RMS (5 Hz to 20 MHz bandwidth)<br>Peak-to-peak (5 Hz to 20 MHz bandwidth)   | G           |             | —<br>—      | —<br>—                       | 35<br>100        | mVrms<br>mVp-p                 |
| External Load Capacitance  |             |             |             | —                            | 25,000           | µF                             |
| Output Current<br>(Vo = 90% of VO, nom.)   | G           | IO          | 0.0         | —                            | 35               | Adc                            |
| Output Current-limit Inception<br>(VO = 90% of VO, set)  | G           | IO, lim     | —           | 39                           | —                | Adc                            |
| Output Short-circuit Current (Average) VO = 0.25 V   | Latched off |             |             |                              |                  |                                |
| Efficiency<br>(VI = VIN, nom; IO = IO, max), TA = 25 °C  |             | η           | —           | 90                           | —                | %                              |
| Switching Frequency  | All         | fSW         | —           | 300                          | —                | kHz                            |
| Dynamic Response<br>(DIO/Dt = 1 A/10 µs, VI = 48 V, TA = 25 °C); tested with a 220 µF aluminium and a 1.0 µF ceramic capacitor across the load.):<br>Load Change from IO = 50% to 75% of IO, max:<br>Peak Deviation<br>Settling Time (VO < 10% of peak deviation)<br>Load Change from IO = 50% to 25% of IO, max :<br>Peak Deviation<br>Settling Time (VO < 10% of peak deviation) |             |             |             | 150<br>200<br><br>150<br>200 |                  | mV<br>µs<br><br>mV<br>µs       |

## Isolation Specifications

| Parameter             | Symbol | Min | Typ  | Max | Unit |
|-----------------------|--------|-----|------|-----|------|
| Isolation Capacitance | Ciso   | —   | 5600 | —   | PF   |
| Isolation Resistance  | Riso   | 10  | —    | —   | MΩ   |

## General Specifications

| Parameter  | Min | Typ      | Max | Unit    |
|--|-----|----------|-----|---------|
| Calculated MTBF (IO = 80% of IO, max TA = 40 °C) | TBD |          |     | Hours   |
| Weight   | —   | 38(1.34) | —   | g (oz.) |

## Feature Specifications

Unless otherwise indicated, specifications apply over all operating input voltage, resistive load, and temperature conditions. See Feature Descriptions for additional information.

| Parameter   | Symbol                                   | Min              | Typ              | Max                         | Unit                     |
|---|--|------------------|------------------|-----------------------------|--------------------------|
| Remote On/Off Signal Interface*<br>(VI = 0 V to 75 V; open collector or equivalent compatible; signal referenced to VI(-) terminal; see Figure 52 and Feature Descriptions.):<br>Preferred Logic:<br>Logic Low—Module On<br>Logic High—Module Off<br>Optional Logic:<br>Logic Low—Module Off<br>Logic High—Module On<br>Logic Low:<br>At Ion/off = 1.0 mA<br>At Von/off = 0.0 V<br>Logic High:<br>At Ion/off = 0.0 μA<br>Leakage Current<br>Turn-on Time; see Typical Start-up Curve (IO = IO max; Vo within ±1% of steady state) | Von/off<br>Ion/off<br>Von/off<br>Ion/off | 0<br>—<br>—<br>— | —<br>—<br>—<br>2 | 1.2<br>1.0<br>15<br>50<br>4 | V<br>mA<br>V<br>μA<br>ms |
| Output Voltage Adjustment<br>(See Feature Descriptions):<br>Output Voltage Remote-sense Range<br>Output Voltage Set-point Adjustment Range (trim)   | —<br>—                                   | —<br>80          | —<br>—           | 10<br>110                   | %VO, rated<br>%VO, nom   |
| Output Overvoltage Protection   | VO, ovsd                                 | 2.9              | —                | 3.2                         | V                        |
| Overtemperature Protection (IO = IO, max)   | Tref1                                    | —                | 127              | —                           | °C                       |

\* A Minimum OFF Period of 1 sec is recommended.



## Characteristic Curves

The following figures provide typical characteristics curves for the QRW035A0G ( $V_O = 2.5\text{ V}$ ) module at room temperature ( $T_A = 25\text{ }^\circ\text{C}$ )

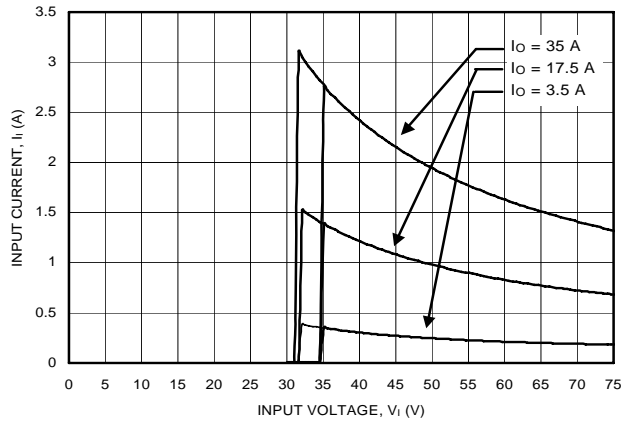

Figure 25. Input Voltage and Current Characteristics.

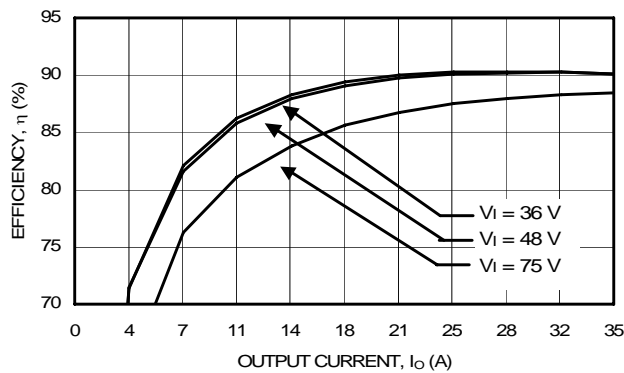

Figure 26. Converter Efficiency vs. Output Current.

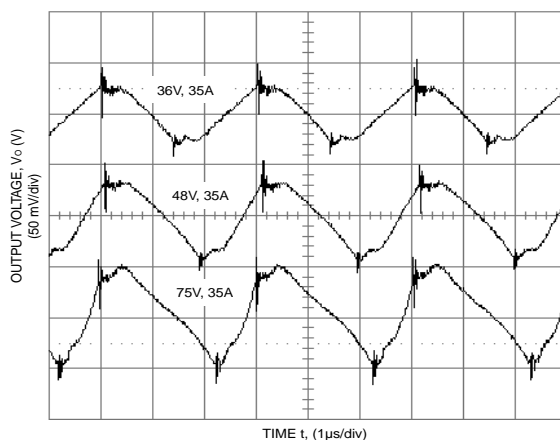
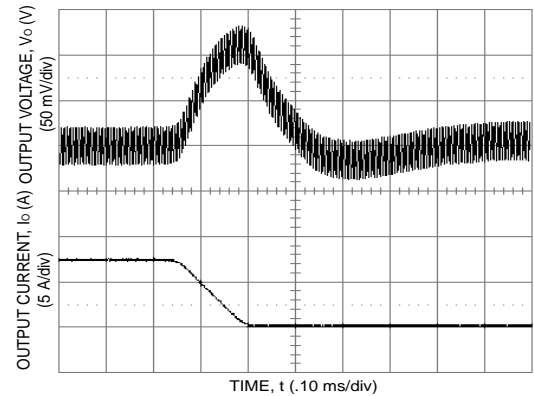

Figure 27. Output Ripple Voltage ( $I_O = I_{O, \text{max}}$ ).



Tested with a  $220\mu\text{F}$  aluminium and a  $1.0\mu\text{F}$  ceramic capacitor across the load.

Figure 28. Transient Response to Step Decrease in Load from 50% to 25% of Full Load ( $V_I = 48\text{ Vdc}$ ).

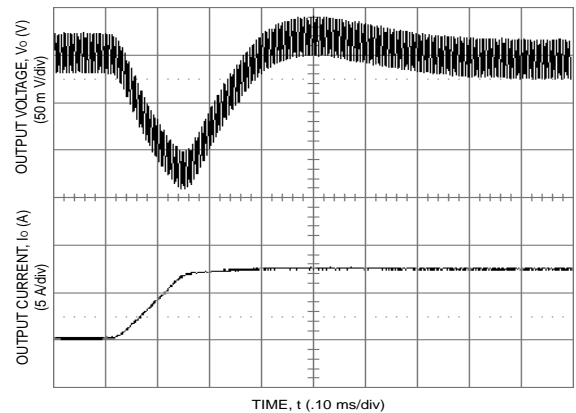
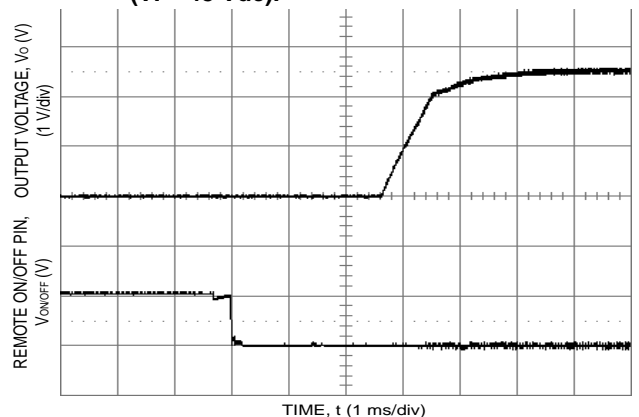

Figure 29. Transient Response to Step Increase in Load from 50% to 75% of Full Load ( $V_I = 48\text{ Vdc}$ ).



Tested with a  $10\mu\text{F}$  aluminium and a  $1.0\mu\text{F}$  tantalum capacitor across the load.

Figure 30. Start-up from Remote On/Off ( $I_O = I_{O, \text{max}}$ ).

## Electrical Specifications (continued)

### Output Specifications for the QRW035A0F (Vo = 3.3Vdc)

| Parameter  | Device      | Symbol      | Min         | Typ                | Max                          | Unit                           |
|--|-------------|-------------|-------------|--------------------|------------------------------|--------------------------------|
| Output Voltage Set Point<br>(VI = 48 Vdc; IO = IO, min to IO, max, TA = 25 °C)   | F           | Vo          | 3.24        | 3.3                | 3.36                         | Vdc                            |
| Output Voltage<br>(Over all operating input voltage, resistive load, and temperature conditions at steady state until end of life.)  | F           | Vo          | 3.2         | —                  | 3.4                          | Vdc                            |
| Output Regulation:<br>Line (VI = VI, min to VI, max)<br>Load (IO = IO, min to IO, max)<br>Temperature (TA = TA, min to TA, max)  | F           | —<br>—<br>— | —<br>—<br>— | 0.05<br>0.05<br>15 | 0.2<br>0.2<br>50             | %, VO, set<br>%, VO, set<br>mV |
| Output Ripple and Noise<br>RMS (5 Hz to 20 MHz bandwidth)<br>Peak-to-peak (5 Hz to 20 MHz bandwidth)   | F           |             | —<br>—      | —<br>—             | 30<br>100                    | mVrms<br>mVp-p                 |
| External Load Capacitance  |             |             |             | —                  | 30,000                       | µF                             |
| Output Current<br>(Vo = 90% of VO, nom.)   | F           | IO          | 0.0         | —                  | 35                           | Adc                            |
| Output Current-limit Inception<br>(VO = 90% of VO, set)  | F           | IO, lim     | —           | 39                 | —                            | Adc                            |
| Output Short-circuit Current (Average) VO = 0.25 V   | Latched off |             |             |                    |                              |                                |
| Efficiency<br>(VI = VIN, nom; IO = IO, max), TA = 25 °C  |             | η           | —           | 91                 | —                            | %                              |
| Switching Frequency  | All         | fSW         | —           | 300                | —                            | kHz                            |
| Dynamic Response<br>(DIO/Dt = 1 A/10 µs, VI = 48 V, TA = 25 °C); tested with a 220 µF aluminium and a 1.0 µF ceramic capacitor across the load.):<br>Load Change from IO = 50% to 75% of IO, max:<br>Peak Deviation<br>Settling Time<br>(VO < 10% of peak deviation)<br>Load Change from IO = 50% to 25% of IO, max :<br>Peak Deviation<br>Settling Time<br>(VO < 10% of peak deviation) |             |             |             |                    | 160<br>300<br><br>160<br>300 | mV<br>µs<br><br>mV<br>µs       |

## Isolation Specifications

| Parameter             | Symbol | Min | Typ  | Max | Unit |
|-----------------------|--------|-----|------|-----|------|
| Isolation Capacitance | Ciso   | —   | 5600 | —   | PF   |
| Isolation Resistance  | Riso   | 10  | —    | —   | MΩ   |

## General Specifications

| Parameter  | Min | Typ       | Max | Unit    |
|--|-----|-----------|-----|---------|
| Calculated MTBF (IO = 80% of IO, max TA = 40 °C) |     | 1,700,000 |     | Hours   |
| Weight   | —   | 37(1.31)  | —   | g (oz.) |

## Feature Specifications

Unless otherwise indicated, specifications apply over all operating input voltage, resistive load, and temperature conditions. See Feature Descriptions for additional information.

| Parameter  | Symbol                                   | Min              | Typ              | Max                         | Unit                          |
|--|--|------------------|------------------|-----------------------------|-------------------------------|
| Remote On/Off Signal Interface*<br>(VI = 0 V to 75 V; open collector or equivalent compatible; signal referenced to VI(-) terminal; see Figure 52 and Feature Descriptions.):<br>Preferred Logic:<br>Logic Low—Module On<br>Logic High—Module Off<br>Optional Logic:<br>Logic Low—Module Off<br>Logic High—Module On<br>Logic Low:<br>At Ion/off = 1.0 mA<br>At Von/off = 0.0 V<br>Logic High:<br>At Ion/off = 0.0 $\mu$ A<br>Leakage Current<br>Turn-on Time; see Typical Start-up Curve (IO = IO max;<br>Vo within $\pm$ 1% of steady state) | Von/off<br>Ion/off<br>Von/off<br>Ion/off | 0<br>—<br>—<br>— | —<br>—<br>—<br>2 | 1.2<br>1.0<br>15<br>50<br>4 | V<br>mA<br>V<br>$\mu$ A<br>ms |
| Output Voltage Adjustment<br>(See Feature Descriptions):<br>Output Voltage Remote-sense Range<br>Output Voltage Set-point Adjustment Range (trim)  | —<br>—                                   | —<br>80          | —<br>—           | 0.5<br>110                  | V<br>%V0,nom                  |
| Output Overvoltage Protection  | VO, ovsd                                 | 3.8              | —                | 4.6                         | V                             |
| Overtemperature Protection (IO = IO, max)  | Tref1                                    | —                | 127              | —                           | $^{\circ}$ C                  |

\* A Minimum OFF Period of 1 sec is recommended.

## Characteristic Curves

The following figures provide typical characteristics curves for the QRW035A0F ( $V_O = 3.3\text{ V}$ ) module at room temperature ( $T_A = 25\text{ }^\circ\text{C}$ )

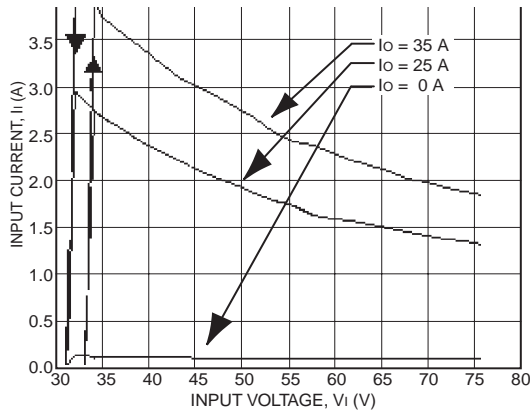

Figure 31. Input Voltage and Current Characteristics.

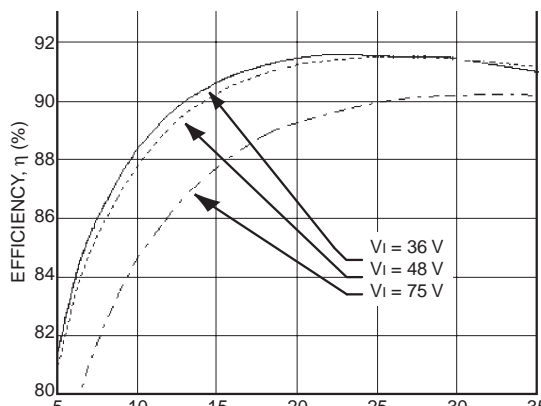

Figure 32. Converter Efficiency vs. Output Current.

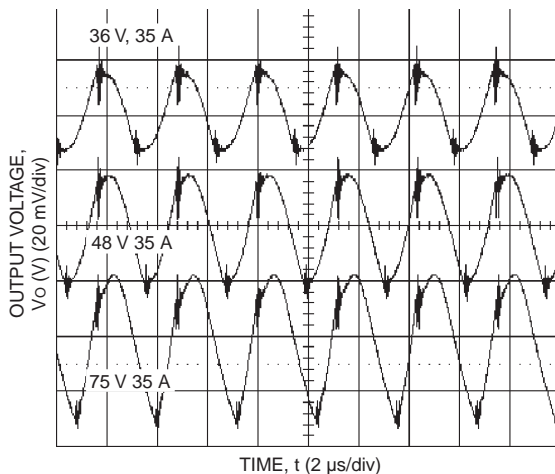
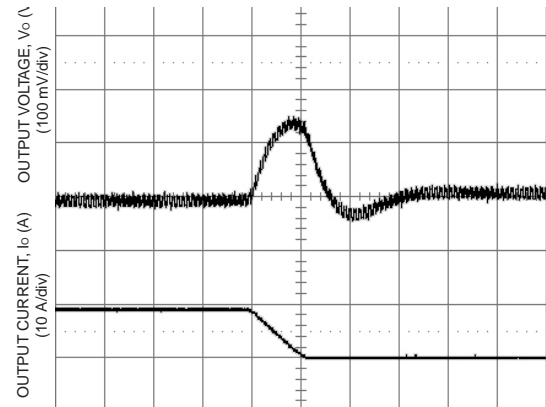

Figure 33. Output Ripple Voltage ( $I_O = I_{O, \text{max}}$ ).

Lineage Power



Tested with a  $220\mu\text{F}$  aluminium and a  $1.0\mu\text{F}$  ceramic capacitor across the load.

Figure 34. Transient Response to Step Decrease in Load from 50% to 25% of Full Load ( $V_I = 48\text{ Vdc}$ ).

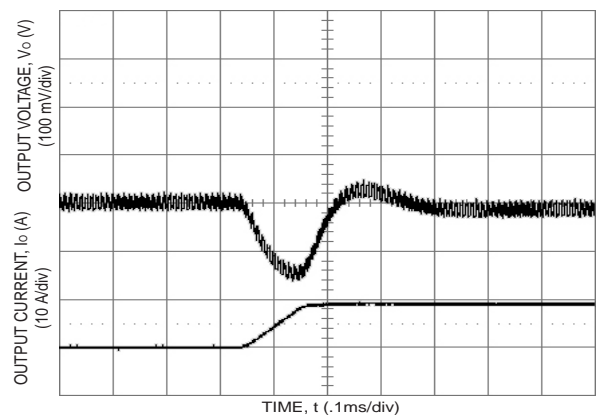
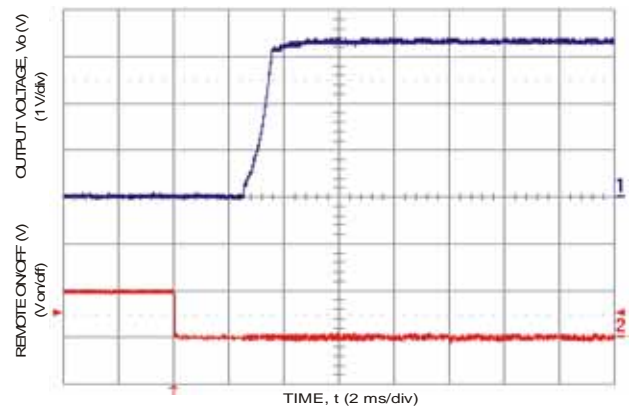

Figure 35. Transient Response to Step Increase in Load from 50% to 75% of Full Load ( $V_I = 48\text{ Vdc}$ ).



Tested with a  $10\mu\text{F}$  aluminium and a  $1.0\mu\text{F}$  tantalum capacitor across the load.

Figure 36. Start-up from Remote On/Off ( $I_O = I_{O, \text{max}}$ ).

## Electrical Specifications (continued)

### Output Specifications for the QRW025A0A (Vo = 5.0 Vdc)

| Parameter  | Device      | Symbol      | Min         | Typ                          | Max              | Unit                         |
|--|-------------|-------------|-------------|------------------------------|------------------|------------------------------|
| Output Voltage Set Point<br>(VI = 48 Vdc; IO = IO, min to IO, max, TA = 25 °C)   | A           | Vo          | 4.95        | 5.0                          | 5.05             | Vdc                          |
| Output Voltage<br>(Over all operating input voltage, resistive load, and temperature conditions at steady state until end of life.)  | A           | Vo          | 4.85        | —                            | 5.15             | Vdc                          |
| Output Regulation:<br>Line (VI = VI, min to VI, max)<br>Load (IO = IO, min to IO, max)<br>Temperature (TA = TA, min to TA, max)  | A           | —<br>—<br>— | —<br>—<br>— | 0.05<br>0.05<br>15           | 0.2<br>0.2<br>50 | % VO, set<br>% VO, set<br>mV |
| Output Ripple and Noise<br>RMS (5 Hz to 20 MHz bandwidth)<br>Peak-to-peak (5 Hz to 20 MHz bandwidth)   | A           |             | —<br>—      | —<br>—                       | 30<br>100        | mVrms<br>mVp-p               |
| External Load Capacitance  |             |             |             | —                            | 10,000           | µF                           |
| Output Current<br>(Vo = 90% of VO, nom.)   | A           | IO          | 0.0         | —                            | 25               | Adc                          |
| Output Current-limit Inception<br>(VO = 90% of VO, set)  | A           | IO, lim     | —           | 30                           | —                | Adc                          |
| Output Short-circuit Current (Average) VO = 0.25 V   | Latched off |             |             |                              |                  |                              |
| Efficiency<br>(VI = VIN, nom; IO = IO, max), TA = 25 °C  |             | η           | —           | 91.5                         | —                | %                            |
| Switching Frequency  | All         | fSW         | —           | 300                          | —                | kHz                          |
| Dynamic Response<br>(DIO/Dt = 1 A/10 µs, VI = 48 V, TA = 25 °C); tested with a 220 µF aluminium and a 1.0 µF ceramic capacitor across the load.):<br>Load Change from IO = 50% to 75% of IO, max:<br>Peak Deviation<br>Settling Time<br>(VO < 10% of peak deviation)<br>Load Change from IO = 50% to 25% of IO, max :<br>Peak Deviation<br>Settling Time<br>(VO < 10% of peak deviation) |             |             |             | 250<br>200<br><br>250<br>200 |                  | mV<br>µs<br><br>mV<br>µs     |

## Isolation Specifications

| Parameter             | Symbol | Min | Typ  | Max | Unit |
|-----------------------|--------|-----|------|-----|------|
| Isolation Capacitance | Ciso   | —   | 5600 | —   | PF   |
| Isolation Resistance  | Riso   | 10  | —    | —   | MΩ   |

## General Specifications

| Parameter  | Min | Typ      | Max | Unit    |
|--|-----|----------|-----|---------|
| Calculated MTBF (IO = 80% of IO, max TA = 40 °C) |     | TBD      |     | Hours   |
| Weight   | —   | 37(1.31) | —   | g (oz.) |

## Feature Specifications

Unless otherwise indicated, specifications apply over all operating input voltage, resistive load, and temperature conditions. See Feature Descriptions for additional information.

| Parameter  | Symbol                                   | Min              | Typ              | Max                         | Unit                          |
|--|--|------------------|------------------|-----------------------------|-------------------------------|
| Remote On/Off Signal Interface*<br>(VI = 0 V to 75 V; open collector or equivalent compatible; signal referenced to VI(-) terminal; see Figure 52 and Feature Descriptions.):<br>Preferred Logic:<br>Logic Low—Module On<br>Logic High—Module Off<br>Optional Logic:<br>Logic Low—Module Off<br>Logic High—Module On<br>Logic Low:<br>At Ion/off = 1.0 mA<br>At Von/off = 0.0 V<br>Logic High:<br>At Ion/off = 0.0 $\mu$ A<br>Leakage Current<br>Turn-on Time; see Typical Start-up Curve (IO = IO max;<br>Vo within $\pm$ 1% of steady state) | Von/off<br>Ion/off<br>Von/off<br>Ion/off | 0<br>—<br>—<br>— | —<br>—<br>—<br>1 | 1.2<br>1.0<br>15<br>50<br>4 | V<br>mA<br>V<br>$\mu$ A<br>ms |
| Output Voltage Adjustment<br>(See Feature Descriptions):<br>Output Voltage Remote-sense Range<br>Output Voltage Set-point Adjustment Range (trim)  | —<br>—                                   | —<br>80          | —<br>—           | 0.5<br>110                  | V<br>%V0,nom                  |
| Output Overvoltage Protection  | VO, ovsd                                 | 5.6              | —                | 6.8                         | V                             |
| Overtemperature Protection (IO = IO, max)  | Tref1                                    | —                | 127              | —                           | $^{\circ}$ C                  |

\* A Minimum OFF Period of 1 sec is recommended.

### Characteristic Curves

The following figures provide typical characteristics curves for the QRW025A0A ( $V_O = 5.0V$ ) module at room temperature ( $T_A = 25^\circ C$ )

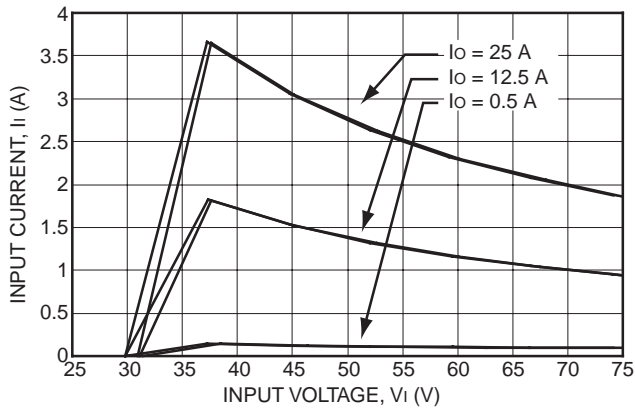

Figure 37. Input Voltage and Current Characteristics.

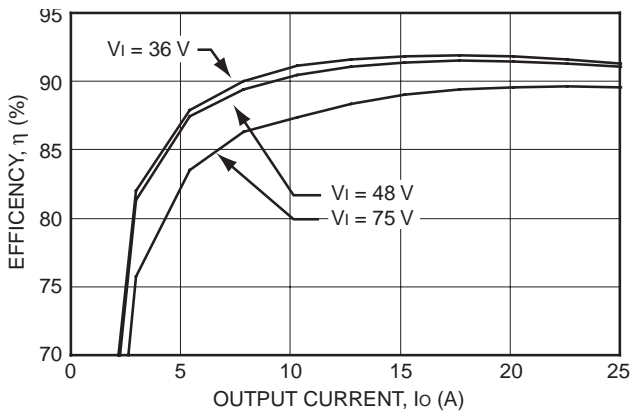

Figure 38. Converter Efficiency vs. Output Current.

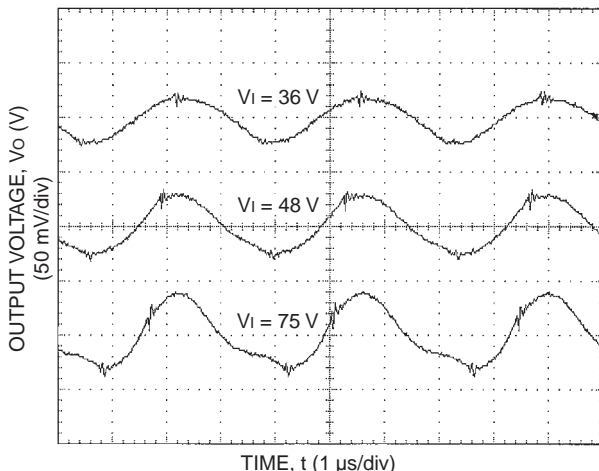
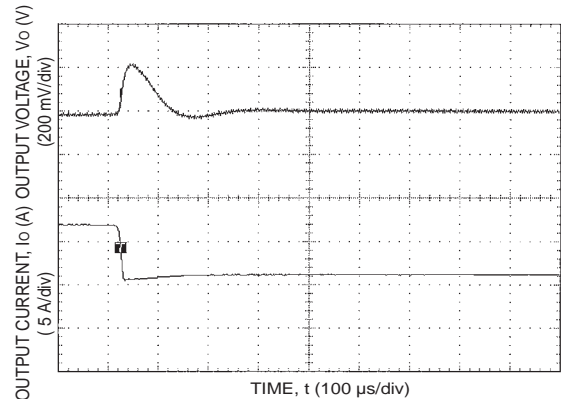

Figure 39. Output Ripple Voltage ( $I_O = I_{O, max}$ ).



Tested with a  $220\mu F$  aluminium and a  $1.0\mu F$  ceramic capacitor across the load.

Figure 40. Transient Response to Step Decrease in Load from 50% to 25% of Full Load ( $V_I = 48 V_{dc}$ ).

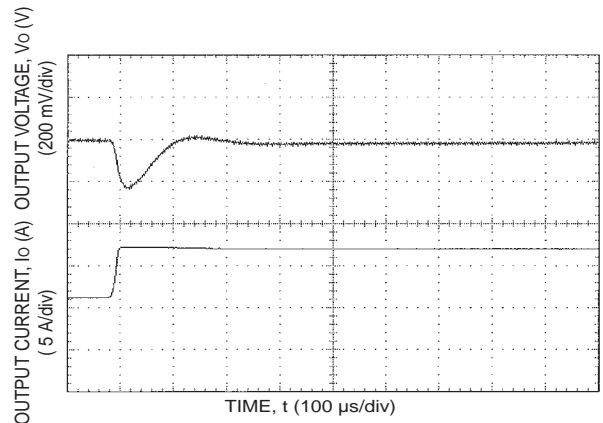
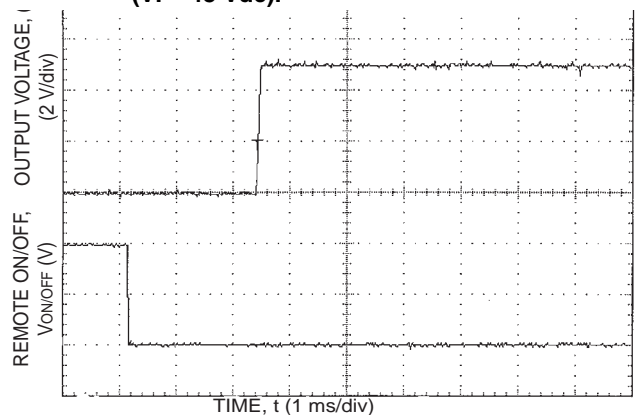

Figure 41. Transient Response to Step Increase in Load from 50% to 75% of Full Load ( $V_I = 48 V_{dc}$ ).



Tested with a  $10\mu F$  aluminium and a  $1.0\mu F$  tantalum capacitor across the load.

Figure 42. Start-up from Remote On/Off ( $I_O = I_{O, max}$ ).

## Electrical Specifications (continued)

### Output Specifications for the QRW010A0B (Vo = 12.0 Vdc)

| Parameter  | Device      | Symbol      | Min         | Typ                          | Max              | Unit                         |
|--|-------------|-------------|-------------|------------------------------|------------------|------------------------------|
| Output Voltage Set Point<br>(VI = 48 Vdc; IO = IO, min to IO, max, TA = 25 °C)   | B           | Vo          | 11.76       | 12                           | 12.24            | Vdc                          |
| Output Voltage<br>(Over all operating input voltage, resistive load, and temperature conditions at steady state until end of life.)  | B           | Vo          | 11.64       | —                            | 12.36            | Vdc                          |
| Output Regulation:<br>Line (VI = VI, min to VI, max)<br>Load (IO = IO, min to IO, max)<br>Temperature (TA = TA, min to TA, max)  | B           | —<br>—<br>— | —<br>—<br>— | 0.05<br>0.05<br>15           | 0.2<br>0.2<br>50 | % VO, set<br>% VO, set<br>mV |
| Output Ripple and Noise<br>RMS (5 Hz to 20 MHz bandwidth)<br>Peak-to-peak (5 Hz to 20 MHz bandwidth)   | B           |             | —<br>—      | —<br>—                       | 30<br>100        | mVrms<br>mVp-p               |
| External Load Capacitance  |             |             |             | —                            | 2200             | µF                           |
| Output Current<br>(Vo = 90% of VO, nom.)   | B           | IO          | 0.0         | —                            | 10               | Adc                          |
| Output Current-limit Inception<br>(VO = 90% of VO, set)  | B           | IO, lim     | —           | 12                           | —                | Adc                          |
| Output Short-circuit Current (Average) VO = 0.25 V   | Latched off |             |             |                              |                  |                              |
| Efficiency<br>(VI = VIN, nom; IO = IO, max), TA = 25 °C  |             | η           | —           | 92.5                         | —                | %                            |
| Switching Frequency  | All         | fSW         | —           | 300                          | —                | kHz                          |
| Dynamic Response<br>(DIO/Dt = 1 A/10 µs, VI = 48 V, TA = 25 °C); tested with a 220 µF aluminium and a 1.0 µF ceramic capacitor across the load.):<br>Load Change from IO = 50% to 75% of IO, max:<br>Peak Deviation<br>Settling Time<br>(VO < 10% of peak deviation)<br>Load Change from IO = 50% to 25% of IO, max :<br>Peak Deviation<br>Settling Time<br>(VO < 10% of peak deviation) |             |             |             | 360<br>300<br><br>360<br>300 |                  | mV<br>µs<br><br>mV<br>µs     |

## Isolation Specifications

| Parameter             | Symbol | Min | Typ  | Max | Unit |
|-----------------------|--------|-----|------|-----|------|
| Isolation Capacitance | Ciso   | —   | 5600 | —   | PF   |
| Isolation Resistance  | Riso   | 10  | —    | —   | MΩ   |

## General Specifications

| Parameter  | Min | Typ       | Max | Unit    |
|--|-----|-----------|-----|---------|
| Calculated MTBF (IO = 80% of IO, max TA = 40 °C) |     | 1,227,000 |     | Hours   |
| Weight   | —   | 37(1.31)  | —   | g (oz.) |



## Feature Specifications

Unless otherwise indicated, specifications apply over all operating input voltage, resistive load, and temperature conditions. See Feature Descriptions for additional information.

| Parameter   | Symbol                                   | Min              | Typ              | Max                         | Unit                          |
|---|--|------------------|------------------|-----------------------------|-------------------------------|
| Remote On/Off Signal Interface*<br>(VI = 0 V to 75 V; open collector or equivalent compatible; signal referenced to VI(-) terminal; see Figure 52 and Feature Descriptions.):<br>Preferred Logic:<br>Logic Low—Module On<br>Logic High—Module Off<br>Optional Logic:<br>Logic Low—Module Off<br>Logic High—Module On<br>Logic Low:<br>At Ion/off = 1.0 mA<br>At Von/off = 0.0 V<br>Logic High:<br>At Ion/off = 0.0 $\mu$ A<br>Leakage Current<br>Turn-on Time; see Typical Start-up Curve (IO = IO max; Vo within $\pm$ 1% of steady state) | Von/off<br>Ion/off<br>Von/off<br>Ion/off | 0<br>—<br>—<br>— | —<br>—<br>—<br>2 | 1.2<br>1.0<br>15<br>50<br>4 | V<br>mA<br>V<br>$\mu$ A<br>ms |
| Output Voltage Adjustment<br>(See Feature Descriptions):<br>Output Voltage Remote-sense Range<br>Output Voltage Set-point Adjustment Range (trim)   | —<br>—                                   | —<br>80          | —<br>—           | 0.5<br>110                  | V<br>%VO,nom                  |
| Output Overvoltage Protection   | VO, ovsd                                 | 13.5             | 15               | 16.5                        | V                             |
| Overtemperature Protection (IO = IO, max)   | Tref1                                    | —                | 127              | —                           | $^{\circ}$ C                  |

\* A Minimum OFF Period of 1 sec is recommended.

### Characteristic Curves

The following figures provide typical characteristics curves for the QRW010A0B ( $V_O = 12.0V$ ) module at room temperature ( $T_A = 25^\circ C$ )

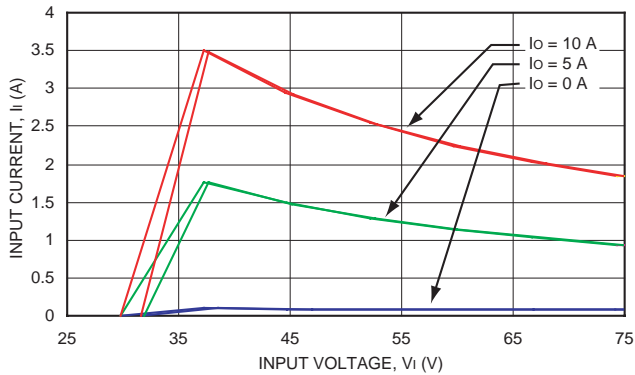

Figure 43. Input Voltage and Current Characteristics.

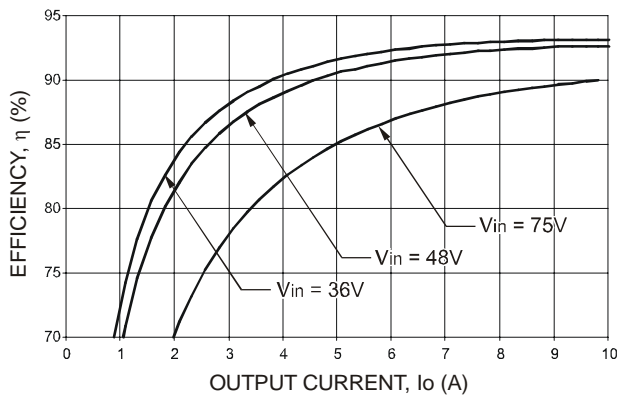

Figure 44. Converter Efficiency vs. Output Current.

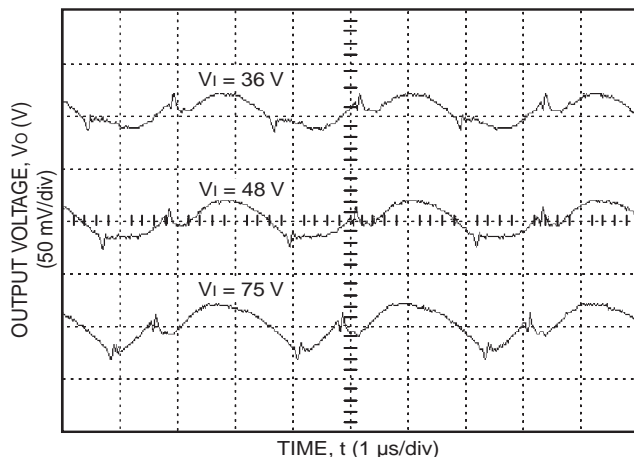
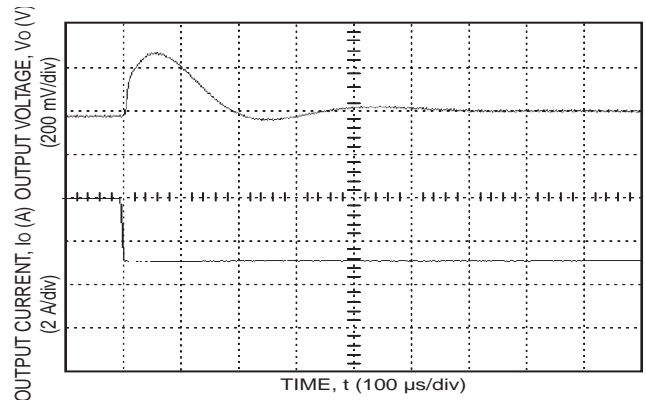

Figure 45. Output Ripple Voltage ( $I_O = I_{O, max}$ ).



Tested with a 220 $\mu F$  aluminium and a 1.0 $\mu F$  ceramic capacitor across the load.

Figure 46. Transient Response to Step Decrease in Load from 50% to 25% of Full Load ( $V_I = 48 V_{dc}$ ).

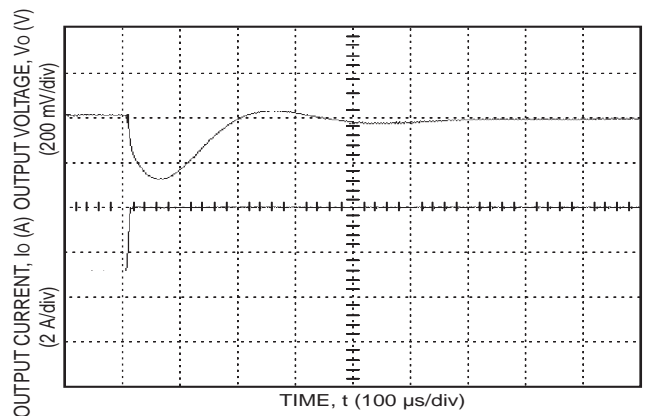
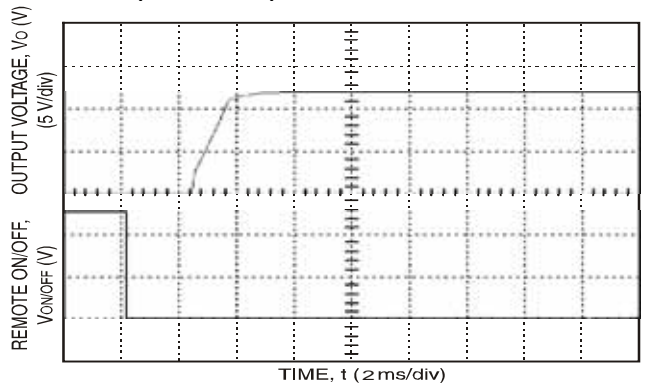

Figure 47. Transient Response to Step Increase in Load from 50% to 75% of Full Load ( $V_I = 48 V_{dc}$ ).



Tested with a 10 $\mu F$  aluminium and a 1.0 $\mu F$  tantalum capacitor across the load.

Figure 48. Start-up from Remote On/Off ( $I_O = I_{O, max}$ ).

## Test Configurations

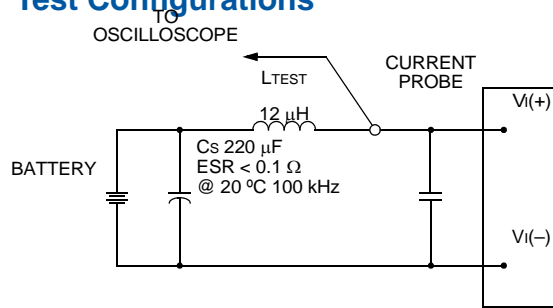

Note: Measure input reflected-ripple current with a simulated source inductance (LTEST) of 12 µH. Capacitor CS offsets possible battery impedance. Measure current as shown above.

**Figure 49. Input Reflected-Ripple Test Setup.**

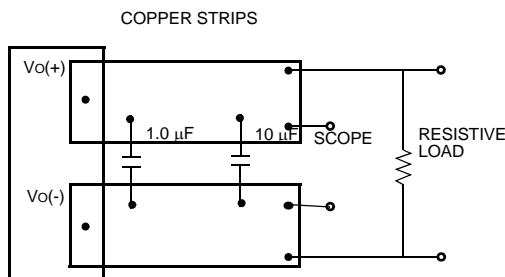

Note: Use a 1.0 µF ceramic capacitor and a 10 µF aluminum or tantalum capacitor. Scope measurement should be made using a BNC socket. Position the load between 51 mm and 76 mm (2 in. and 3 in.) from the module.

**Figure 50. Peak-to-Peak Output Noise Measurement Test Setup.**

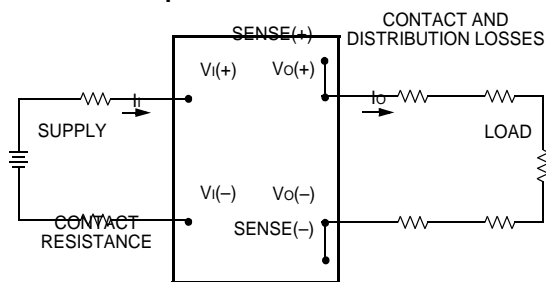

Note: All measurements are taken at the module terminals. When socketing, place Kelvin connections at module terminals to avoid measurement errors due to socket contact resistance.

$$\eta = \left( \frac{[V_{O(+)} - V_{O(-)}]I_O}{[V_{I(+)} - V_{I(-)}]I_I} \right) \times 100 \%$$

**Figure 51. Output Voltage and Efficiency Measurement.**

Lineage Power

## Design Considerations

### Input Source Impedance

The power module should be connected to a low ac-impedance input source. Highly inductive source impedances can affect the stability of the power module. For the test configuration in 49, a 33 µF electrolytic capacitor (ESR < 0.7 W at 100 kHz) mounted close to the power module helps ensure stability of the unit. For other highly inductive source impedances, consult the factory for further application guidelines.

### Output Capacitance

High output current transient rate of change (high di/dt) loads may require high values of output capacitance to supply the instantaneous energy requirement to the load. To minimize the output voltage transient drop during this transient, low E.S.R. (equivalent series resistance) capacitors may be required, since a high E.S.R. will produce a correspondingly higher voltage drop during the current transient.

Output capacitance and load impedance interact with the power module's output voltage regulation control system and may produce an 'unstable' output condition for the required values of capacitance and E.S.R.. Minimum and maximum values of output capacitance and of the capacitor's associated E.S.R. may be dictated, depending on the module's control system.

The process of determining the acceptable values of capacitance and E.S.R. is complex and is load-dependant. Lineage provides Web-based tools to assist the power module end-user in appraising and adjusting the effect of various load conditions and output capacitances on specific power modules for various load conditions.

## Safety Considerations

For safety-agency approval of the system in which the power module is used, the power module must be installed in compliance with the spacing and separation requirements of the end-use safety agency standard, i.e., UL60950, CSA C22.2 No. 60950-00, and VDE 0805:2001-12 (IEC60950, 3rd Ed).

These converters have been evaluated to the spacing requirements for Basic Insulation, per the above safety standards and 1500 Vdc is applied from VI to VO to 100% of outgoing production.

For end products connected to -48 Vdc, or -60 Vdc nominal DC MAINS (i.e. central office dc battery plant), no further fault testing is required.

Note: -60 V dc nominal battery plants are not available in the U.S. or Canada.

For all input voltages, other than DC MAINS, where the input voltage is less than 60 Vdc, if the input meets all of the requirements for SELV, then:

- The output may be considered SELV. Output voltages will remain within SELV limits even with internally-generated non-SELV voltages. Single component failure and fault tests were performed in the power converters.
- One pole of the input and one pole of the output are to be grounded, or both circuits are to be kept floating, to maintain the output voltage to ground voltage within ELV or SELV limits.

For all input sources, other than DC MAINS, where the input voltage is between 60 and 75 Vdc (Classified as TNV-2 in Europe), the following must be adhered to, if the converter's output is to be evaluated for SELV:

- The input source is to be provided with reinforced insulation from any hazardous voltage, including the AC mains.
- One VI pin and one VO pin are to be reliably earthed, or both the input and output pins are to be kept floating.
- Another SELV reliability test is conducted on the whole system, as required by the safety agencies, on the combination of supply source and the subject module to verify that under a single fault, hazardous voltages do not appear at the module's output.

The power module has ELV (extra-low voltage) outputs when all inputs are ELV.

All flammable materials used in the manufacturing of these modules are rated 94V-0, and UL60950A.2 for reduced thicknesses. The input to these units is to be provided with a maximum 10A normal-blow fuse in the ungrounded lead.

## Feature Descriptions

### Overcurrent Protection

To provide protection in a fault output overload condition, the module is equipped with internal current-limiting circuitry and can endure current limit for few seconds. If overcurrent persists for few seconds, the module will shut down and remain latch-off.

The overcurrent latch is reset by either cycling the input power or by toggling the on/off pin for one second. If the output overload condition still exists when the module restarts, it will shut down again. This operation will continue indefinitely until the overcurrent condition is corrected.

An auto-restart option is also available.

### Remote On/Off

Two remote on/off options are available. Positive logic remote on/off turns the module on during a logic-high voltage on the ON/OFF pin, and off during a logic low. Negative logic remote on/off turns the module off during a logic high and on during a logic low. Negative logic, device code suffix "1," is the factory-preferred configuration.

To turn the power module on and off, the user must supply a switch to control the voltage between the on/off terminal and the VI(-) terminal (Von/off). The switch can be an open collector or equivalent (see Figure 10). A logic low is Von/off = 0 V to 1.2 V. The maximum Ion/off during a logic low is 1 mA. The switch should maintain a logic-low voltage while sinking 1 mA.

During a logic high, the maximum Von/off generated by the power module is 15 V. The maximum allowable leakage current of the switch at Von/off = 15V is 50  $\mu$ A.

If not using the remote on/off feature, do one of the following to turn the unit on

For negative logic, short ON/OFF pin to VI(-).  
For positive logic: leave ON/OFF pin open.

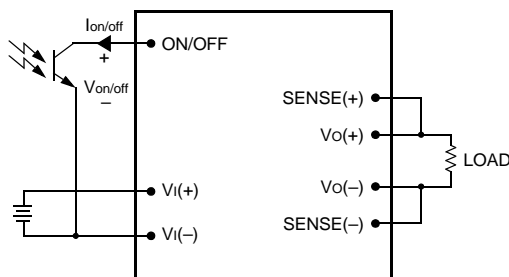

Figure 52. Remote On/Off Implementation.

### Remote Sense

Remote sense minimizes the effects of distribution losses by regulating the voltage at the remote-sense connections. The voltage between the remote-sense pins and the output terminals must not exceed the output voltage sense range given in Lineage Power

the Feature Specifications table i.e.:

$$[Vo(+)-Vo(-)]-[SENSE(+)-SENSE(-)] \leq 10\% \text{ of } Vo, \text{ rated}$$

The voltage between the Vo(+) and Vo(-) terminals must not exceed the minimum output overvoltage shutdown value indicated in the Feature Specifications table. This limit includes any increase in voltage due to remote-sense compensation and output voltage set-point adjustment (trim). See Figure 53.

If not using the remote-sense feature to regulate the output at the point of load, then connect SENSE(+) to Vo(+) and SENSE(-) to Vo(-) at the module.

Although the output voltage can be increased by both the remote sense and by time trim, the maximum increase for the output voltage is not the sum of both. The maximum increase is the larger of either the remote sense or the trim.

The amount of power delivered by the module is defined as the voltage at the output terminals multiplied by the output current. When using remote sense and trim: the output voltage of the module can be increased, which at the same output current would increase the power output of the module. Care should be taken to ensure that the maximum output power of the module remains at or below the maximum rated power.

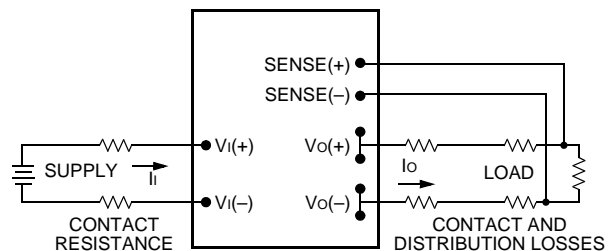

Figure 53. Effective Circuit Configuration for Single-Module Remote-Sense Operation Output Voltage.

### Output Overvoltage Protection

The output overvoltage protection consists of circuitry that monitors the voltage on the output terminals. If the voltage on the output terminals exceeds the over voltage protection threshold, then the module will shutdown and latch off. The overvoltage latch is reset by either cycling the input power for one second or by toggling the on/off signal for one second.

The protection mechanism is such that the unit can continue in this condition until the fault is cleared.

### Overtemperature Protection

These modules feature an overtemperature protection circuit to safeguard against thermal damage. The circuit shuts down and latches off the module when the maximum device reference temperature is exceeded. The module can be restarted by cycling the dc input power for at least one second or by toggling the remote on/off signal for at least one second.

## Feature Descriptions (Continued)

### Output Voltage Set-Point Adjustment (Trim)

Trimming allows the user to increase or decrease the output voltage set point of a module. This is accomplished by connecting an external resistor between the TRIM pin and either the SENSE(+) or SENSE(-) pins. The trim resistor should be positioned close to the module.

If not using the trim feature, leave the TRIM pin open.

With an external resistor between the TRIM and SENSE(-) pins ( $R_{adj-down}$ ), the output voltage set point ( $V_{o,adj}$ ) decreases (see Figure 54). The following equation determines the required external-resistor value to obtain a percentage output voltage change of  $D\%$ .

**For Output Voltage: 1.0V - 12V**

$$R_{adj-down} = \left[ \frac{510}{\Delta\%} - 10.2 \right] k\Omega$$

With an external resistor connected between the TRIM and SENSE(+) pins ( $R_{adj-up}$ ), the output voltage set point ( $V_{o,adj}$ ) increases (see Figure 55).

The following equation determines the required external-resistor value to obtain a percentage output voltage change of  $D\%$

**For Output Voltage: 1.5V - 12V**

$$R_{adj-up} = \left[ \frac{5.1 * V_o * (100 + \Delta\%)}{1.225 \Delta\%} - \frac{510}{\Delta\%} - 10.2 \right] k\Omega$$

**For Output Voltage: 1.2V, 1.0V**

$$R_{adj-up} = \left[ \frac{5.1 V_o (100 + \Delta\%)}{0.6 \Delta\%} - \frac{510}{\Delta\%} - 10.2 \right] k\Omega$$

The voltage between the  $V_o(+)$  and  $V_o(-)$  terminals must not exceed the minimum output overvoltage shut-down value indicated in the Feature Specifications table. This limit includes any increase in voltage due to remote-sense compensation and output voltage set-point adjustment (trim). See Figure 53.

Although the output voltage can be increased by both the remote sense and by the trim, the maximum increase for the output voltage is not the sum of both. The maximum increase is the larger of either the remote sense or the trim.

The amount of power delivered by the module is defined as the voltage at the output terminals multiplied by the output current. When using remote sense and trim, the output voltage of the module can be increased, which at the same output current would increase the power output of the module. Care should be taken to ensure that the maximum output power of the module remains at or below the maximum rated power.

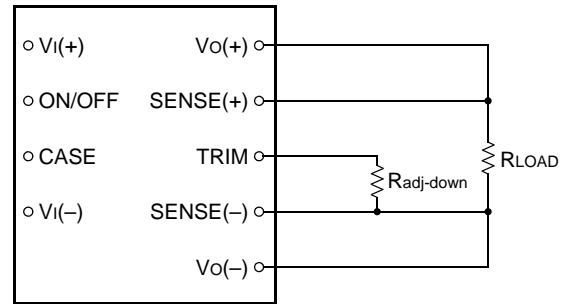

Figure 54. Circuit Configuration to Decrease Output Voltage.

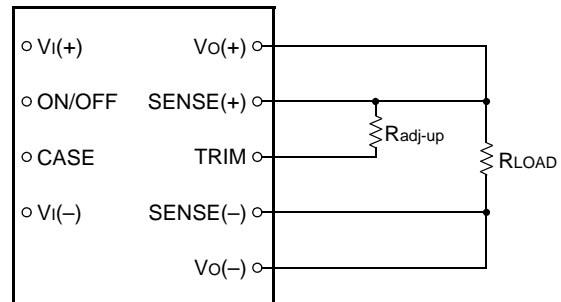
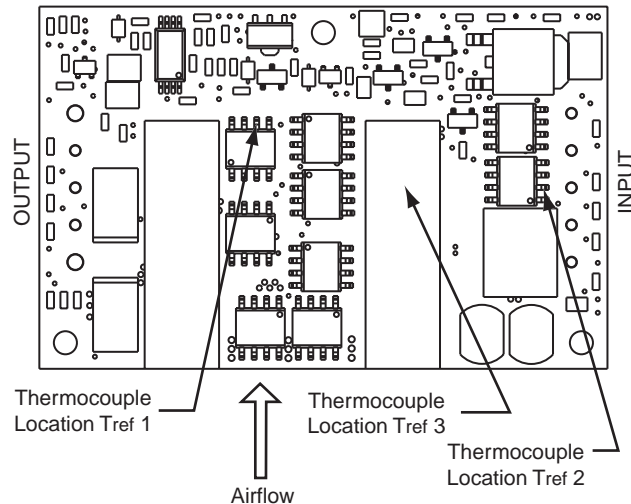

Figure 55. Circuit Configuration to Increase Output Voltage.

## Thermal Considerations

The power modules operate in a variety of thermal environments; however, sufficient cooling should be provided to help ensure reliable operation of the unit. Heat-dissipating components are mounted on the top side of the module. Heat is removed by conduction, convection and radiation to the surrounding environment. Proper cooling can be verified by measuring the temperature of selected components on the topside of the power module (See 56). Peak temperature (Tref) can occur at any of these positions indicated in Figure 50.



Note: Top view, pin locations are for reference only.

Figure 56. Temperature Measurement Location.

The temperature at any one of these locations should not exceed per 1 to ensure reliable operation of the power module. The output power of the module should not exceed the rated power for the module as listed in the Ordering Information table.

Although the maximum Tref temperature of the power modules is per 1, you can limit these temperatures to a lower value for extremely high reliability.

Table 1. Device Temperature

| Output Voltage | Device | Temperature (°C) |
|----------------|--------|------------------|
| 1.0V           | Tref1  | 116              |
| 1.2V           | Tref1  | 119              |
| 1.5V           | Tref1  | 118              |
| 1.8V           | Tref1  | 117              |
| 2.5V           | Tref1  | 118              |
| 3.3V           | Tref1  | 114              |
|                | Tref2  | 112              |
|                | Tref3  | 130              |
| 5V             | Tref1  | 113              |
| 12V            | Tref1  | 118              |

## Heat Transfer Without Heat Sinks

Increasing airflow over the module enhances the heat transfer via convection. Figures 57 through 64 shows the maximum current that can be delivered by the corresponding module without exceeding the maximum case temperature versus local ambient temperature (TA) for natural convection through 2 m/s (400 ft./min.).

Note that the natural convection condition was measured at 0.05 m/s to 0.1 m/s (10ft./min. to 20 ft./min.); however, systems in which these power modules may be used typically generate natural convection airflow rates of 0.3 m/s (60 ft./min.) due to other heat dissipating components in the system. The use of output power derating curve is shown in the following example.

What is the minimum airflow necessary for a QRW035A0F operating at VI = 48 V, an output current of 23A, and a maximum ambient temperature of 70 °C.

Solution

Given: VI = 48V

Io = 23A

TA = 70 °C

Determine airflow (v) (Use Figure 62):

v = 1m/sec. (200ft./min.)

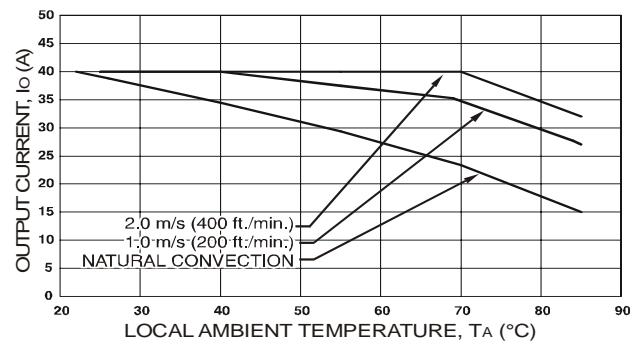

Figure 57. Output Power Derating for QRW040A0S1R0 (Vo = 1.0V) in Transverse Orientation with No Baseplate; Airflow direction from VIN (+) to VIN (-); VIN = 48V.

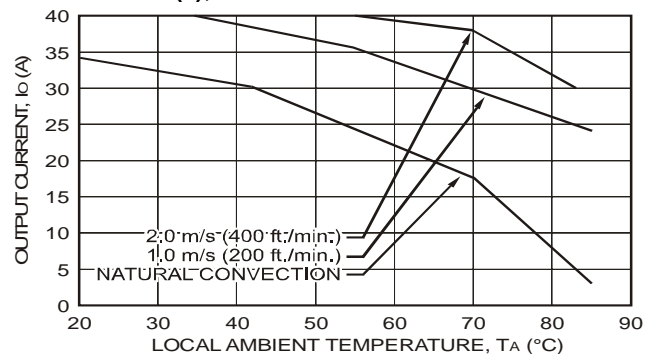

Figure 58. Output Power Derating for QRW040A0P (Vo = 1.2V) in Transverse Orientation with No Baseplate; Airflow direction from VIN (+) to VIN (-); VIN = 48V.

Thermal Considerations (continued)

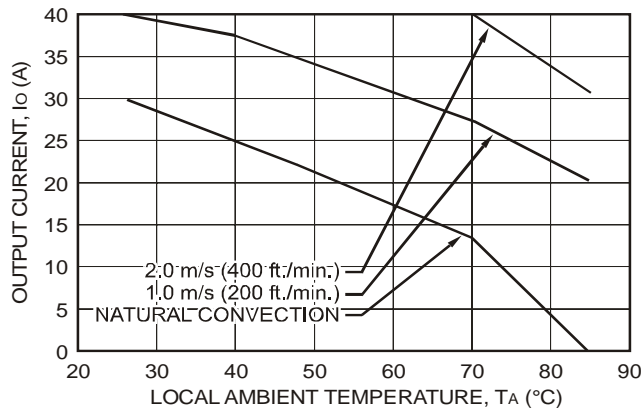

Figure 59. Output Power Derating for QRW040A0M ( $V_o = 1.5V$ ) in Transverse Orientation with No Baseplate; Airflow direction from VIN (+) to VIN (-); VIN = 48V.

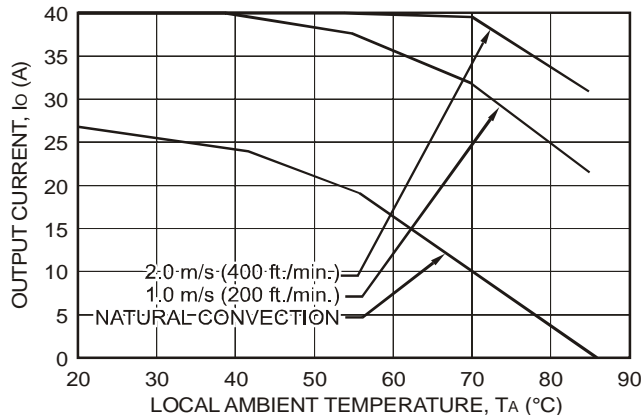

Figure 60. Output Power Derating for QRW040A0Y ( $V_o = 1.8V$ ) in Transverse Orientation with No Baseplate; Airflow direction from VIN (+) to VIN (-); VIN = 48V.

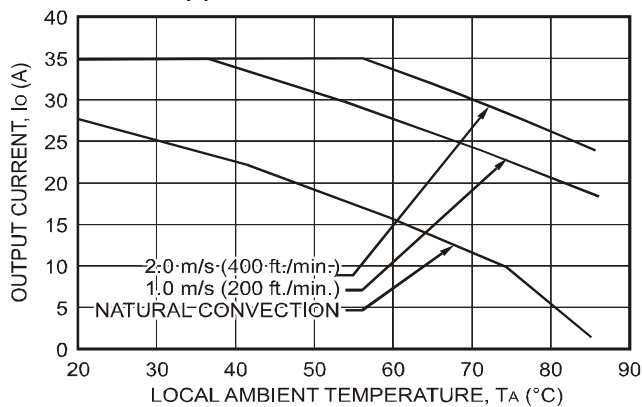

Figure 61. Output Power Derating for QRW0350G ( $V_o = 2.5$ ) in Transverse Orientation with No Baseplate; Airflow direction from VIN (+) to VIN (-); VIN = 48V.

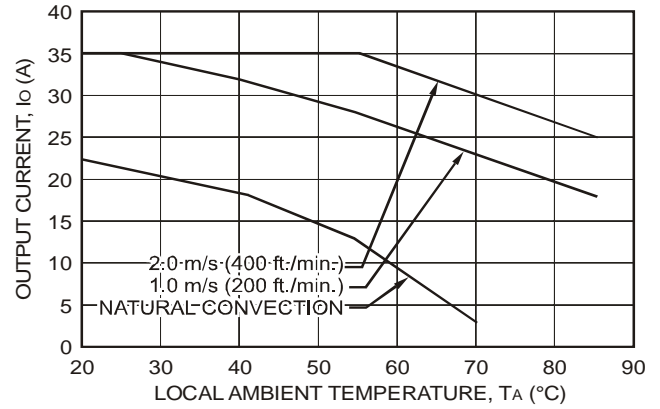

Figure 62. Output Power Derating for QRW035A0F ( $V_o = 3.3V$ ) in Transverse Orientation with No Baseplate; Airflow direction from VIN (+) to VIN (-); VIN = 48V.

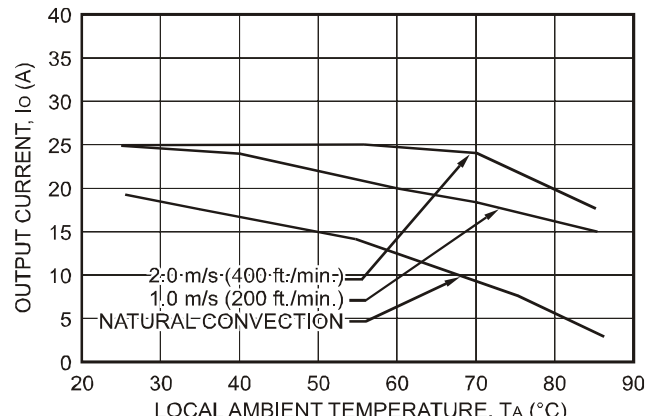

Figure 63. Output Power Derating for QRW025A0A ( $V_o = 5V$ ) in Transverse Orientation with No Baseplate; Airflow direction from VIN (+) to VIN (-); VIN = 48V.

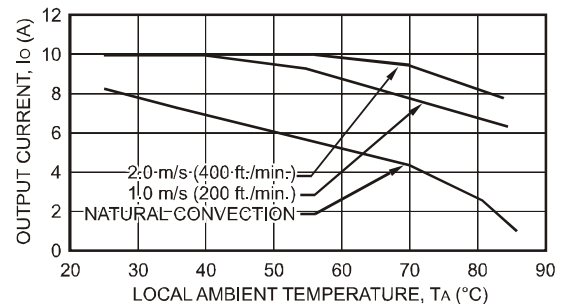

Figure 64. Output Power Derating for QRW010A0B ( $V_o = 12V$ ) in Transverse Orientation with No Baseplate; Airflow direction from VIN (+) to VIN (-); VIN = 48V.



## Outline Diagram

Dimensions are in millimeters and (inches)  
Tolerances: x.x mm 0.5 mm (x.xx in. 0.02 in.)  
x.xx mm 0.25 mm (x.xxx in. 0.010 in.)

Top View

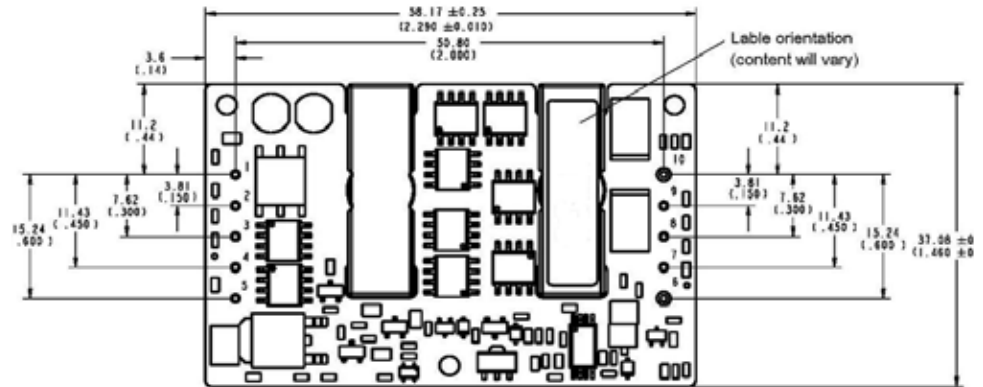

Side View

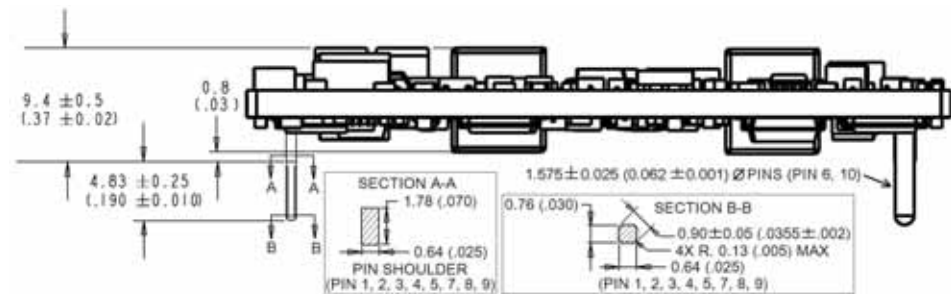

Bottom View

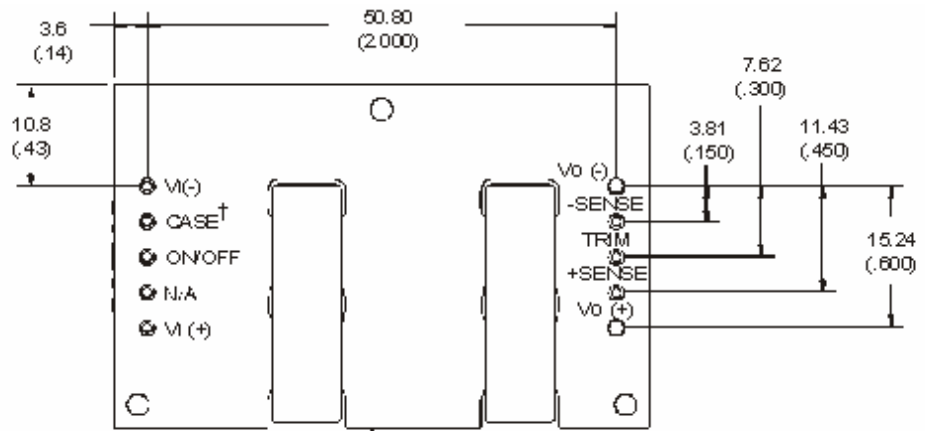

DEPANELIZATION TABS MAY EXTEND UP TO 0.010 INCH OVER MAXIMUM STANDARD TOLERANCE (4 PLACES).

\*Top Side label includes Lineage name, product designation, and data code.  
†Optional Features, Pin is not present unless one of these options is specified.

## Recommended Hole Pattern

Dimensions are in millimeters and (inches).

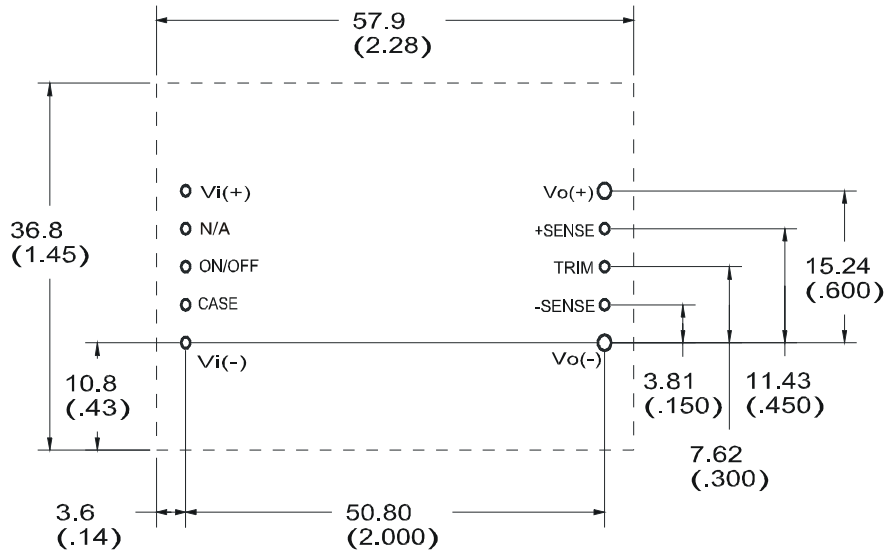

| Name   | Pin No. | Function                |
|--------|---------|-------------------------|
| Vi(+)  | 1       | Positive input voltage  |
| N/A    | 2       |                         |
| ON/OFF | 3       | Remote On/Off signal    |
| CASE*  | 4       | Connected to base plate |
| Vi(-)  | 5       | Negative input voltage  |
| Vo(-)  | 6       | Negative output voltage |
| -SENSE | 7       | Negative remote sense   |
| TRIM   | 8       | Output voltage trim     |
| +SENSE | 9       | Positive remote sense   |
| Vo(+)  | 10      | Positive output voltage |

\* CASE pin only available on -H option modules.

## Through-Hole Lead-Free Soldering Information

The RoHS-compliant through-hole products use the SAC (Sn/Ag/Cu) Pb-free solder and RoHS-compliant components. They are designed to be processed through single or dual wave soldering machines. The pins have an RoHS-compliant finish that is compatible with both Pb and Pb-free wave soldering processes. A maximum preheat rate of 3°C/s is suggested. The wave preheat process should be such that the temperature of the power module board is kept below 210°C. For Pb solder, the recommended pot temperature is 260°C, while the Pb-free solder pot is 270°C max. Not all RoHS-compliant through-hole products can be processed with paste-through-hole Pb or Pb-free reflow process. If additional information is needed, please consult with your Lineage Power System representative for more details.

## Post Solder Cleaning and Drying Considerations

Post solder cleaning is usually the final circuit-board assembly process prior to electrical board testing. The result of inadequate cleaning and drying can affect both the reliability of a power module and the testability of the finished circuit-board assembly. For guidance on appropriate soldering, cleaning and drying procedures, refer to Lineage Power *Board Mounted Power Modules: Soldering and Cleaning* Application Note (AP01-056EPS).

## Ordering Information

For assistance in ordering, please contact your Lineage Power Account Manager or Field Application Engineer for pricing and availability.

| Input Voltage  | Output Voltage | Output Current | Efficiency | Connector Type | Device Code   | Comcodes    |
|----------------|----------------|----------------|------------|----------------|---------------|-------------|
| 48V (36-75Vdc) | 1.0V           | 40A            | 83%        | Through hole   | QRW040A0S1R01 | 108967712   |
| 48V (36-75Vdc) | 1.2V           | 40A            | 85%        | Through hole   | QRW040A0P1    | 108965542   |
| 48V (36-75Vdc) | 1.5V           | 40A            | 86%        | Through hole   | QRW040A0M1    | 108965534   |
| 48V (36-75Vdc) | 1.8V           | 40A            | 87%        | Through hole   | QRW040A0Y1    | 108965559   |
| 48V (36-75Vdc) | 2.5V           | 35A            | 90%        | Through hole   | QRW035A0G1    | 108965526   |
| 48V (36-75Vdc) | 3.3V           | 35A            | 91%        | Through hole   | QRW035A0F     | 108965989   |
| 48V (36-75Vdc) | 3.3V           | 35A            | 91%        | Through hole   | QRW035A0F1    | 108965518   |
| 48V (36-75Vdc) | 3.3V           | 35A            | 91%        | Through hole   | QRW035A0F1-H  | 108967720   |
| 48V (36-75Vdc) | 3.3V           | 35A            | 91%        | Through hole   | QRW035A0F71-H | 108967829   |
| 48V (36-75Vdc) | 5V             | 25A            | 92%        | Through hole   | QRW025A0A1    | 108965500   |
| 48V (36-75Vdc) | 5V             | 25A            | 92%        | Through hole   | QRW025A0A641  | 108985672   |
| 48V (36-75Vdc) | 12V            | 10A            | 91%        | Through hole   | QRW010A0B1    | 108967167   |
| 48V (36-75Vdc) | 1.5V           | 40A            | 86%        | Through hole   | QRW040A0M1Z   | CC109107521 |
| 48V (36-75Vdc) | 2.5V           | 35A            | 90%        | Through hole   | QRW035A0G1Z   | CC109107505 |
| 48V (36-75Vdc) | 3.3V           | 35A            | 91%        | Through hole   | QRW035A0F1Z   | 108995230   |
| 48V (36-75Vdc) | 5V             | 25A            | 92%        | Through hole   | QRW025A0A1Z   | CC109101474 |
| 48V (36-75Vdc) | 12V            | 10A            | 91%        | Through hole   | QRW010A0B1Z   | CC109102992 |

Optional features can be ordered using the suffixes shown in table below. The suffixes follow the last letter of the device code and are placed in descending order. For example, the device codes for a QW010/015/0201 module with the following options are shown below:

Auto-restart after over current shutdown QRW035A0F41

| Option  | Suffix |
|---|--------|
| Negative Logic remote on/off                            | 1      |
| Auto-restart after fault shutdown                       | 4      |
| Base plate version for Heat Sink attachment             | -H     |
| Pin Length: 3.68 mm ± 0.25 mm<br>(0.145 in. ± 0.010 in) | 6      |
| Case Pin (Only available with -H option)                | 7      |
| Pin Length: 2.79 mm ± 0.25 mm<br>(0.110 in. ± 0.010 in) | 8      |
| RoHS compliant  | -Z     |

Note: Legacy device codes may contain a -B option suffix to indicate 100% factory Hi-Pot tested to the isolation voltage specified in the Absolute Maximum Ratings table. The 100% Hi-Pot test is now applied to all device codes, with or without the -B option suffix. Existing comcodes for devices with the -B suffix are still valid; however, no new comcodes for devices containing the -B suffix will be created.



**World Wide Headquarters**  
**Lineage Power Corporation**  
 3000 Skyline Drive, Mesquite, TX 75149, USA  
**+1-800-526-7819**  
 (Outside U.S.A.: +1-972-284-2626)  
**www.lineagepower.com**  
**e-mail: techsupport1@lineagepower.com**

**Asia-Pacific Headquarters**  
 Tel: +65 6416 4283

**Europe, Middle-East and Africa Headquarters**  
 Tel: +49 89 6089 286

**India Headquarters**  
 Tel: +91 80 28411633

Lineage Power reserves the right to make changes to the product(s) or information contained herein without notice. No liability is assumed as a result of their use or application. No rights under any patent accompany the sale of any such product(s) or information.

© 2008 Lineage Power Corporation, (Mesquite, Texas) All International Rights Reserved.