

QW010/015/020 Series Power Modules: dc-dc Converters; 36 Vdc to 75 Vdc Input; 1.2 Vdc to 5.0 Vdc Output; 10 A to 20 A

RoHS Compliant



Applications

- Distributed Power Architectures
- Wireless Networks
- Access and Optical Network Equipment
- Enterprise Networks
- Latest generation IC's (DSP, FPGA, ASIC) and Microprocessor-powered applications.

Options

- Remote On/Off negative logic
- Surface-mount package (-S Suffix)
- Basic Insulation (-B Suffix)
- Baseplate version for heatsink attachment (only Through-hole version)

Description

The QW series power modules are isolated dc-dc converters that can deliver up to 20A of output current and provide a precisely regulated output voltage over a wide range of input voltages ($V_I = 36\text{Vdc}$ to 75Vdc). The modules achieve full load efficiency of 91% at 3.3V output voltage. The open frame modules, available in both surface-mount and through-hole packaging, enable designers to develop cost- and space-efficient solutions. Standard features include remote On/Off, output voltage adjustment, remote sense, overvoltage, overcurrent and overtemperature protection.

Features

- Compatible with RoHS EU Directive 200295/EC (-Z Versions)
- Compatible in RoHS EU Directive 200295/EC with lead solder exemption (non -Z versions)
- Delivers up to 20 A output current
- High efficiency: 91% at 3.3V full load ($V_{IN} = 48\text{V}$)
- Small size and low profile:
36.8 mm x 57.9 mm x 8.50 mm
(1.45 in x 2.28 in x 0.335 in)
- Low output ripple and noise
- Exceptional thermal performance
- Industry standard "quarter-brick" footprint
- High reliability: MTBF > 3.1M hours at 25 °C
- Remote On/Off positive logic (primary referenced)
- Constant switching frequency (320 KHz typical)
- Remote Sense
- Output overvoltage and overcurrent protection
- Overtemperature protection
- Adjustable output voltage ($\pm 10\%$)
- Meets the voltage and current requirements for ETSI 300-132-2 and complies with and is approved for Basic Insulation rating per IEC60950 3rd (-B version only)
- UL* 60950 Recognized, CSA[†] C22.2 No. 60950-00 Certified, and VDE[‡] 0805 (IEC60950, 3rd edition) Licensed
- CE mark meets 73/23/EEC and 93/68/EEC directives[§]
- ISO** 9001 and ISO14001 certified manufacturing facilities

* UL is a registered trademark of Underwriters Laboratories, Inc.

† CSA is a registered trademark of Canadian Standards Association.

‡ VDE is a trademark of Verband Deutscher Elektrotechniker e.V.

§ This product is intended for integration into end-use equipment. All the required procedures for CE marking of end-use equipment should be followed. (The CE mark is placed on selected products.)

** ISO is a registered trademark of the International Organization of Standards

Absolute Maximum Ratings

Stresses in excess of the absolute maximum ratings can cause permanent damage to the device. These are absolute stress ratings only, functional operation of the device is not implied at these or any other conditions in excess of those given in the operations sections of the data sheet. Exposure to absolute maximum ratings for extended periods can adversely affect the device reliability.

| Parameter | Device | Symbol | Min | Max | Unit |
|---|--------|-----------|-----|-----|------|
| Input Voltage:Continuous | All | VI | — | 75 | Vdc |
| Transient (100ms) | All | VI, trans | — | 100 | Vdc |
| Operating Ambient Temperature (See Thermal Considerations section) | All | TA | -40 | 85 | °C |
| Storage Temperature | All | Tstg | -55 | 125 | °C |

Electrical Specifications

Unless otherwise indicated, specifications apply over all operating input voltage, resistive load, and temperature conditions.

| Parameter | Device | Symbol | Min | Typ | Max | Unit |
|---|--------|------------------|-----|-----|-----|------------------|
| Operating Input Voltage | All | VIN | 36 | 48 | 75 | Vdc |
| Maximum Input Current (VI = 0 V to 75 V; IO = IO, max) | All | II, max | — | — | 2.0 | Adc |
| Inrush Transient | All | I ² t | | | 0.2 | A ² s |
| Input Reflected Ripple Current, peak-peak (5 Hz to 20 MHz, 12 µH source impedance See Test configuration section) | All | II | | 10 | | mAp-p |
| Input Ripple Rejection (120 Hz) | All | | | 50 | | dB |

CAUTION: This power module is not internally fused. An input line fuse must always be used.

This power module can be used in a wide variety of applications, ranging from simple stand-alone operation to an integrated part of a sophisticated power architecture. To preserve maximum flexibility, internal fusing is not included however, to achieve maximum safety and system protection, always use an input line fuse. The safety agencies require a time-delay fuse with a maximum rating of 5 A (see Safety Considerations section). Based on the information provided in this data sheet on inrush energy and maximum dc input current, the same type of fuse with a lower rating can be used. Refer to the fuse manufacturer's data sheet for further information.

Electrical Specifications (continued)

| Parameter | Device | Symbol | Min | Typ | Max | Unit |
|--|---------|---------|------|-------|--------|----------|
| Output Voltage Set Point (VI = 48 Vdc; IO = IO, min to IO, max; TA = 25 °C) | P | VO, set | 1.18 | 1.2 | 1.22 | Vdc |
| | M | VO, set | 1.47 | 1.5 | 1.52 | Vdc |
| | Y | VO, set | 1.76 | 1.8 | 1.84 | Vdc |
| | G | VO, set | 2.45 | 2.5 | 2.55 | Vdc |
| | F | VO, set | 3.23 | 3.3 | 3.37 | Vdc |
| | A | VO, set | 4.9 | 5.0 | 5.1 | Vdc |
| Output Voltage (Over all operating input voltage, resistive load, and temperature conditions until end of life. See Test Configurations section.) | P | VO | 1.16 | — | 1.24 | Vdc |
| | M | VO | 1.45 | — | 1.55 | Vdc |
| | Y | VO | 1.74 | — | 1.85 | Vdc |
| | G | VO | 2.42 | — | 2.57 | Vdc |
| | F | VO | 3.20 | — | 3.40 | Vdc |
| | A | VO | 4.85 | — | 5.15 | Vdc |
| Output Regulation: Line (VI = 36 V to 75 V) Load (IO = IO, min to IO, max) Temperature (TA = -40 °C to + 85 °C) | All | — | — | — | ±5 | mV |
| | All | — | — | — | ±5 | mV |
| | All | — | — | — | 1.0 | %VO, set |
| Output Ripple and Noise Voltage See Test Configurations section Measured across 10 µF Tantalum, 1 µF ceramic, VI = 48 Vdc, TA = 25 °C, IO = IO,max | All | | — | 12 | — | mVrms |
| | All | | — | 45 | 75 | mVp-p |
| External Load Capacitance | All | CO | 0 | — | 10,000 | µF |
| Output Current | G,Y,M,P | IO | 0 | — | 20.0 | Adc |
| | F | IO | 0 | — | 15.0 | Adc |
| | A | IO | 0 | — | 10.0 | Adc |
| Output Current-limit Inception (VO = 90% of VO, set) | G,Y,M,P | IO | — | 23.5 | — | Adc |
| | F | IO | — | 17.5 | — | Adc |
| | A | IO | — | 11.75 | — | Adc |
| Output Short-circuit Current (Average) (VO = 0.25 V) | G,Y,M,P | IO | — | 13 | — | Adc |
| | F | IO | — | 10 | — | Adc |
| | A | IO | — | 7 | — | Adc |
| Efficiency (VI = 48 Vdc; IO = IO, max), TA = 25 °C | P | η | — | 84 | — | % |
| | M | η | — | 86 | — | % |
| | Y | η | — | 87 | — | % |
| | G | η | — | 89 | — | % |
| | F | η | — | 91 | — | % |
| | A | η | — | 92 | — | % |
| Switching Frequency | All | fsw | — | 320 | — | kHZ |

Electrical Specifications (continued)

| Parameter | Device | Symbol | Min | Typ | Max | Unit |
|--|--------|--------|-----|-----|-----|------|
| Dynamic Response (di/dt = 0.1 A/μs, VI = 48 V, TA = 25 °C) Cout = 220μF Electrolytic and 1μF tantalum. Load Change from IO = 50% to 75% of IO, max, Peak Deviation | All | — | — | 200 | — | mV |
| Settling Time (VO < 10% of peak deviation) | All | — | — | 0.2 | — | ms |
| Load Change from IO = 50% to 25% of IO, max, Peak Deviation | All | — | — | 200 | — | mV |
| Settling Time (VO < 10% of peak deviation) | All | — | — | 0.2 | — | ms |

Isolation Specifications

| Parameter | Symbol | Min | Typ | Max | Unit |
|-----------------------|--------|-----|------|------|------|
| Isolation Capacitance | Ciso | — | 1000 | — | PF |
| Isolation Resistance | Riso | 10 | — | — | MΩ |
| Isolation Voltage | Viso | — | — | 1500 | Vdc |

General Specifications

| Parameter | Min | Typ | Max | Unit |
|--|-----------|------------|-----|---------|
| Calculated MTBF (IO = 80% of IO, max TA = 25 °C) Tyco RIN (Reliability Information Notebook) Method | 3,178,000 | | | Hours |
| Weight | — | 27.4(0.97) | — | g (oz.) |

Feature Specifications

Unless otherwise indicated, specifications apply over all operating input voltage, resistive load, and temperature conditions. See Feature Descriptions for additional information.

| Parameter | Device | Symbol | Min | Typ | Max | Unit |
|---|---------------------------------|--|--|----------------------------|--|----------------------------|
| Remote On/Off Signal Interface (VI = VI,min to VI,max; open collector or compatible, signal referenced to VI(-) terminal) Negative Logic: Device Code Suffix "1": Logic Low—Module On / Logic High—Module Off Positive Logic: If Device Code Suffix "1" Is Not Specified: Logic Low—Module Off / Logic High—Module On Module Specifications: On/Off Current—Logic Low On/Off Voltage—Logic Low On/Off Voltage—Logic High (Ion/off = 0 mA) Open Collector Switch Specifications: Leakage Current During Logic High (Von/off = 15 V) Output Low Voltage During Logic Low (Ion/off = 1 mA) | All All All All All | Ion/off Von/off Von/off Ion/off Von/off | — -0.7 — — — | — — — — — | 1.0 1.2 15 50 1.2 | mA V V μA V |
| Turn-on Delay and Rise Times (at 80% of IO, max; TA = 25 °C): Case 1: On/Off Input Is Set for Logic High and then Input Power Is Applied (delay from point at which VI = VI, min until VO = 10% of VO, set). Case 2: Input Power Is Applied for at Least One Second, and Then the On/Off Input Is Set to Logic High (delay from point at which Von/off = 0.9 V until VO = 10% of VO, set). Output Voltage Rise Time (time for VO to rise from 10% of VO, nom to 90% of VO, set) | All All All | Tdelay Tdelay Trise | — — — | 17 3 13 | — — — | ms ms ms |
| Output voltage overshoot (IO = 80% of IO,max, VI = 48 Vdc TA = 25 °C) | All | | — | — | 5 | %VO,set |
| Output Voltage Adjustment (See Feature Descriptions section): Output Voltage Remote-sense Range | P,M,Y G,F,A | | — | — | 0.25 10 | V %VO, set |
| Output Voltage Set-point Adjustment Range (trim) | All | | 90 | — | 110 | %VO, set |
| Output Overvoltage Protection (clamp) | P M Y G F A | VO, ovsd VO, ovsd VO, ovsd VO, ovsd VO, ovsd VO, ovsd | 2.0 2.3 2.3 2.7 3.6 5.5 | — — — — — — | 2.4 2.7 2.7 3.7 4.5 7.2 | V V V V V V |
| Overtemperature Protection (VI = 75 V, IO = IO, max) See Figure 44 | All | TQ10 / TQ560 | — | 120 | — | °C |
| Input Undervoltage Lockout: Turn-on Threshold Turn-off Threshold | All All | | — 33 | 35 34 | 36 — | V V |

Characteristic Curves

The following figures provide typical characteristics curves for the QW020A0P1 ($V_O = 1.2V$) module at room temperature ($T_A = 25^\circ C$)

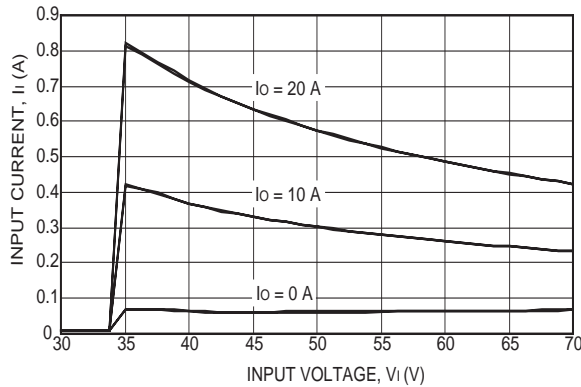

Figure 1. Input Voltage and Current Characteristics.

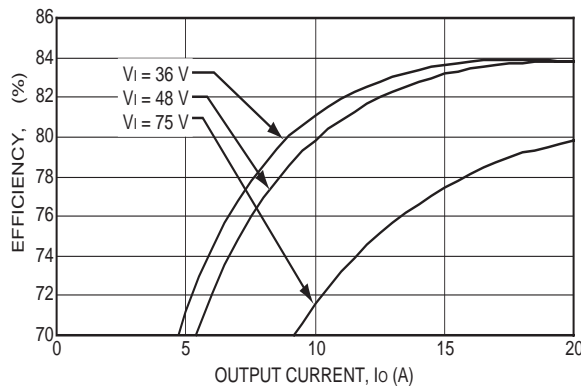

Figure 2. Converter Efficiency vs. Output Current.

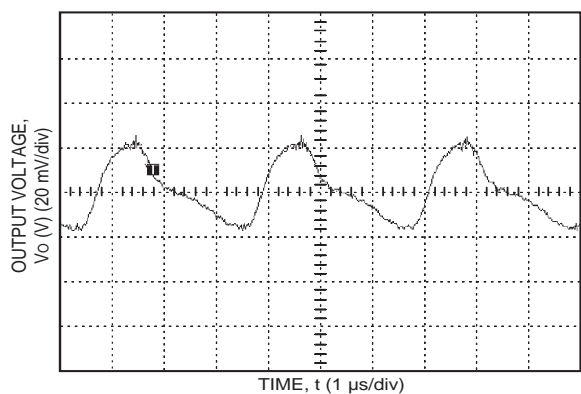

Figure 3. Output Ripple Voltage ($I_O = I_{O, max}$).

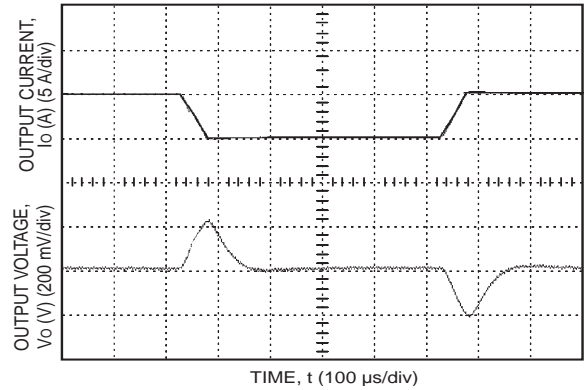

Figure 4. Transient Response to Step Decrease in Load from 50% to 25% of Full Load ($V_I = 48 V_{dc}$).

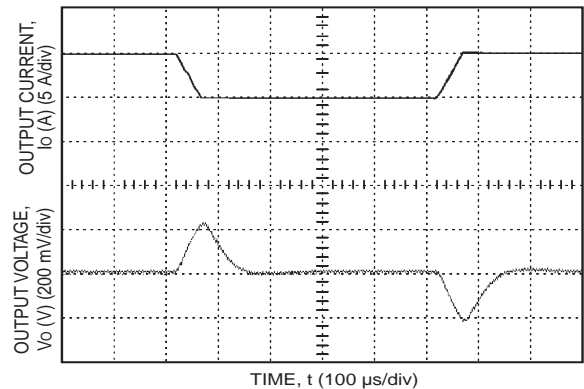

Figure 5. Transient Response to Step Increase in Load from 50% to 75% of Full Load ($V_I = 48 V_{dc}$).

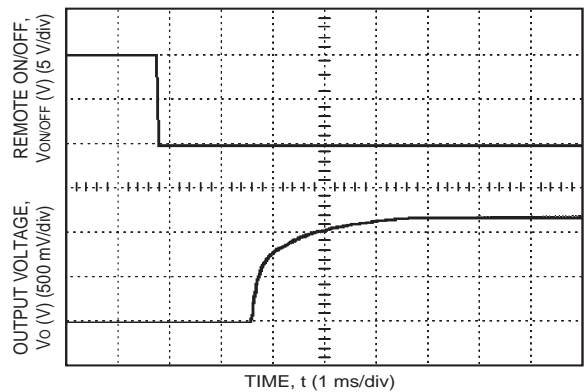

Figure 6. Start-up from Remote On/Off ($I_O = I_{O, max}$).

Characteristic Curves

The following figures provide typical characteristics curves for the QW020A0M1 ($V_O = 1.5\text{ V}$) module at room temperature ($T_A = 25\text{ }^\circ\text{C}$)

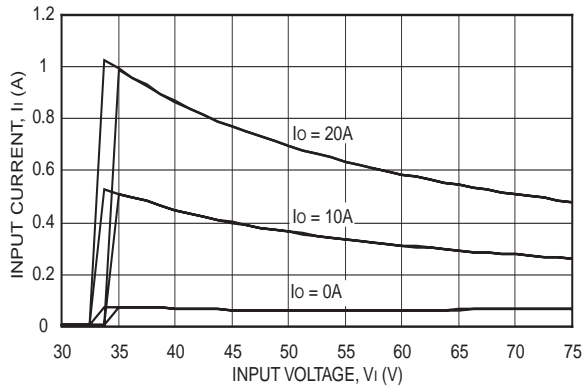

Figure 7. Input Voltage and Current Characteristics.

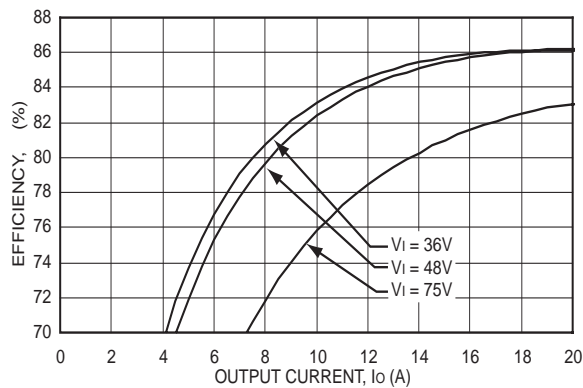

Figure 8. Converter Efficiency vs. Output Current.

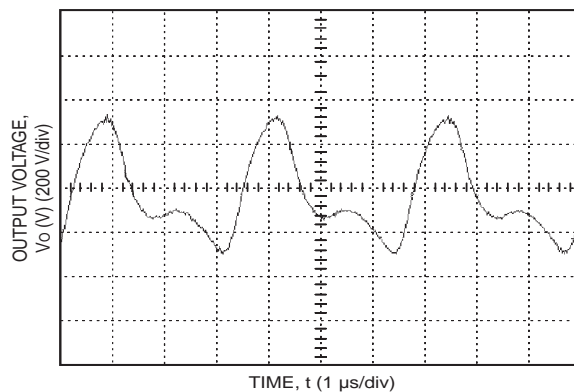

Figure 9. Output Ripple Voltage ($I_O = I_{O, \text{max}}$).

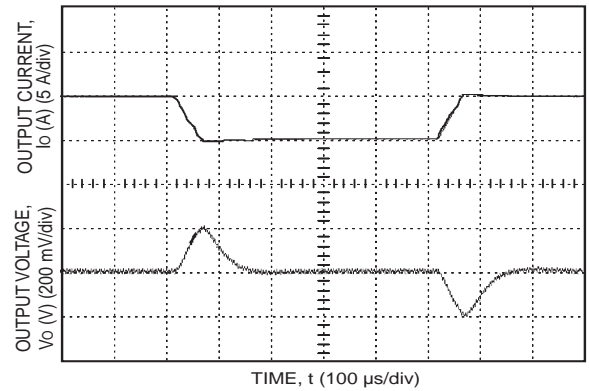

Figure 10. Transient Response to Step Decrease in Load from 50% to 25% of Full Load ($V_I = 48\text{ Vdc}$).

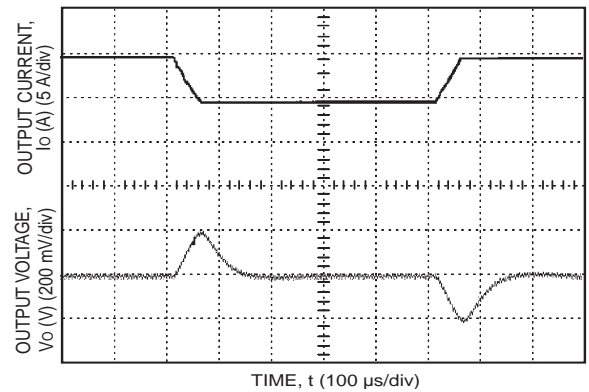

Figure 11. Transient Response to Step Increase in Load from 50% to 75% of Full Load ($V_I = 48\text{ Vdc}$).

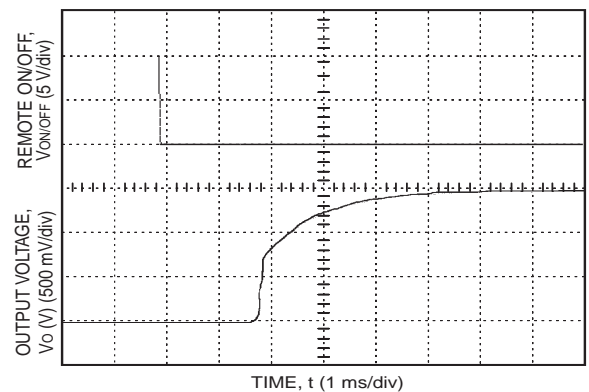

Figure 12. Start-up from Remote On/Off ($I_O = I_{O, \text{max}}$).

Characteristic Curves

The following figures provide typical characteristics curves for the QW020A0Y1 ($V_O = 1.8V$) module at room temperature ($T_A = 25^\circ C$)

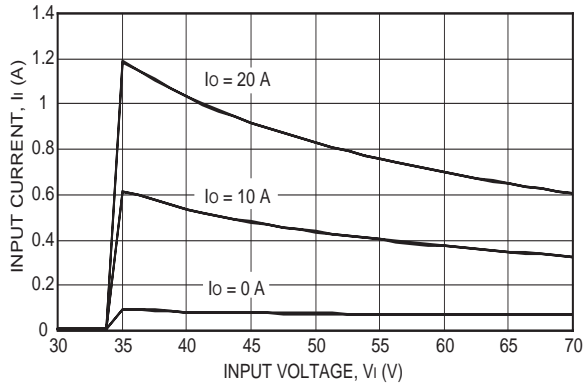

Figure 13. Input Voltage and Current Characteristics.

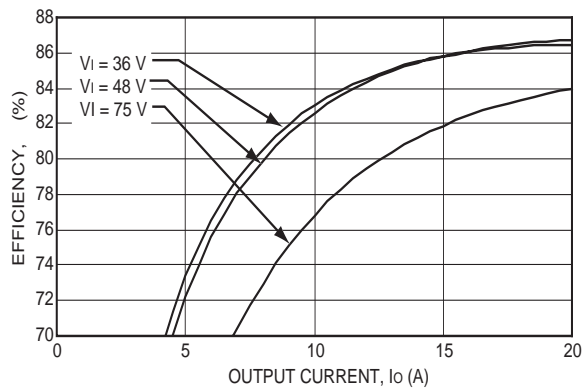

Figure 14. Converter Efficiency vs. Output Current.

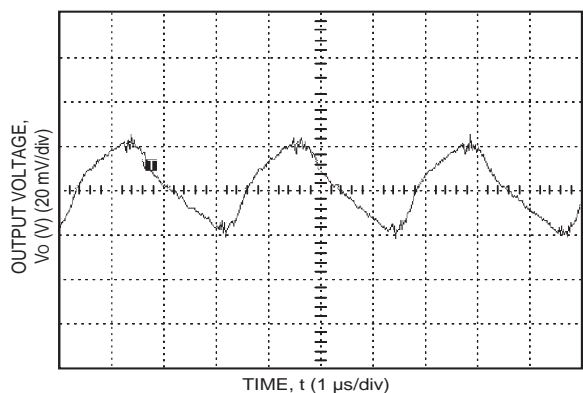

Figure 15. Output Ripple Voltage ($I_O = I_{O, max}$).

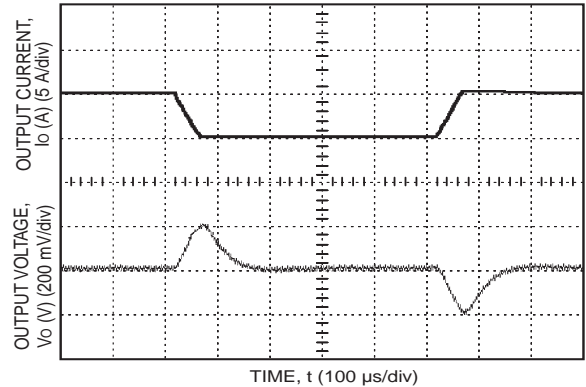

Figure 16. Transient Response to Step Decrease in Load from 50% to 25% of Full Load ($V_I = 48 V_{dc}$).

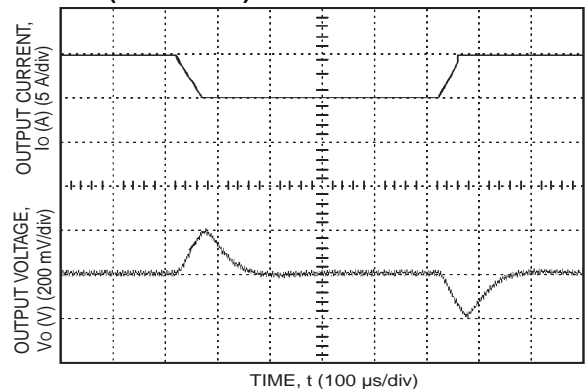

Figure 17. Transient Response to Step Increase in Load from 50% to 75% of Full Load ($V_I = 48 V_{dc}$).

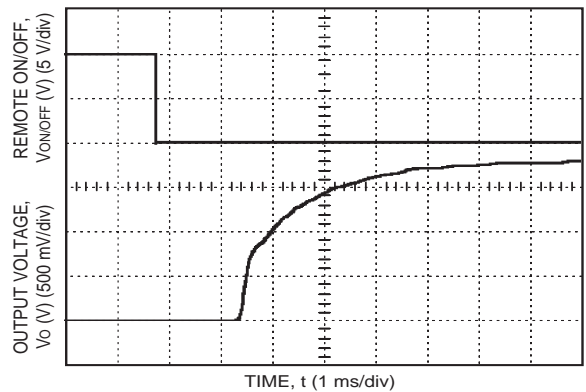

Figure 18. Start-up from Remote On/Off ($I_O = I_{O, max}$).

Characteristic Curves

The following figures provide typical characteristics curves for the QW020A0G1 ($V_O = 2.5\text{ V}$) module at room temperature ($T_A = 25\text{ }^\circ\text{C}$)

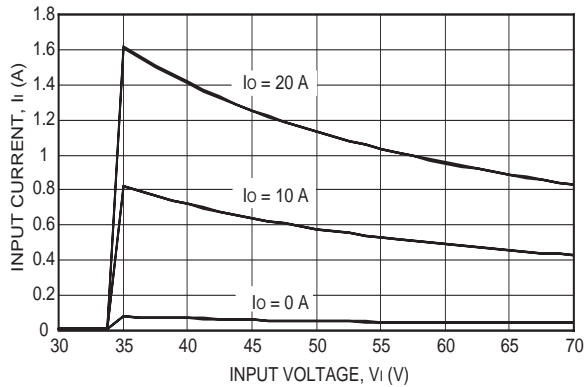

Figure 19. Input Voltage and Current Characteristics.

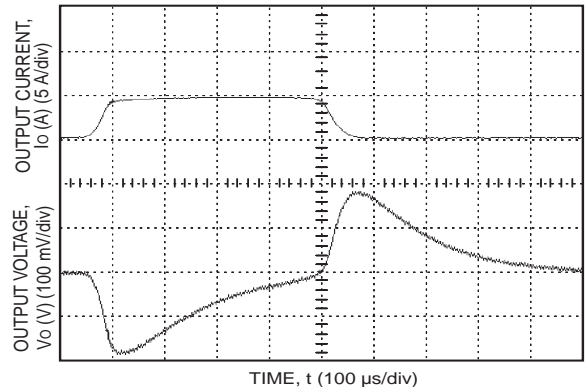

Figure 22. Transient Response to Step Decrease in Load from 50% to 25% of Full Load ($V_I = 48\text{ Vdc}$).

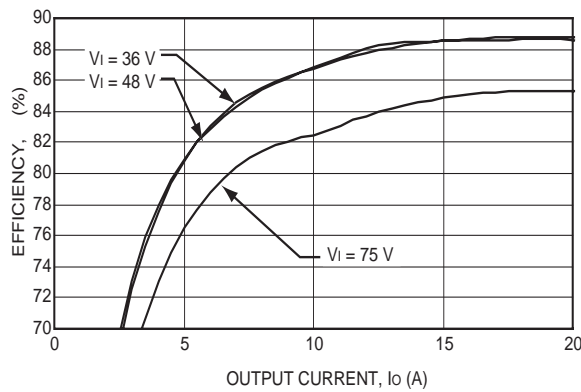

Figure 20. Converter Efficiency vs. Output Current.

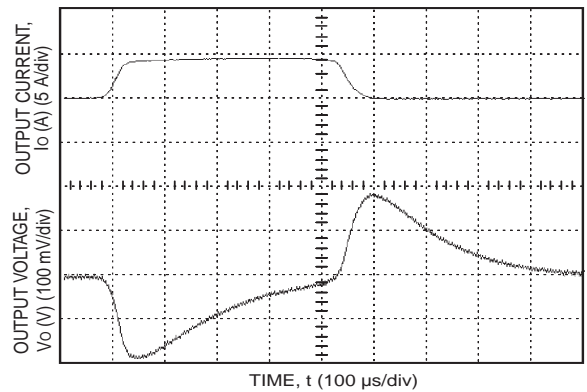

Figure 23. Transient Response to Step Increase in Load from 50% to 75% of Full Load ($V_I = 48\text{ Vdc}$).

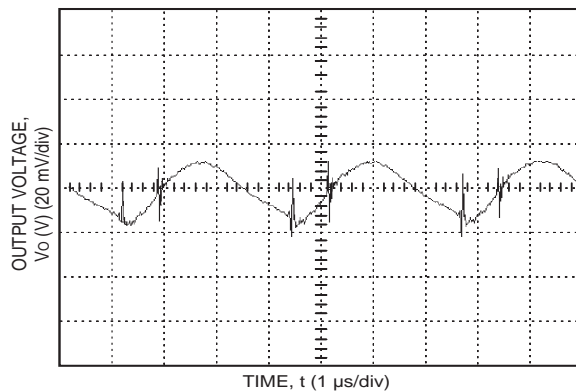

Figure 21. Output Ripple Voltage ($I_O = I_{O, \text{max}}$).

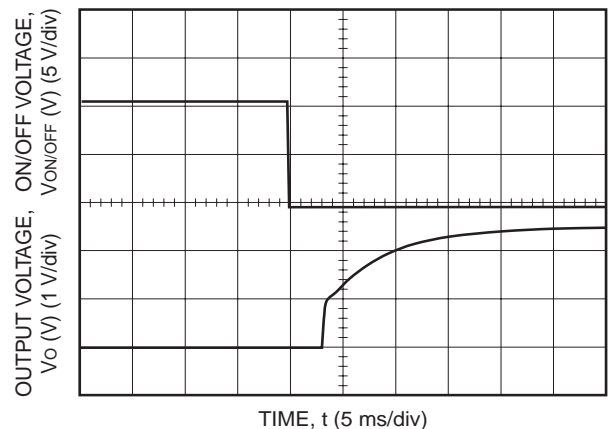

Figure 24. Start-up from Remote On/Off ($I_O = I_{O, \text{max}}$).

Characteristic Curves

The following figures provide typical characteristics curves for the QW015A0F1 ($V_O = 3.3\text{ V}$) module at room temperature ($T_A = 25\text{ }^\circ\text{C}$)

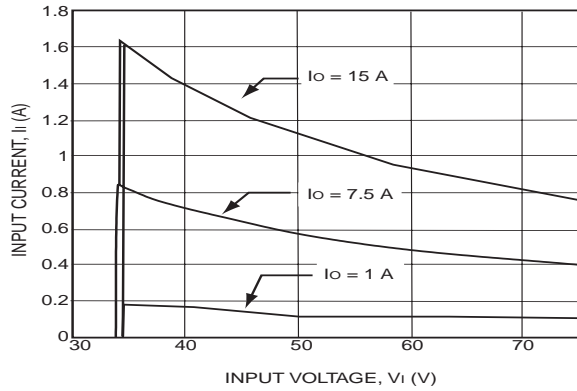

Figure 25. Input Voltage and Current Characteristics.

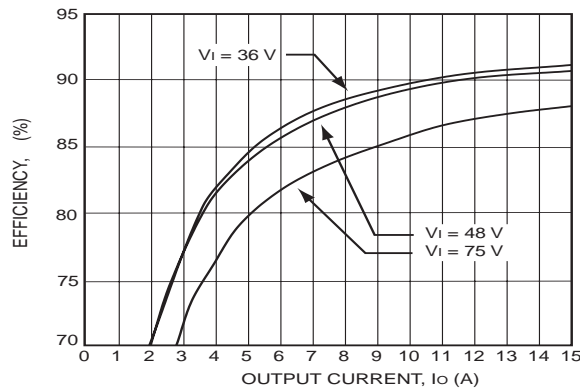

Figure 26. Converter Efficiency vs. Output Current.

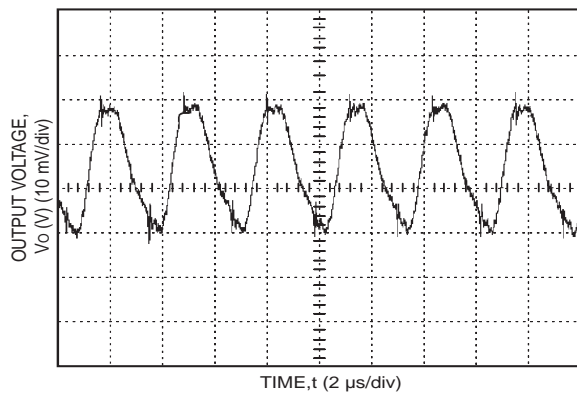

Figure 27. Output Ripple Voltage ($I_O = I_{O, \text{max}}$).

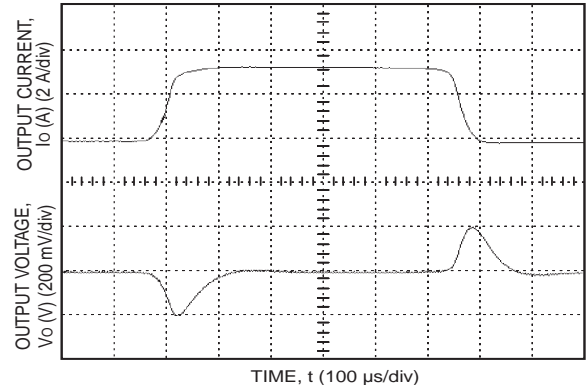

Figure 28. Transient Response to Step Decrease in Load from 50% to 25% of Full Load ($V_I = 48\text{ Vdc}$).

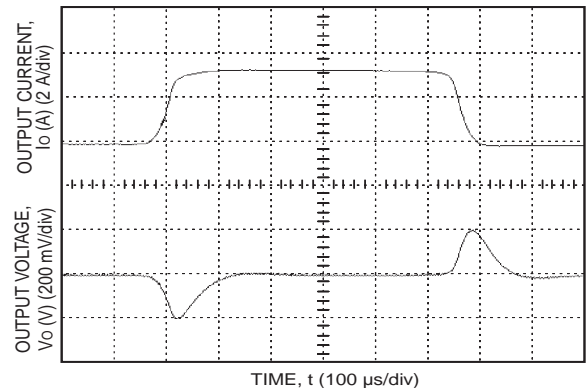

Figure 29. Transient Response to Step Increase in Load from 50% to 75% of Full Load ($V_I = 48\text{ Vdc}$).

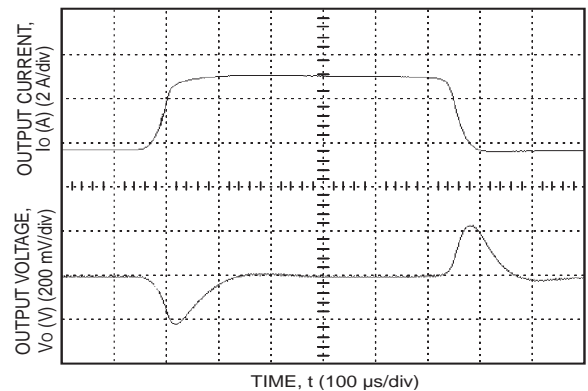

Figure 30. Start-up from Remote On/Off ($I_O = I_{O, \text{max}}$).

Characteristic Curves

The following figures provide typical characteristics curves for the QW010A0A1($V_O = 5.0\text{ V}$) module at room temperature ($T_A = 25\text{ }^\circ\text{C}$)

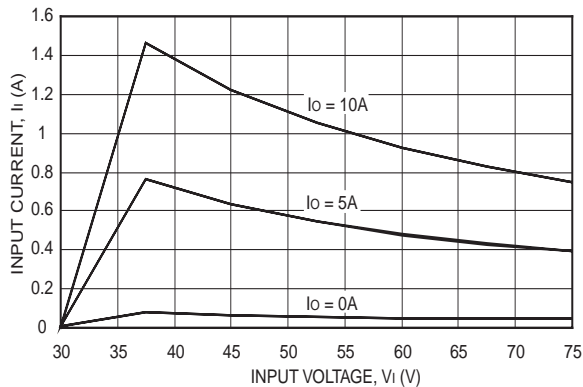

Figure 31. Input Voltage and Current Characteristics.

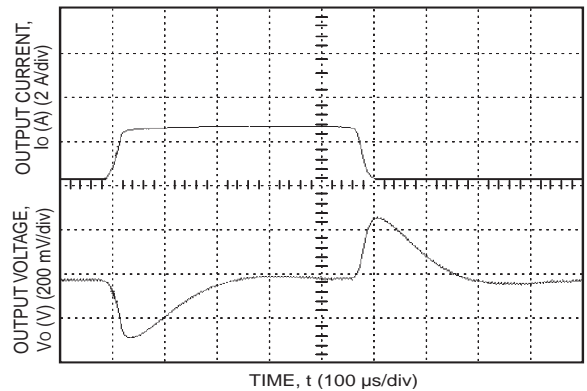

Figure 34. Transient Response to Step Decrease in Load from 50% to 25% of Full Load ($V_I = 48\text{ Vdc}$).

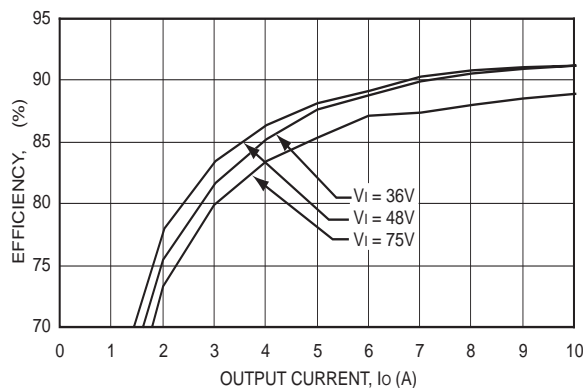

Figure 32. Converter Efficiency vs. Output Current.

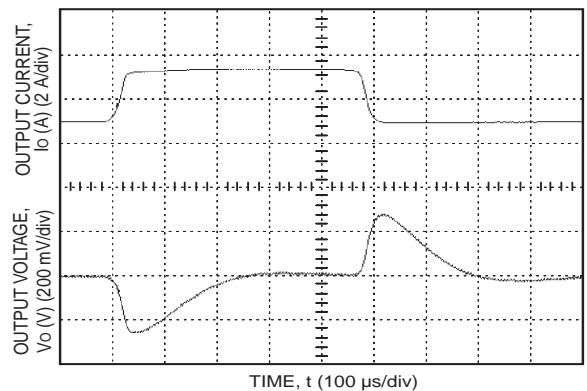

Figure 35. Transient Response to Step Increase in Load from 50% to 75% of Full Load ($V_I = 48\text{ Vdc}$).

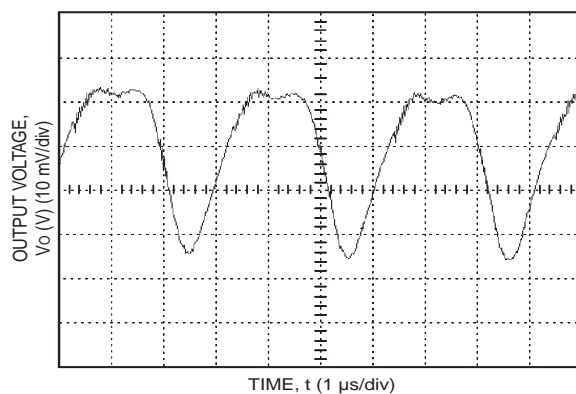

Figure 33. Output Ripple Voltage ($I_O = I_{O, \text{max}}$).

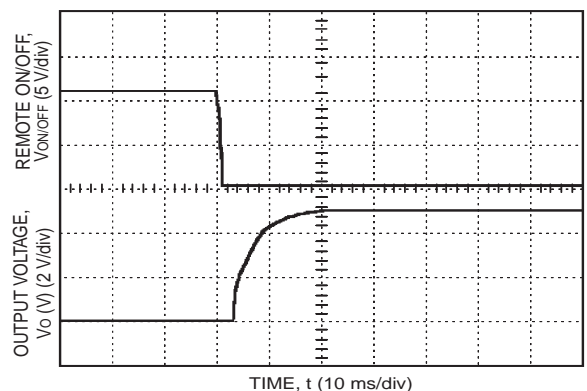
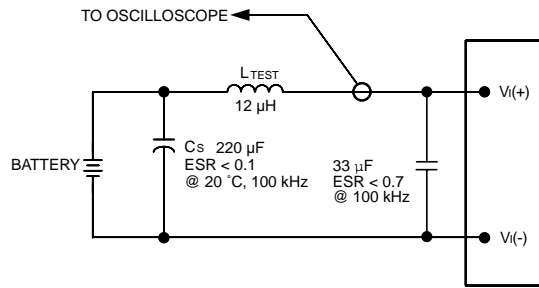

Figure 36. Start-up from Remote On/Off ($I_O = I_{O, \text{max}}$).

Test Configurations



Note: Measure input reflected ripple current with a simulated source inductance (L_{TEST}) of $12\mu\text{H}$. Capacitor C_S offsets possible battery impedance. Measure current as shown above.

Figure 37. Input Reflected Ripple Current Test Setup.

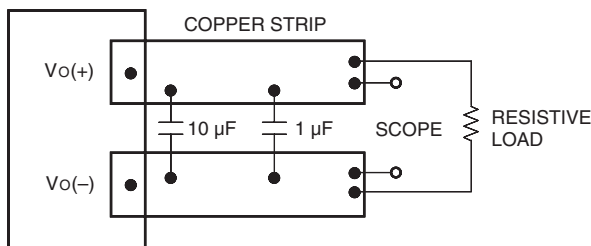

Note: Scope measurements should be made using a BNC socket, with a $10\mu\text{F}$ tantalum capacitor and a $1\mu\text{F}$ ceramic capacitor. Position the load between 51 mm and 76 mm (2 in and 3 in) from the module

Figure 38. Peak-to-Peak Output Ripple Measurement Test Setup.

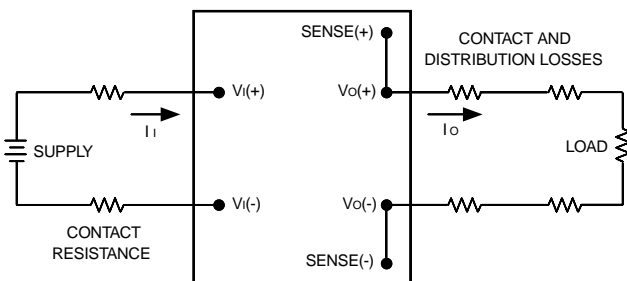

Note: All voltage measurements to be taken at the module terminals, as shown above. If sockets are used then Kelvin connections are required at the module terminals to avoid measurement errors due to socket contact resistance.

Figure 39. Output Voltage and Efficiency Test Setup.

$$\eta = \left(\frac{[V_{O(+)} - V_{O(-)}] \times I_O}{[V_{I(+)} - V_{I(-)}] \times I_I} \right) \times 100$$

Safety Considerations

For safety-agency approval of the system in which the power module is used, the power module must be installed in compliance with the spacing and separation requirements of the end-use safety agency standard, i.e., *UL60950*, *CSA C22.2 No. 60950-00*, and *VDE 0805:2001-12 (IEC60950, 3rd Ed)*.

These converters have been evaluated to the spacing requirements for Basic Insulation, per the above safety standards.

For Basic Insulation models ("B" Suffix), 1500 Vdc is applied from V_I to V_O to 100% of outgoing production.

For end products connected to -48 Vdc , or -60 Vdc nominal DC MAINS (i.e. central office dc battery plant), no further fault testing is required.

Note: -60 Vdc nominal battery plants are not available in the U.S. or Canada.

For all input voltages, other than DC MAINS, where the input voltage is less than 60 Vdc , if the input meets all of the requirements for SELV, then:

- 1 The output may be considered SELV. Output voltages will remain within SELV limits even with internally-generated non-SELV voltages. Single component failure and fault tests were performed in the power converters.
- 1 One pole of the input and one pole of the output are to be grounded, or both circuits are to be kept floating, to maintain the output voltage to ground voltage within ELV or SELV limits.

For all input sources, other than DC MAINS, where the input voltage is between 60 and 75 Vdc (Classified as TNV-2 in Europe), the following must be adhered to, if the converter's output is to be evaluated for SELV:

- 1 The input source is to be provided with reinforced insulation from any hazardous voltage, including the AC mains.
- 1 One V_I pin and one V_O pin are to be reliably earthed, or both the input and output pins are to be kept floating.
- 1 Another SELV reliability test is conducted on the whole system, as required by the safety agencies, on the combination of supply source and the subject module to verify that under a single fault, hazardous voltages do not appear at the module's output.

The power module has ELV (extra-low voltage) outputs when all inputs are ELV.

All flammable materials used in the manufacturing of these modules are rated 94V-0, and *UL60950A.2* for reduced thicknesses. The input to these units is to be provided with a maximum 5A time-delay in the unearthed lead.

Design Considerations

Input Source Impedance

The power module should be connected to a low ac-impedance input source. Highly inductive source impedances can affect the stability of the power module. If the input source inductance exceeds 4 μ H, a 33 μ F electrolytic capacitor (ESR < 0.7 Ω at 100 kHz) mounted close to the power module helps ensure stability of the unit.

Feature Descriptions

Remote On/Off

Two remote On/Off options are available. Positive logic remote On/Off turns the module on during a logic-high voltage on the remote ON/OFF pin, and off during a logic low. Negative logic remote On/Off, device code suffix "1", turns the module off during logic-high voltage and on during a logic low.

To turn the power module on and off, the user must supply a switch to control the voltage between the ON/OFF pin and the VI(-) terminal. The switch may be an open collector or equivalent (see Figure 40). A logic low is $V_{on/off} = -0.7$ V to 1.2 V. The maximum $I_{on/off}$ during a logic low is 1 mA. The switch should maintain a logic-low voltage while sinking 1 mA. During a logic high, the maximum $V_{on/off}$ generated by the power module is 15 V. The maximum allowable leakage current of the switch at $V_{on/off} = 15$ V is 50 μ A.

If not using the remote on/off feature, do one of the following:

For positive logic, leave the ON/OFF pin open.

For negative logic, short the ON/OFF pin to VI(-).

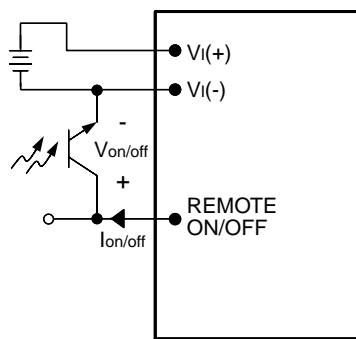

Figure 40. Remote On/Off Implementation.

Remote Sense

Remote sense minimizes the effects of distribution losses by regulating the voltage at the remote sense connections. The voltage between the remote sense pins and the output terminals must not exceed the output voltage sense range given in the Feature Specifications table:

$$[VO(+)-VO(-)]-[SENSE(+)-SENSE(-)] \leq 0.5 \text{ V}$$

The voltage between the VO(+) and VO(-) terminals must not

Tyco Electronics Power Systems

exceed the minimum output overvoltage protection value shown in the Feature Specifications table. This limit includes any increase in voltage due to remote sense compensation and output voltage set-point adjustment (trim) (See Figure 41). If not using the remote sense feature to regulate the output at the point of load, then connect SENSE(+) and SENSE(-) to VO(+) and VO(-) at the module.

Although the output voltage can be increased by both the remote sense and by the trim, the maximum increase for the output voltage is not the sum of both. The maximum increase is the larger of either the remote sense or the trim.

The amount of power delivered by the module is defined as the voltage at the output terminals multiplied by the output current. When using remote sense and trim, the output voltage of the module can be increased, which at the same output current would increase the power output of the module. Care should be taken to ensure that the maximum output power of the module remains at or below the maximum rated power.

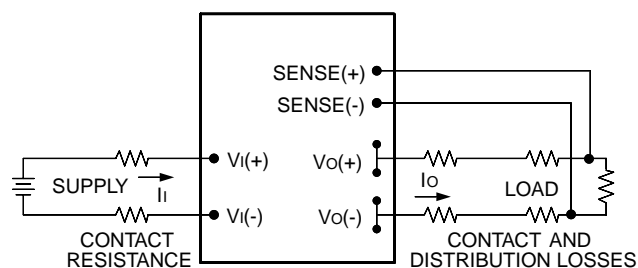

Figure 41. Effective Equivalent Circuit Configuration for Single-Module Remote-Sense Operation.

Output Voltage Set-Point Adjustment (Trim)

Output voltage trim allows the user to increase or decrease the output voltage set point of a module. This is accomplished by connecting an external resistor between the TRIM pin and either the SENSE(+) or SENSE(-) pins. The trim resistor should be positioned close to the module. If not using the trim feature, leave the TRIM pin open.

with an external resistor $R_{trim-down}$ between the TRIM and SENSE(-) pins, the output voltage set point VO , set decreases (see Figure 48). The following equation determines the required external-resistor value to trim-down the output voltage:

$$R_{trim-down} = \left\{ \frac{A}{F} - B \right\} k\Omega$$

$R_{trim-down}$ is the external resistor in $k\Omega$

$$F = \left| \frac{\Delta\%}{100} \right|$$

$\Delta\%$ is the percentage change in voltage

A and B values are defined in Table 1 for various models.

Feature Descriptions (continued)

Output Voltage Set-Point Adjustment (Trim) (continued)

Table 1

| Vo | A | B |
|-----|-------|--------|
| 5.0 | 5.11 | 45.31 |
| 3.3 | 5.11 | 45.31 |
| 2.5 | 5.11 | 45.31 |
| 1.8 | 3.248 | 18.645 |
| 1.5 | 2.312 | 17.711 |
| 1.2 | 2.315 | 17.711 |

For example, to trim-down the output voltage of 2.5 V module (QW020A0G) by 8% to 2.3 V, Rtrim-down is calculated as follows:

F = 0.08, A = 5.11, & B = 45.31

$$R_{\text{trim-down}} = \left\{ \frac{5.11}{0.08} - 45.31 \right\} \text{k}\Omega$$

$$R_{\text{trim-down}} = 18.565 \text{k}\Omega$$

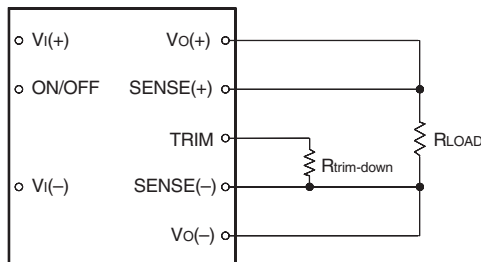

Figure 42. Circuit Configuration to Decrease Output Voltage.

The QW010/015/020 modules have a fixed current-limit set point. As the output voltage is trim-down, the available output power is reduced.

With an external resistor Rtrim-up, connected between the TRIM and SENSE(+) pins, the output voltage set point VO, set increases (see Figure 43). The following equation determines the required external-resistor value to trim-up and output voltage:

$$R_{\text{trim-up}} = \left\{ \frac{A}{F} - B \right\} \text{k}\Omega$$

Rtrim-up is the external resistor in kW

$$F = \left| \frac{\Delta\%}{100} \right|$$

Δ% is the percentage change in voltage

A and B values are defined in Table 2 for various models

Table 2

| Output Voltage (V) | A | B | C |
|--------------------|------|------|------|
| 1.2 | 15.9 | 1089 | 62.0 |
| 1.5 | 19.8 | 1089 | 104 |
| 1.8 | 23.8 | 1089 | 104 |
| 2.5 | 34.5 | 1690 | 73.1 |
| 3.3 | 45.5 | 1690 | 73.1 |
| 5.0 | 69.0 | 1690 | 73.1 |

For example, to trim-up the output voltage of 1.5 V module (QW020A0M) by 8% to 1.62 V, Rtrim-up is calculated as follows:

F = 0.08, A = 3.946, & B = 11.454

$$R_{\text{trim-up}} = \left\{ \frac{3.946}{0.08} - 11.454 \right\} \text{k}\Omega$$

$$R_{\text{trim-up}} = 37.871 \text{k}\Omega$$

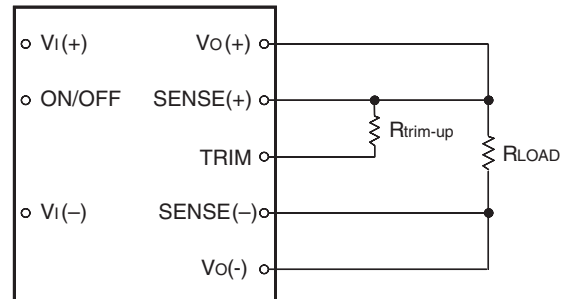

Figure 43. Circuit Configuration to Increase Output Voltage.

The voltage between the VO(+) and VO(-) terminals must not exceed the minimum output overvoltage protection value shown in the Feature Specifications table. This limit includes any increase in voltage due to remote-sense compensation and output voltage set-point adjustment trim.

Although the output voltage can be increased by both the remote sense and by the trim, the maximum increase for the output voltage is not the sum of both. The maximum increase is the larger of either the remote sense or the trim.

The amount of power delivered by the module is defined as the voltage at the output terminals multiplied by the output current. When using remote sense and trim, the output voltage of the module can be increased, which at the same output current would increase the power output of the module. Care should be taken to ensure that the maximum output power of the module remains at or below the maximum rated power.

Feature Descriptions (continued)

Overcurrent Protection

To provide protection in an output overload fault condition, the module is equipped with internal current-limiting circuitry, and can endure current limiting for an unlimited duration. At the instance of current-limit inception, the module enters a "hiccup" mode of operation, whereby it shuts down and automatically attempts to restart. While the fault condition exists, the module will remain in this mode until the fault is cleared. The unit operates normally once the output current is reduced back into its specified range.

Output Overvoltage Protection

The output overvoltage protection consists of circuitry that monitors the voltage of the output terminals. If the output voltage exceeds the overvoltage protection threshold, the module enters a "hiccup" mode of operation, whereby it shuts down and automatically attempts to restart. While the fault condition exists, the module will remain in this hiccup mode until the overvoltage fault is cleared.

Overtemperature Protection

The output overvoltage protection consists of circuitry that monitors the voltage on the output terminals. If the output voltage exceeds the overvoltage protection threshold, the module enters a "hiccup" mode of operation, whereby it shuts down and automatically attempts to restart. While the fault condition exists, the module will remain in this hiccup mode until the overvoltage fault is cleared.

Input Undervoltage Lockout

At input voltages below the input undervoltage lockout limit, the module operation is disabled. The module will begin to operate at an input voltage above the undervoltage lockout turn-on threshold.

Thermal Considerations

The power modules operate in a variety of thermal environments; however, sufficient cooling should be provided to help ensure reliable operation of the unit. Heat is removed by conduction, convection, and radiation to the surrounding environment. Proper cooling can be verified by measuring drain pin of Q560 or of Q10 at the position indicated in Figure 44.

The temperature at Q560 and Q10 drain pins should not exceed 110 °C. The output power of the module should not exceed the rated power for the module (VO, set x IO, max).

Although the maximum operating ambient temperature of the power modules is 85 °C, you can limit this temperature to a lower value for extremely high reliability.

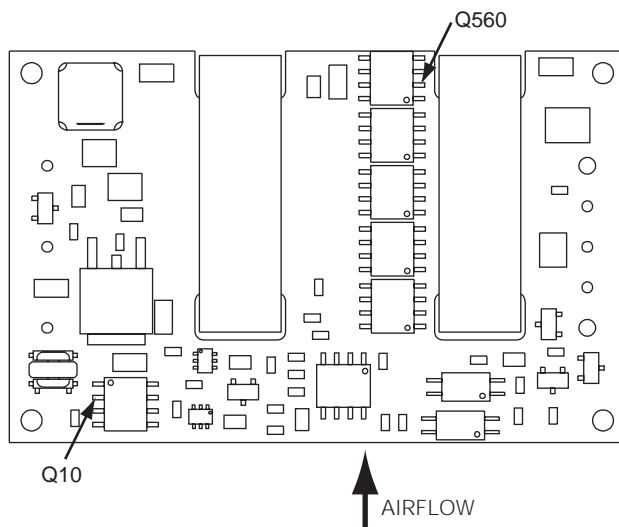

Figure 44. Temperature Measurement Location, QW015A0F (Top View).

Heat Transfer via Convection

Increasing airflow over the module enhances the heat transfer via convection. Figures 45—55 show the maximum current that can be delivered by various modules versus local ambient temperature (TA) for natural convection through 2 m/s (400 ft./min.).

Systems in which these power modules may be used typically generate natural convection airflow rates of 0.3 ms⁻¹ (60 ft./min.) due to other heat-dissipating components in the system. Therefore, the natural convection condition represents airflow rates of up to 0.3 ms⁻¹ (60 ft./min.).

Example

What is the minimum airflow necessary for a QW015A0F1 operating at VIN = 48 V, an output current of 12 A, and a maximum ambient temperature of 75 °C.

Solution

Given: VIN = 48V
IO = 12 A
TA = 75 °C

Tyco Electronics Power Systems

Determine airflow (v) (Use Figure 52)

$$v = 0.5 \text{ m/s (100 ft./min.)}$$

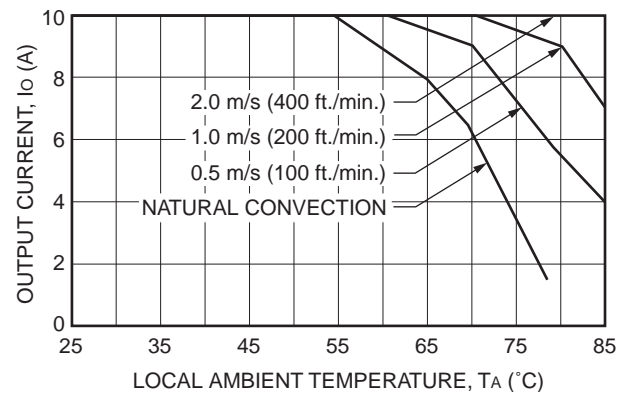

Figure 45. Derating Curves for QW010A0A1 (VO = 5.0V) in Longitudinal Orientation with no heat sink (VI = 48 Vdc).

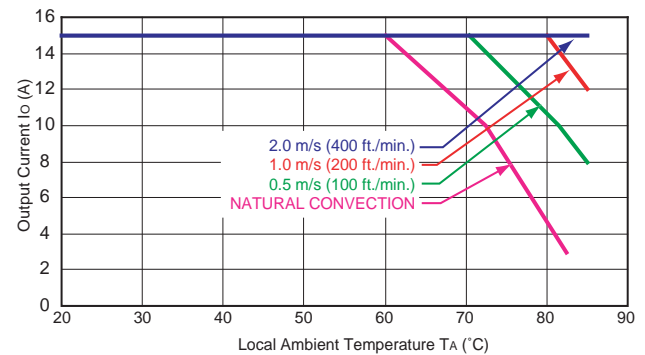

Figure 46. Derating Curves for QW010A0F1 (VO = 3.3V) in Longitudinal Orientation with no heat sink (VI = 48 Vdc).

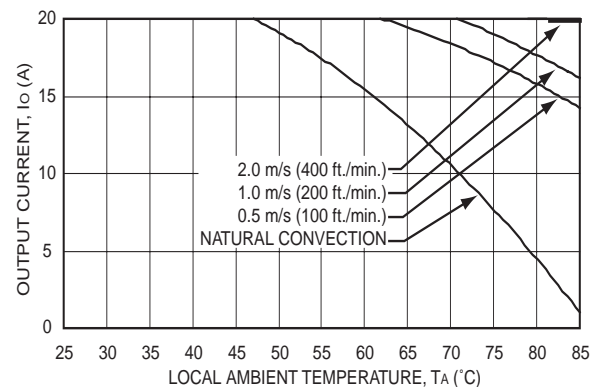

Figure 47. Derating Curves for QW010A0G1 (VO = 2.5V) in Longitudinal Orientation with no heat sink (VI = 48 Vdc).

Thermal Considerations (continued)

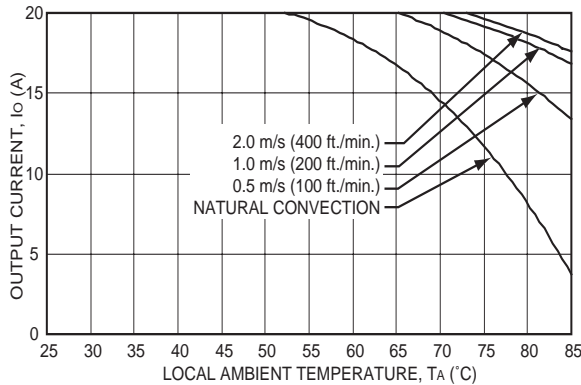

Figure 48. Derating Curves for QW010A0Y1 (VO = 1.8V) in Longitudinal Orientation with no heat sink (VI = 48 Vdc).

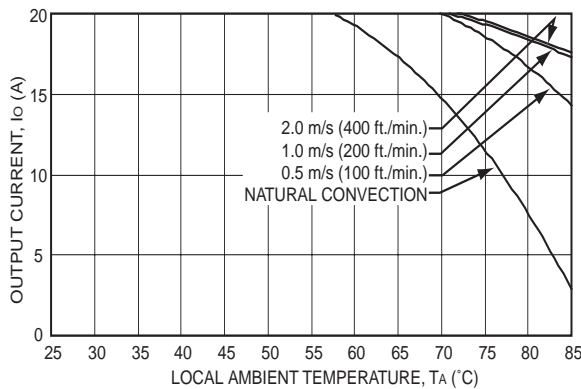

Figure 49. Derating Curves for QW010A0P1 (VO = 1.2V) in Longitudinal Orientation with no heat sink (VI = 48 Vdc).

Layout Considerations

Copper paths must not be routed beneath the power module. For additional layout guidelines, refer to the FLTR100V10 or FLTR100V20 data sheet.

Through-Hole Lead-Free Soldering Information

The RoHS-compliant through-hole products use the SAC (Sn/Ag/Cu) Pb-free solder and RoHS-compliant components. They are designed to be processed through single or dual wave soldering machines. The pins have an RoHS-compliant finish that is compatible with both Pb and Pb-free wave soldering processes. A maximum preheat rate of 3°C/s is suggested. The wave preheat process should be such that the temperature of the power module board is kept below 210°C. For Pb solder, the recommended pot temperature is 260°C, while the Pb-free solder pot is 270°C max. Not all RoHS-compliant through-hole products can be processed with paste-through-hole Pb or Pb-free reflow process. If additional information is needed, please consult with your Tyco Electronics Power System representative for more details.

Surface Mount Information

Pick and Place Area

Although the module weight is minimized by using open-frame construction, the modules have a relatively large mass compared to conventional surface-mount components. To optimize the pick-and-place process, automated vacuum equipment variables such as nozzle size, tip style, vacuum pressure, and placement speed should be considered. Surface-mount versions of this family have a flat surface which serves as a pick-and-place location for automated vacuum equipment. The module's pick-and-place location is identified in Figure 56.

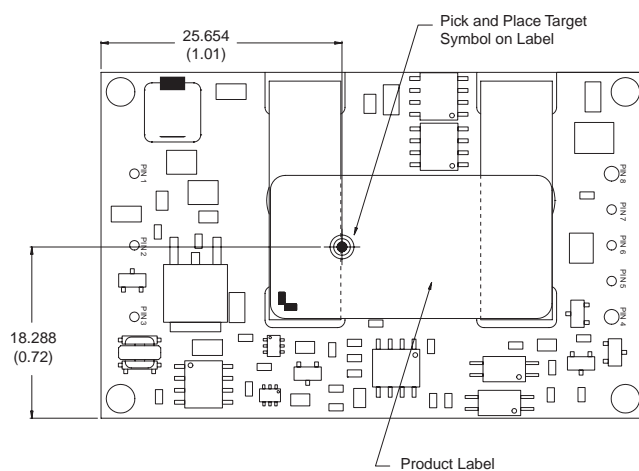

Figure 50. Pick and Place Location.

Reflow Soldering Information

The QW series of power modules is available for either Through-Hole (TH) or Surface Mount (SMT) soldering. These power modules are large mass, low thermal resistance devices and typically heat up slower than other SMT components. It is recommended that the customer review data Tyco Electronics Power Systems

sheets in order to customize the solder reflow profile for each application board assembly.

The following instructions must be observed when SMT soldering these units. Failure to observe these instructions may result in the failure of or cause damage to the modules, and can adversely affect long-term reliability.

Typically, the eutectic solder melts at 183°C, wets the land, and subsequently wicks the device connection. Sufficient time must be allowed to fuse the plating on the connection to ensure a reliable solder joint. There are several types of SMT reflow technologies currently used in the industry.

These surface mount power modules can be reliably soldered using natural forced convection, IR (radiant infrared), or a combination of convection/IR.

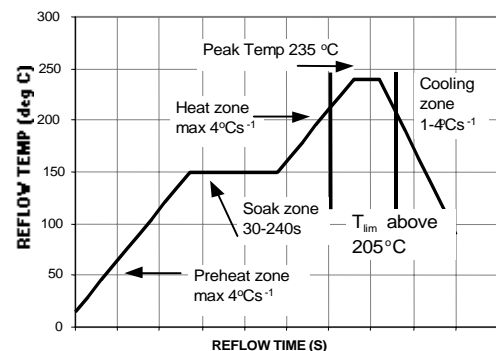

Figure 51. Recommended Reflow profile.

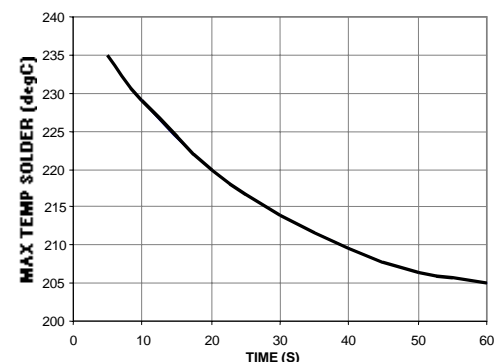

Figure 52. Time Limit curve above 205°C.

Lead Free Soldering

The -Z version SMT modules of the QW series are lead-free (Pb-free) and RoHS compliant and are compatible in a Pb-free soldering process. Failure to observe the instructions below may result in the failure of or cause damage to the modules and can adversely affect long-term reliability.

Pb-free Reflow Profile

Power Systems will comply with J-STD-020 Rev. C (Moisture/Reflow Sensitivity Classification for Nonhermetic Solid State Surface Mount Devices) for both Pb-free solder profiles and MSL classification procedures. This standard provides a recommended forced-air-convection reflow profile based on the volume and thickness of the package (table 4-2). The suggested Pb-free solder paste is Sn/Ag/Cu (SAC). The recommended linear reflow profile using Sn/Ag/Cu solder is shown in Figure. 59.

Surface Mount Information (continued)

MSL Rating

The QW series SMT modules have a MSL rating of 2.

Storage and Handling

The recommended storage environment and handling procedures for moisture-sensitive surface mount packages is detailed in J-STD-033 Rev. A (Handling, Packing, Shipping and Use of Moisture/Reflow Sensitive Surface Mount Devices). Moisture barrier bags (MBB) with desiccant are required for MSL ratings of 2 or greater. These sealed packages should not be broken until time of use. Once the original package is broken, the floor life of the product at conditions of $\leq 30^{\circ}\text{C}$ and 60% relative humidity varies according to the MSL rating (see J-STD-033A). The shelf life for dry packed SMT packages will be a minimum of 12 months from the bag seal date, when stored at the following conditions: $< 40^{\circ}\text{C}$, $< 90\%$ relative humidity.

Post Solder Cleaning and Drying Considerations

Post solder cleaning is usually the final circuit-board assembly process prior to electrical board testing. The result of inadequate cleaning and drying can affect both the reliability of a power module and the testability of the finished circuit-board assembly. For guidance on appropriate soldering, cleaning and drying procedures, refer to Tyco Electronics *Board Mounted Power Modules: Soldering and Cleaning* Application Note (AP01-056EPS).

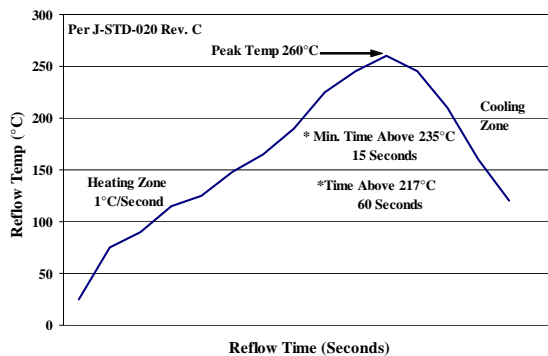

Figure 53. Recommended linear reflow profile using Sn/Ag/Cu solder.

Solder Ball and Cleanliness Requirements

The open frame (no case or potting) power module will meet the solder ball requirements per J-STD-001B. These requirements state that solder balls must neither be loose nor violate the power module minimum electrical spacing.

The cleanliness designator of the open frame power module is C00 (per J specification).

Outline Diagram for Surface-Mount Module

Dimensions are in millimeters and (inches).

Tolerances: x.x mm \pm 0.5 mm (x.xx in. \pm 0.02 in.) [unless otherwise indicated]
x.xx mm \pm 0.25 mm (x.xxx in. \pm 0.010 in.)

TOP VIEW

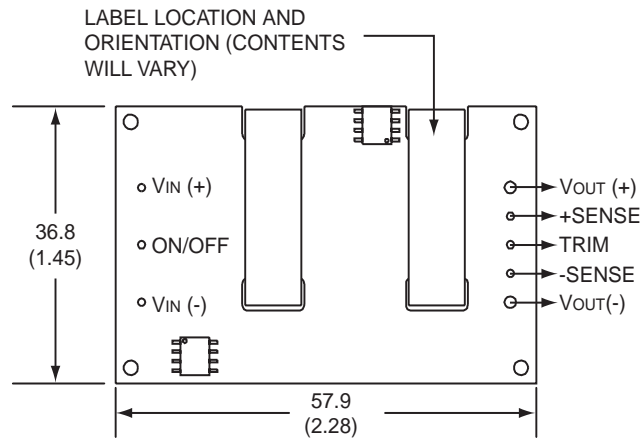

SIDE VIEW

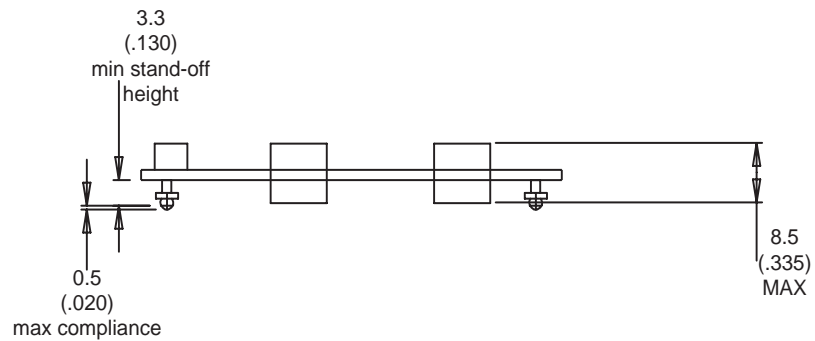

BOTTOM VIEW

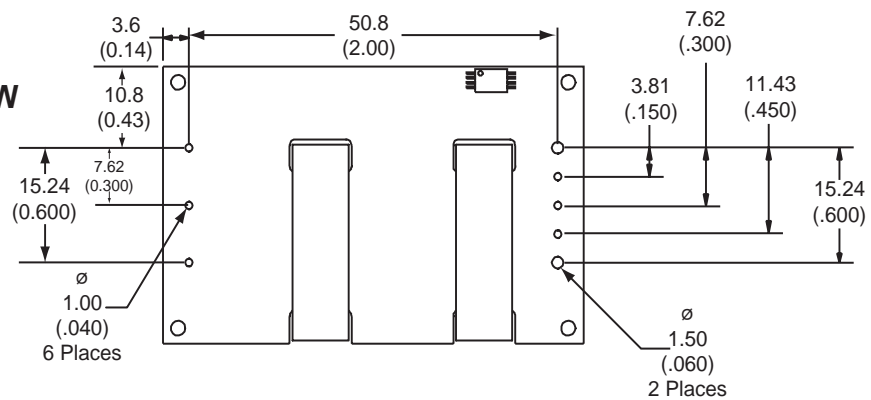

Outline Diagram for Through-Hole Module

Dimensions are in millimeters and (inches).

Tolerances: x.x mm ± 0.5 mm (x.xx in. ± 0.02 in.) [unless otherwise indicated]
x.xx mm ± 0.25 mm (x.xxx in. ± 0.010 in.)

TOP VIEW

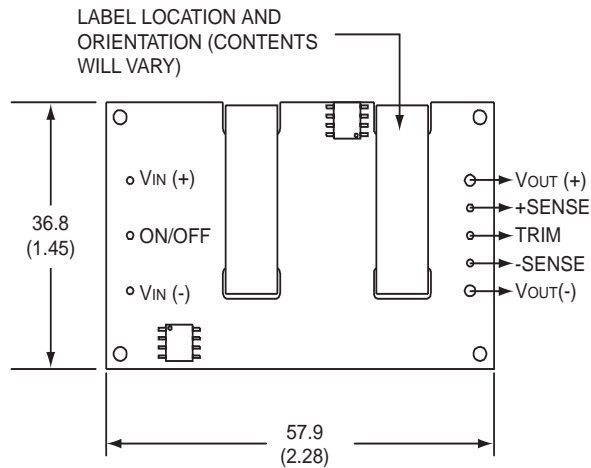

SIDE VIEW

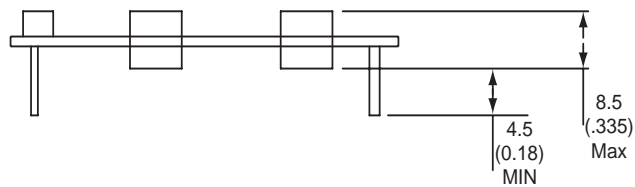

BOTTOM VIEW

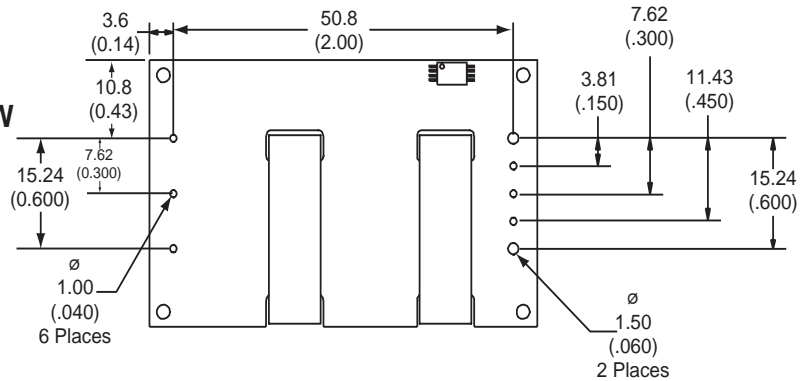

Recommended Pad Layout for Surface-Mount Module and Recommended Hole Layout for Through-Hole Module

Component-side footprint.

Dimensions are in millimeters and (inches), unless otherwise noted.

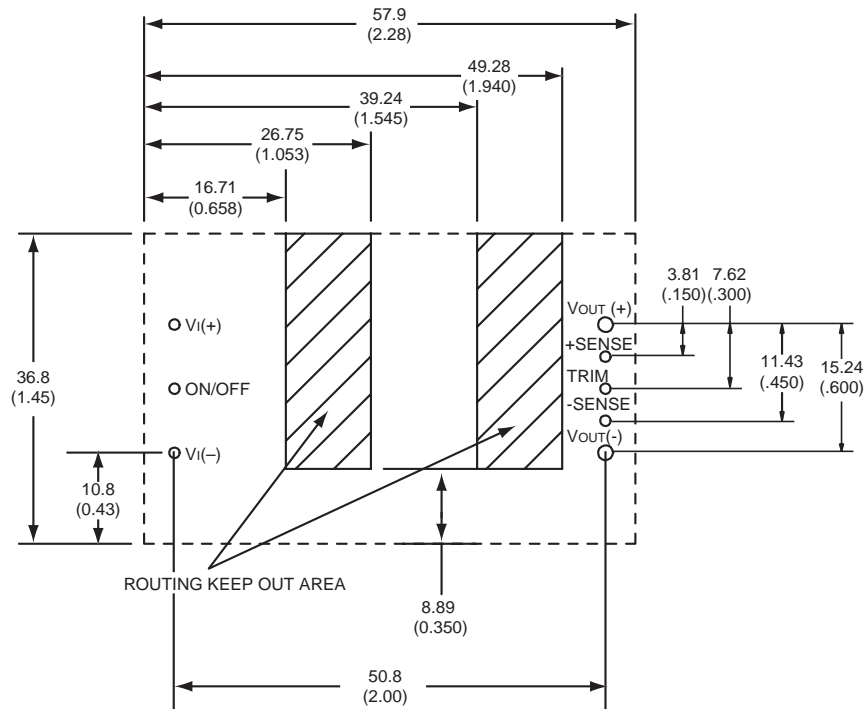

NOTES:

- FOR CGA SURFACE MOUNT PIN
USE THE FOLLOWING PAD

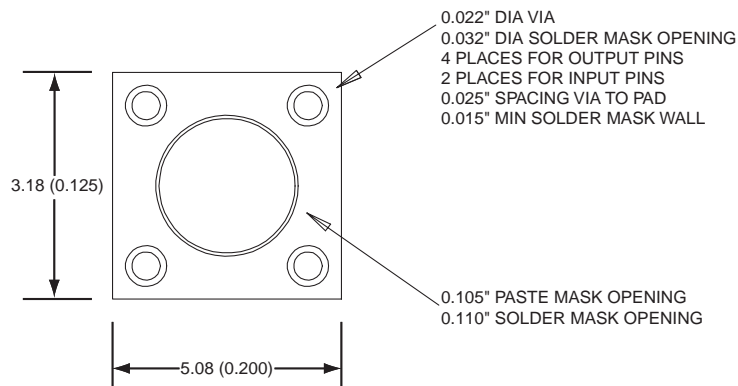

Ordering Information

Please contact your Tyco Electronics' Sales Representative for pricing, availability and optional features.

Table 1. Device Codes

| Input Voltage | Output Voltage | Output Current | Efficiency | Connector Type | Device Code | Comcodes |
|---------------|----------------|----------------|------------|----------------|--------------|-------------|
| 36 – 75 Vdc | 1.2 V | 20 A | 85% | Through-hole | QW020A0P1 | 108968447 |
| 36 – 75 Vdc | 1.5 V | 20 A | 87% | Through-hole | QW020A0M | 108976036 |
| 36 – 75 Vdc | 1.5 V | 20 A | 87% | Through-hole | QW020A0M1 | 108970708 |
| 36 – 75 Vdc | 1.8 V | 20 A | 89% | Through-hole | QW020A0Y1 | 108967522 |
| 36 – 75 Vdc | 2.5 V | 20 A | 90% | Through-hole | QW020A0G | 108974783 |
| 36 – 75 Vdc | 2.5 V | 20 A | 90% | Through-hole | QW020A0G1 | 108969296 |
| 36 – 75 Vdc | 3.3 V | 15 A | 91% | Through-hole | QW015A0F | 108971797 |
| 36 – 75 Vdc | 3.3 V | 15 A | 91% | Through-hole | QW015A0F1 | 108966508 |
| 36 – 75 Vdc | 5.0 V | 10 A | 92% | Through-hole | QW010A0A | 108981226 |
| 36 – 75 Vdc | 5.0 V | 10 A | 92% | Through-hole | QW010A0A1 | 108969585 |
| 36 – 75 Vdc | 1.2 V | 20 A | 85% | SMT | QW020A0P-S | 108968488 |
| 36 – 75 Vdc | 1.2 V | 20 A | 85% | SMT | QW020A0P1-S | 108971961 |
| 36 – 75 Vdc | 1.2 V | 20 A | 85% | Through-hole | QW020A0P1Z | CC109107281 |
| 36 – 75 Vdc | 1.5 V | 20 A | 87% | Through-hole | QW020A0M1Z | CC109107273 |
| 36 – 75 Vdc | 1.8 V | 20 A | 89% | Through-hole | QW020A0Y1Z | CC109102968 |
| 36 – 75 Vdc | 2.5 V | 20 A | 90% | Through-hole | QW020A0G1Z | CC109101490 |
| 36 – 75 Vdc | 2.5 V | 20 A | 90% | Through-hole | QW020A0GZ | CC109107265 |
| 36 – 75 Vdc | 3.3 V | 15 A | 91% | Through-hole | QW015A0FZ | CC109103280 |
| 36 – 75 Vdc | 3.3 V | 15 A | 91% | Through-hole | QW015A0F1Z | CC109107240 |
| 36 – 75 Vdc | 5.0 V | 10 A | 92% | Through-hole | QW010A0A1Z | CC109107232 |
| 36 – 75 Vdc | 3.3 V | 15 A | 91% | SMT | QW015A0F1-SZ | 109100427 |
| 36 – 75 Vdc | 5.0 V | 10 A | 92% | SMT | QW010A0A1-SZ | 109100410 |

Ordering Information (continued)

Optional features can be ordered using the suffixes shown below. The suffixes follow the last letter of the Product Code and are placed in descending alphanumerical order.

Table 2. Device Options

| Option | Suffix |
|--|--------|
| Negative remote on/off logic | 1 |
| Approved for Basic Insulation | -B |
| Surface mount interconnections | -S |
| Baseplate version for Heatsink attachment (Through-hole version only) | -H |
| RoHS Compliant | -Z |



World Wide Headquarters
Tyco Electronics Power Systems, Inc.
3000 Skyline Drive, Mesquite, TX 75149, USA
+1-800-526-7819 FAX: +1-888-315-5182
(Outside U.S.A.: **+1-972-284-2626**, FAX: +1-972-284-2900)
www.power.tycoelectronics.com
e-mail: techsupport1@tycoelectronics.com

Europe, Middle-East and Africa Headquarters
Tyco Electronics (UK) Ltd
Tel: +44 (0) 1344 469 300, Fax: +44 (0) 1344 469 301

Central America-Latin America Headquarters
Tyco Electronics Power Systems
Tel: +54 11 4316 2866, Fax: +54 11 4312 9508

Asia-Pacific Headquarters
Tyco Electronics Singapore Pte Ltd
Tel: +65 482 0311, Fax: 65 480 9299

Tyco Electronics Corporation reserves the right to make changes to the product(s) or information contained herein without notice. No liability is assumed as a result of their use or application. No rights under any patent accompany the sale of any such product(s) or information.

© 2001 Tyco Electronics Power Systems, Inc. (Mesquite, Texas) All International Rights Reserved.
Printed in U.S.A.

Document Name: DS06-008 ver.1.3
PDF Name: QW010-015-020_ds.pdf