



FEATURES

- Standard 2" x 2" packages/pinouts
- Output voltages/currents:
 - 3.3 Volts @ 8/9 Amps
 - 5 Volts @ 7/8 Amps
- Choice of 3 input voltage ranges: 10-18V, 18-36V, 36-75V
- Fully synchronous forward topology
- Outstanding performance:
 - ±1% setpoint accuracy
 - Efficiencies to 90%
 - Noise as low as 75mVp-p
 - Stable no-load operation
- On/off control and V_{OUT} trim pins
- Fully isolated (1500Vdc); I/O protected
- Thermal shutdown
- Designed to meet UL/EN/IEC60950-1 certification; CE marked

PRODUCT OVERVIEW

The newest products in DATEL's flagship A-Series are the UWR, 26-40 Watt isolated singles. Housed in standard 2" x 2" metal packages (which have traditionally carried 15-20 Watt devices), these power converters supply up to 9 Amps @ 3.3V or 8 Amps at 5V. They exemplify DATEL's relentless drive to bring designers more power/current, in standard packages/pinouts, without compromising reliability or resorting to thermal specmanship. Input voltage ranges are 10-18V ("D12" models), 18-36V ("D24" models) or 36-75V ("D48" models).

Employing an advanced, fully synchronous, high-frequency (300-360kHz) forward topology, UWR 26-40W singles attain 88-90% efficiencies enabling full-power operation to ambient temperatures as high as +55°C without supplemental air flow. Assembled using fully automated, SMT-on-pcb techniques, these DC/DC's additionally provide low noise (75mVp-p), high accuracy (±1%), tight line/load regulation (±0.5%), quick step response (200µsec), and stable no-load operation.

All models feature input pi filters, input undervoltage and overvoltage shutdown, output overvoltage protection, current limiting, short-circuit protection, and thermal shutdown. Each model has a V_{OUT} trim pin as well as an on/off control function that may be ordered with either positive or negative polarity. These devices are fully isolated (1500Vdc) and satisfy UL/EN/IEC60950-1 safety requirements. "D48" models (36-75V inputs) are CE marked.

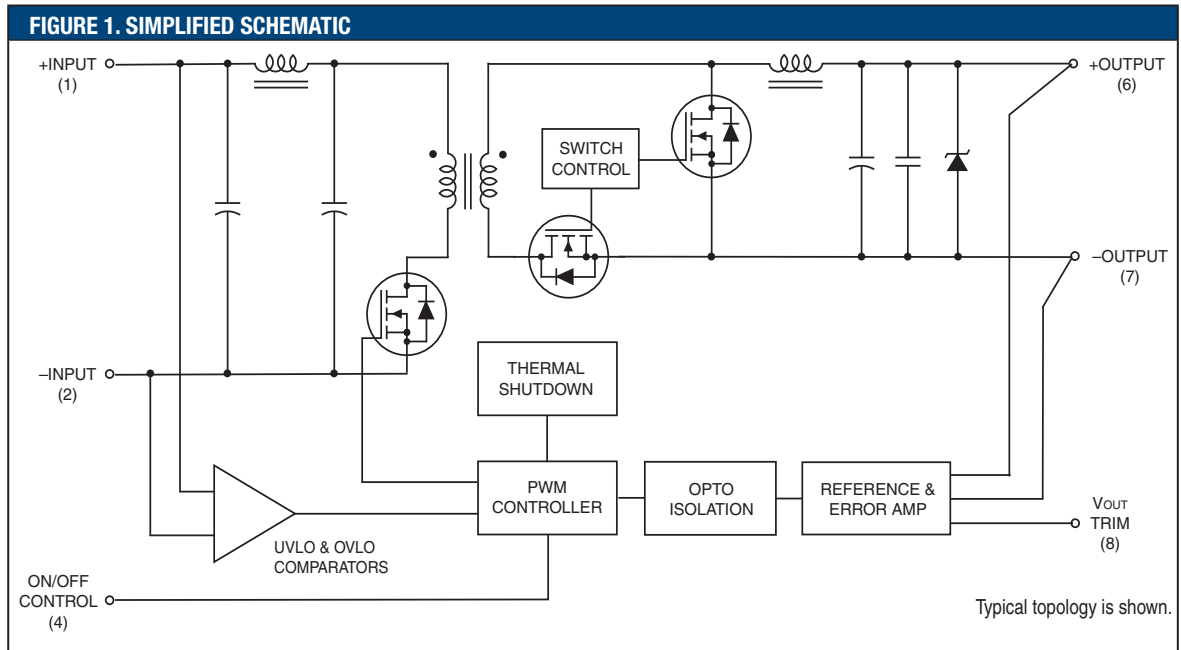

For full details go to
www.murata-ps.com/rohs

Performance Specifications and Ordering Guide^①

Model ^⑤	Output				Input			Efficiency		Package (Case, Pinout)		
	V _{OUT} (Volts)	I _{OUT} (Amps)	R/N (mVp-p) ^②		Regulation (Max.)		V _{IN} Nom. (Volts)	Range (Volts)	I _{IN} ^④ (mA/A)		Min.	Typ.
			Typ.	Max.	Line	Load ^③						
UWR-3.3/8-D12A-C	3.3	8	75	110	±0.05%	±0.5%	12	10-18	145/2.97	88%	89%	C4, P6
UWR-3.3/9-D24A-C	3.3	9	75	110	±0.5%	±0.5%	24	18-36	50/1.4	86%	88.5%	C4, P6
UWR-3.3/9-D48AN-C	3.3	9	75	110	±0.5%	±0.5%	48	36-75	25/0.7	86%	88.5%	C4, P6
UWR-5/7-D12A-C	5	7	75	110	±0.5%	±0.5%	12	10-18	160/3.26	85.5%	89.5%	C4, P6
UWR-5/8-D24A-C	5	8	75	110	±0.05%	±0.15%	24	18-36	90/1.82	90%	91.5%	C4, P6
UWR-5/8-D48AN-C	5	8	75	110	±0.5%	±0.5%	48	36-75	25/0.93	86%	90%	C4, P6

- ① Typical at TA = +25°C under nominal line voltage and full-load conditions, unless noted.
- ② Ripple/Noise (R/N) is tested/specified over a 20MHz bandwidth. All models are specified with an external 0.47µF multi-layer ceramic capacitor installed across their output pins. Using a 10µF multi-layer ceramic capacitor instead (e.g. TDK part no. C3225X5R1C106M) will further reduce the R/N to 35mVp-p typical and 75mVp-p maximum.
- ③ Load regulation is specified over 0-100% load conditions. All models are stable and regulate within spec under no-load conditions, with perhaps a slight increase in output ripple/noise.
- ④ Nominal line voltage, no-load/full-load conditions.
- ⑤ Please refer to the part number structure when ordering.

PART NUMBER STRUCTURE

UWR-3.3/9-D48AN-C

Output Configuration:
U = Unipolar

Wide Range Input

Nominal Output Voltage:
3.3 or 5 Volts

Maximum Output Current
in Amps

RoHS-6 hazardous substance compliant

On/Off Polarity, see below

A-Series
High Reliability

Input Voltage Range:
D12 = 10-18 Volts (12V nominal)
D24 = 18-36 Volts (24V nominal)
D48 = 36-75 Volts (48V nominal)

Part Number Suffixes

UWR 26-40W DC/DC's are designed so the On/Off Control function on pin 4 can be ordered with either positive (open or "high" = on) or negative (open = off, pull low = on) polarity. The standard part number with no suffix denotes positive polarity. Add an "N" suffix to select negative polarity.

No Suffix On/Off Control function (positive polarity) on pin 4. Standard for D12, D24.

"N" Suffix On/Off Control function (negative polarity) on pin 4. Standard for D48.

I/O Connections	
Pin	Function P6
1	+Input
2	-Input
3	No Pin
4	On/Off Control
5	No Pin
6	+Output
7	-Output
8	Trim

Note

For D12A and D24A models, the case is connected to Pin 2 (-Input).

For D48A models, the case is connected to Pin 1 (+Input).

MECHANICAL SPECIFICATIONS

Case C4

METAL CASE

INSULATED BASE

0.040 ± 0.002 DIA. (1.02 ± 0.05)

0.10 (2.5)

1.800 (45.72)

0.20 MIN (5.1)

0.45 (11.4)

2.00 (50.8)

0.200 (5.08)

0.400 (10.16)

0.100 (2.54)

5

6

7

8

1.200 (30.48)

3 EQ. SP. @ 0.400 (10.16)

2.00 (50.8)

0.40 (10.2)

BOTTOM VIEW

Dimensions are in inches (mm shown for ref. only).

Third Angle Projection

Tolerances (unless otherwise specified):
 .XX ± 0.02 (0.5)
 .XXX ± 0.010 (0.25)
 Angles = 2°

Components are shown for reference only.

Performance/Functional Specifications

 Typical @ T_A = +25°C under nominal line voltage and full-load conditions, unless noted. ① ②

Input	
Input Voltage Range:	
D12 Models	10-18 Volts (12V nominal)
D24 Models	18-36 Volts (24V nominal)
D48 Models	36-75 Volts (48V nominal)
Overvoltage Shutdown:	
D12 Models	19-23 Volts (21V typical)
D24 Models	37-43 Volts (40V typical)
D48 Models	76.5-82 Volts (78V typical)
Start-Up Threshold: ③	
D12 Models	8.5-10 Volts (9V typical)
D24 Models	16-18 Volts (17V typical)
D48 Models	33.5-36 Volts (35V typical)
Undervoltage Shutdown: ③	
D12 Models	7.5-9 Volts (8V typical)
D24 Models	15-17 Volts (16V typical)
D48 Models	31-33.5 Volts (32V typical)
Input Current:	
Normal Operating Conditions	See Ordering Guide
Standby Mode (Off, OV, UV)	5mA
Input Reflected Ripple Current	250mA _{p-p}
Input Filter Type	
D12 Models	Capacitive (13.2μF)
D24 Models	Pi (0.01μF-1μH-6.6μF)
D48 Models	Pi (0.01μF-2.2μH-2μF)
Reverse-Polarity Protection	Brief duration, 5A maximum
On/Off Control: ④ ⑤	
	On = open or 13V - +V _{IN} , I _{IN} = 1.6mA max.
	Off = 0-0.8V, I _{IN} = 2.6mA max.
"N" Models	On = 0-0.8V, I _{IN} = 1mA max.
	Off = open or 3.3-+V _{IN} , I _{IN} = 1mA max.
Output	
V_{OUT} Accuracy (50% load):	±1.0%, maximum
Minimum Loading for Specification: ②	10% of I _{OUT} maximum
Minimum Loading for Stability: ⑦	No load
Ripple/Noise (20MHz BW) ① ⑥	See Ordering Guide
Line/Load Regulation	See Ordering Guide
Efficiency	See Ordering Guide
Trim Range ②	±5%
Isolation Voltage:	
Input-to-Output	1500Vdc minimum
Output to Case	1500Vdc minimum
Isolation Capacitance	470pF
Isolation Resistance	100MΩ
Current Limit Inception (@98%V _{OUT}):	
3.3V _{OUT} Models	10.5-11.5 Amps
5V _{OUT} Models	8.5-9.5 Amps
Short Circuit Current: (Average)	
3.3V _{OUT} Models	3 Amps maximum
5V _{OUT} Models	4 Amps maximum
Overvoltage Protection:	Output voltage comparator
3.3V _{OUT} Models	3.7-4.1 Volts
5V _{OUT} Models	5.6-7.1 Volts
Temperature Coefficient	±0.02% per °C.

Dynamic Characteristics	
Dynamic Load Response: (50-100% load step to 1% V _{OUT})	200μsec maximum
Start-Up Time:	
V _{IN} to V _{OUT}	10ms
On/Off to V _{OUT}	10ms
Switching Frequency:	
UWR-3.3/8-D12A	360kHz (±36kHz)
UWR-3.3/9-D24A, -D48A	300kHz (±30kHz)
UWR-5/7-D12A	360kHz (±36kHz)
UWR-5/8-D24A, -D48A	310kHz (±30kHz)
Environmental	
MTBF ⑥	Bellcore, ground fixed, full power 25°C ambient
UWR-5/8-D24A	1.6 million hours
Operating Temperature ②	-40 to +85°C, with derating
Thermal Shutdown	+110°C case
Storage Temperature	-40 to +120°C
Flammability	UL94V-0
Physical	
Dimensions	See mechanical specifications
Case Material	Corrosion resistant steel with non-conductive, epoxy-based, black enamel finish and plastic baseplate
Pin Material	RoHS: Gold plate over copper alloy Non-RoHS: Pure tin over copper alloy
Weight:	2.7 ounces (76.5 grams)
Primary to Secondary Insulation Level	Functional (D12, D24 models) Basic (D48 models)

① All models are specified with external 0.47μF ceramic output capacitor.

② See Technical Notes/Graphs for details.

③ Applying a voltage to On/Off Control (pin 4) when no input power is applied to the converter can cause permanent damage.

 ④ Output noise may be further reduced with the addition of additional external output capacitors. See Technical Notes. Use only as much output filtering as needed *and no more*. Larger caps (especially low-ESR ceramic types) may slow transient response or degrade dynamic performance.

⑤ The On/Off Control is designed to be driven with open-collector logic or the application of appropriate voltage levels. Voltages may be referenced to the -Input (pin 2).

⑥ Demonstrated MTBF available on request.

Absolute Maximum Ratings	
Input Voltage:	
Continuous:	
D12A Models	18 Volts
D24A Models	36 Volts
D48A Models	75 Volts
Transient (100msec):	
D12A Models	25 Volts
D24A Models	50 Volts
D48A Models	100 Volts
On/Off Control (pin 4) Max. Voltages	
Referenced to -Input (pin 2)	
No Suffix	+V _{IN}
"N" Suffix	+V _{IN}
Input Reverse-Polarity Protection	
	Current must be <5 Amps. Brief duration only. Fusing recommended.
Output Current	
	Current limited. Devices can withstand sustained output short circuits without damage.
Case Temperature	
	+100°C
Storage Temperature	
	-40 to +120°C
Lead Temperature	
	See soldering guidelines
<p>These are stress ratings. Exposure of devices to greater than any of these conditions may adversely affect long-term reliability. Proper operation under conditions other than those listed in the Performance/Functional Specifications Table is not implied.</p>	

Input Fusing

Certain applications and/or safety agencies may require the installation of fuses at the inputs of power conversion components. Fuses should also be used if the possibility of sustained, non-current-limited, input-voltage polarity reversals exists. For DATEL A-Series UWR 26-40 Watt DC/DC Converters, you should use slow-blow type fuses with values no greater than the following.

Model	Fuse Value
UWR-3.3/8-D12	7 Amps
UWR-3.3/9-D24	4 Amps
UWR-3.3/9-D48	2 Amps
UWR-5/7-D12	8 Amps
UWR-5/8-D24	5 Amps
UWR-5/8-D48	3 Amps

Start-Up and Undervoltage Shutdown

Under normal start-up conditions, UWR 26-40W converters will not begin to regulate properly until the ramping input voltage exceeds the Start-Up Threshold. Once operating, devices will turn off when the applied voltage droops below the Undervoltage Shutdown point. Devices will remain off as long as the undervoltage condition continues. Units will automatically restart when the applied voltage is brought back above the Start-Up Threshold.. The hysteresis is built into the function avoids an indeterminate on/off condition at a single input voltage. See Performance/Functional Specifications table for actual limits.

On/Off Control

The input-side, remote On/Off Control function (pin 4) can be ordered to operate with either polarity. Positive-polarity devices (standard, no part-number suffix) are enabled when pin 4 is left open or is pulled high (+13V to V_{IN} applied with respect to -Input, pin 2, (see Figure 2). Positive-polarity devices are disabled when pin 4 is pulled low (0-0.8V with respect to -Input). Negative-polarity devices are off when pin 4 open or pulled high (3.3V to +V_{IN}), and on when pin 4 is pulled low (0-0.8V). See Figure 3.

TECHNICAL NOTES

Floating Outputs

Since these are isolated DC/DC converters, their outputs are "floating," with respect to the input. Designers will normally use the -Output (pin 7) as the ground/return of the load circuit. You can, however, use the +Output (pin 6) as ground/return to effectively reverse the output polarity.

Minimum Output Loading Requirements

UWR 26-40 Watt converters employ a synchronous-rectifier design topology. All models regulate within spec and are stable under no-load conditions.

Filtering and Noise Reduction

All UWR 26-40 Watt DC/DC Converters achieve their rated ripple and noise specifications using the external output capacitor specified in the Performance/Functional Specifications table. In critical applications, input/output noise may be further reduced by installing additional external I/O caps. Input capacitors should be selected for bulk capacitance, low ESR and high rms-ripple-current ratings. Input capacitors serve as energy-storage devices to minimize variations in line voltage caused by transient IR drops in PCB conductors from backplane to the DC/DC. Output capacitors should be selected for low ESR and appropriate frequency response. All caps should have appropriate voltage ratings and be mounted as close to the converters as possible. The most effective combination of external I/O capacitors will be a function of your particular load and layout conditions.

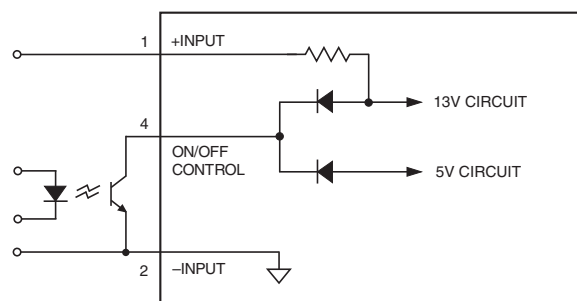

Figure 2. Driving the Positive Polarity On/Off Control Pin

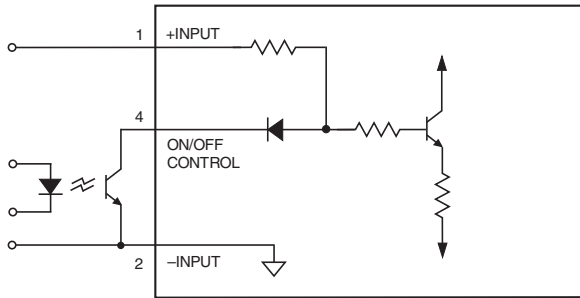

Figure 3. Driving the Negative Polarity On/Off Control Pin

Dynamic control of the remote on/off function is best accomplished with a mechanical relay or an open-collector/open-drain drive circuit (optically isolated if appropriate). The drive circuit should be able to sink appropriate current (see Performance Specs) when activated and withstand appropriate voltage when deactivated.

Applying an external voltage to pin 4 when no input power is applied to the converter can cause permanent damage to the converter.

Start-Up Time

The V_{IN} to V_{OUT} start-up time is the interval of time where the input voltage crosses the turn-on threshold point, and the fully loaded output voltage enters and remains within its specified accuracy band. Actual measured times will vary with input source impedance, external input/output capacitance, and load. The UWR 26-40 Watt implements a soft start circuit that limits the duty cycle of the PWM controller at power up, thereby limiting the Input Inrush current.

The On/Off Control to V_{OUT} start-up time assumes the converter has its nominal input voltage applied but is turned off via the On/Off Control pin. The specification defines the interval between the time at which the converter is turned on and the fully loaded output voltage enters and remains within its specified accuracy band. Similar to the V_{IN} to V_{OUT} start-up, the On/Off Control to V_{OUT} start-up time is also governed by the internal soft start circuitry and external load capacitance.

Input Overvoltage/Undervoltage Shutdown and Start-Up Threshold

Under normal start-up conditions, devices will not begin to regulate until the ramping-up input voltage exceeds the Start-Up Threshold Voltage (35V for "D48" models). Once operating, devices will not turn off until the input voltage drops below the Undervoltage Shutdown limit (34V for "D48" models). Subsequent re-start will not occur until the input is brought back up to the Start-Up Threshold. This built in hysteresis prevents any unstable on/off situations from occurring at a single input voltage.

Input voltages exceeding the input overvoltage shutdown specification listed in the Performance/Functional Specifications will cause the device to shutdown. A built-in hysteresis of 0.6 to 1.6 Volts for all models will not allow the converter to restart until the input voltage is sufficiently reduced.

Current Limiting

When output power increases above the rated output current, (see Current Limit in Performance/Functional Specifications) the DC/DC converter will go into a current limiting mode. In this condition the output voltage will decrease proportionately with increases in output current, thereby maintaining a somewhat constant power dissipation. This is commonly referred to as power limiting. Current limit inception is defined as the point where the full-power output voltage falls below the specified tolerance. See Performance/Functional Specifications. If the load current being drawn from the converter is significant enough, the unit will go into a short circuit condition. See "Short Circuit Condition."

Short Circuit Condition

When a converter is in current limit mode the output voltages will drop as the output current demand increases. If the output voltage drops too low, the magnetically coupled voltage used to develop primary side voltages will also drop, thereby shutting down the PWM controller.

Following a time-out period the PWM will restart causing the output voltages to begin ramping to their appropriate values. If the short-circuit condition persists, another shutdown cycle will be initiated. This on/off cycling is referred to as "hiccup" mode. The hiccup cycling reduces the average output current, thereby preventing internal temperatures from rising to excessive levels. The UWR 26-40 Watt A-Series is capable of enduring an indefinite short circuit output condition.

Thermal Shutdown

These A-Series converters are equipped with Thermal Shutdown Circuitry. If environmental conditions cause the internal temperature of the DC/DC converter to rise above the designed operating temperature, a precision temperature sensor will power down the unit. When the internal temperature decreases below the threshold of the temperature sensor the unit will self start. See Performance/Functional Specifications.

Output Overvoltage Protection

The output voltage is monitored for an overvoltage condition via magnetic coupling to the primary side. If the output voltage rises to a fault condition, which could be damaging to the load circuitry (see Performance Specifications), the sensing circuitry will power down the PWM controller causing the output voltage to decrease. Following a time-out period the PWM will restart, causing the output voltage to ramp to its appropriate value. If the fault condition persists, and the output voltages again climb to excessive levels, the overvoltage circuitry will initiate another shutdown cycle. This on/off cycling is referred to as "hiccup" mode.

Trimming Output Voltage

UWR 26-40W converters have a trim capability (pin 8) that allows users to adjust the output voltages ±5%. Adjustments to the output voltages can be accomplished via a trim pot (Figure 5) or a single fixed resistor as shown in Figures 6 and 7. A single fixed resistor can increase or decrease the output voltage depending on its connection. Resistors should be located close to the converter and have TCR's less than 100ppm/°C to minimize sensitivity to changes in temperature. If the trim function is not used, leave the trim pin floating.

A single resistor connected from the Trim (pin 8) to the +Output (pin 6), will decrease the output voltage. A resistor connected from the Trim (pin 8) to the -Output (pin 7), -Sense where applicable, will increase the output voltage.

Trim adjustments greater than the specified ±5% can have an adverse affect on the converter's performance and are not recommended. Excessive trim adjustment of the output voltage can cause the overvoltage protection circuitry to activate (see Performance Specifications for overvoltage limits). Power derating is based on maximum output current and voltage at the converter's output pins. Use of trim can cause output voltages to increase thereby increasing output power beyond the UWR's specified rating or cause output voltages to climb into the output overvoltage region. Therefore:

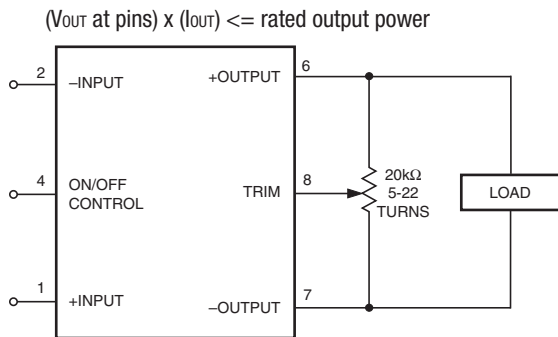

Figure 5. Trim Connections Using A Trimpot

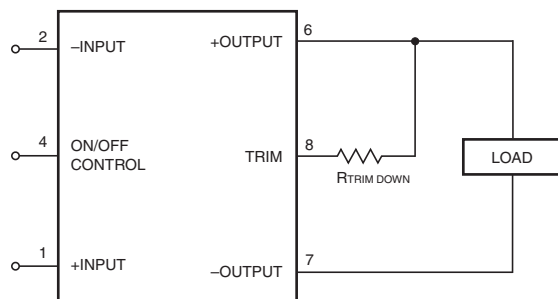

Figure 6. Trim Connections To Decrease Output Voltages Using Fixed Resistors

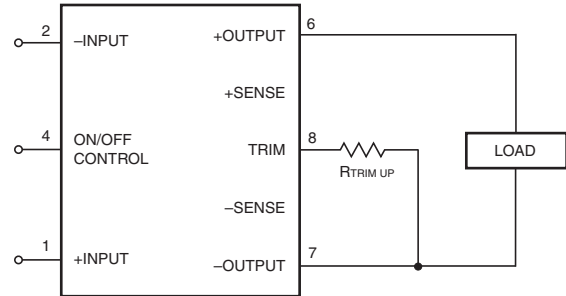

Figure 7. Trim Connections To Increase Output Voltages Using Fixed Resistors

Trim Equations For 3.3 Volt Models

$$R_{T_DOWN} (k\Omega) = \frac{2.49(V_O - 1.23)}{3.3 - V_O} - 13$$

$$R_{T_UP} (k\Omega) = \frac{3.06}{V_O - 3.3} - 13$$

Trim Equations For 5 Volt Models

$$R_{T_DOWN} (k\Omega) = \frac{2.49(V_O - 2.51)}{5 - V_O} - 16.9$$

$$R_{T_UP} (k\Omega) = \frac{6.25}{V_O - 5} - 16.9$$

Note: Resistor values are in kΩ. Accuracy of adjustment is subject to the tolerances of resistors and factory-adjusted output accuracy.

V_O = desired output voltage.

Soldering Guidelines

Murata Power Solutions recommends the specifications below when installing these converters. These specifications vary depending on the solder type. Exceeding these specifications may cause damage to the product. Be cautious when there is high atmospheric humidity. We strongly recommend a mild pre-bake (100° C. for 30 minutes). Your production environment may differ; therefore please thoroughly review these guidelines with your process engineers.

Wave Solder Operations for through-hole mounted products (THMT)

For Sn/Ag/Cu based solders:

Maximum Preheat Temperature	115° C.
Maximum Pot Temperature	270° C.
Maximum Solder Dwell Time	7 seconds

For Sn/Pb based solders:

Maximum Preheat Temperature	105° C.
Maximum Pot Temperature	250° C.
Maximum Solder Dwell Time	6 seconds

TYPICAL PERFORMANCE CURVES

UWR-3.3/8-D12 Efficiency vs. Load @ 25°C Ambient

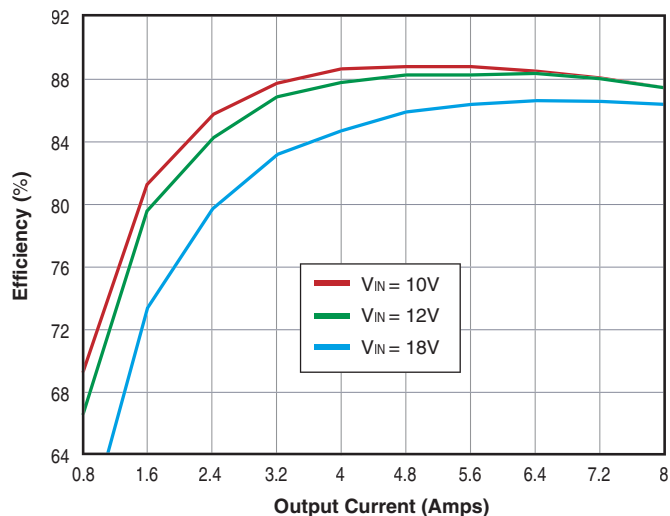

UWR-5/7-D12 Efficiency vs. Load @ 25°C Ambient

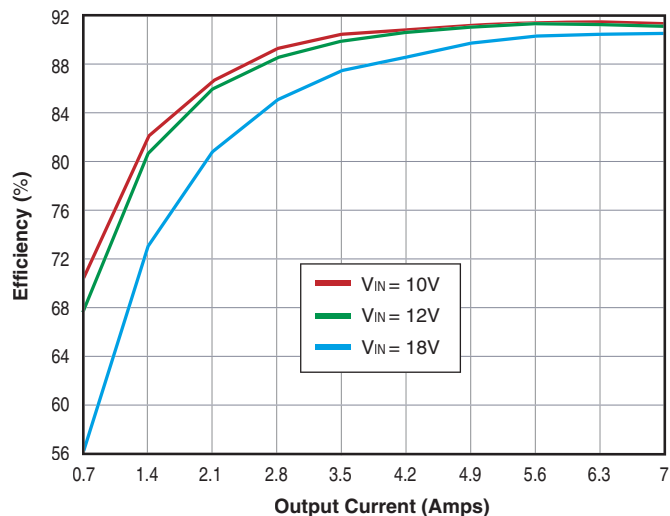

UWR-3.3/9-D24 Efficiency vs. Load @ 25°C Ambient

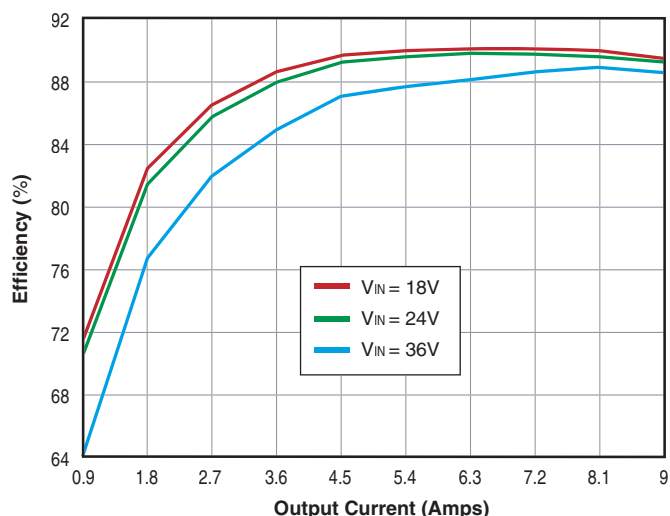

UWR-5/8-D24 Efficiency vs. Load @ 25°C Ambient

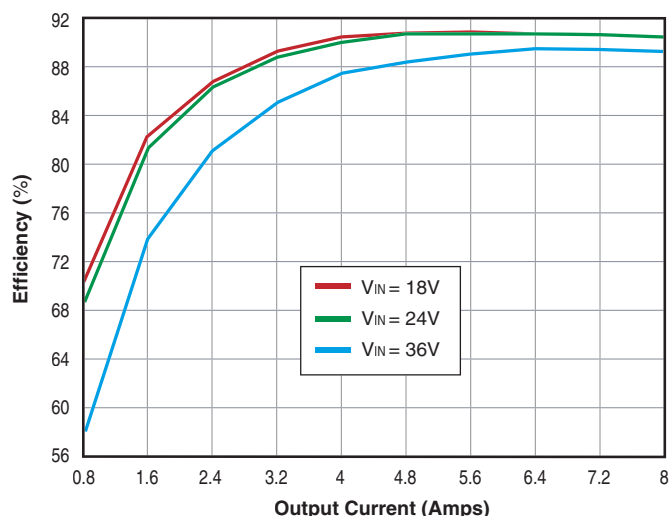

UWR-3.3/9-D48 Efficiency vs. Load @ 25°C Ambient

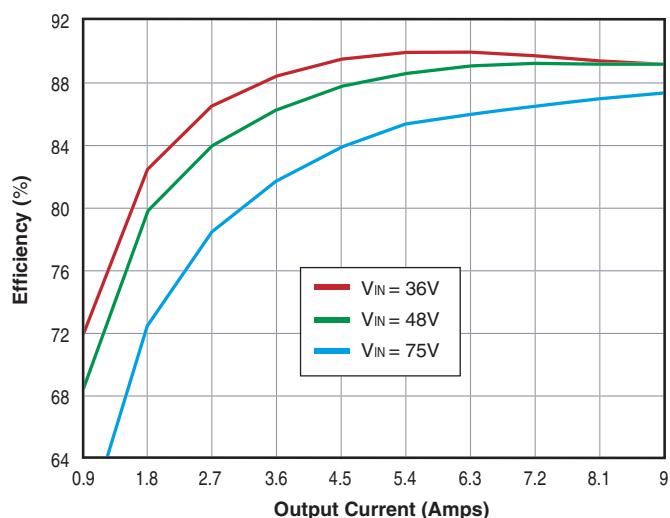

UWR-5/8-D48 Efficiency vs. Load @ 25°C Ambient

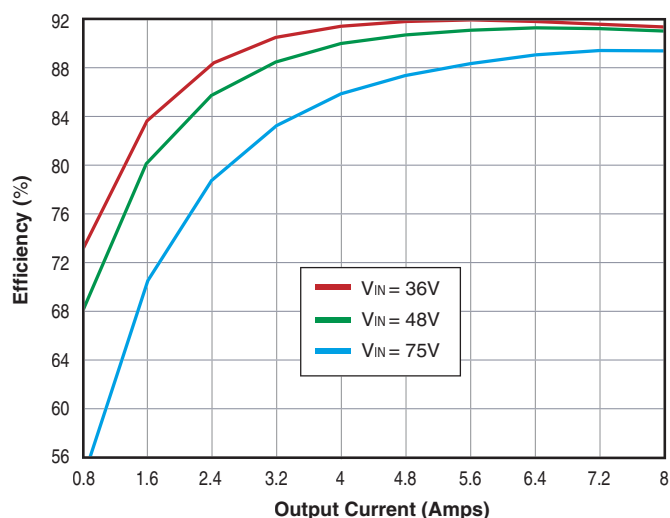

TYPICAL PERFORMANCE CURVES

UWR-3.3/8-D12A Start-Up from V_{IN}

(V_{IN} = 12V, full load, external 0.47μF output capacitor.)

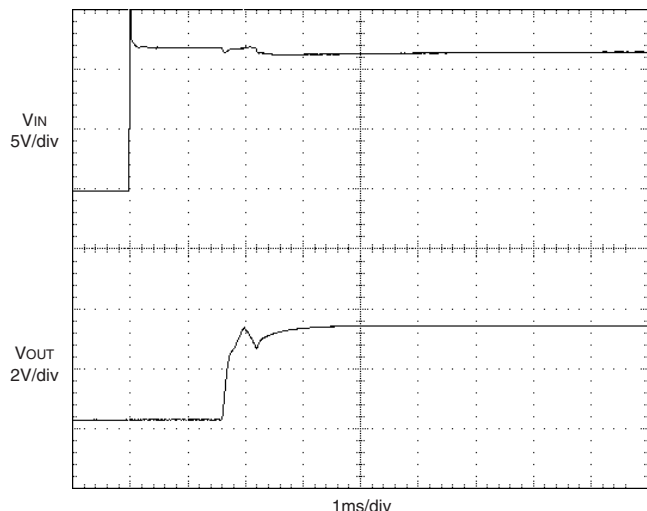

UWR-3.3/8-D12A Output Ripple and Noise (PARD)

(V_{IN} = 12V, full load, external 0.47μF output capacitor.)

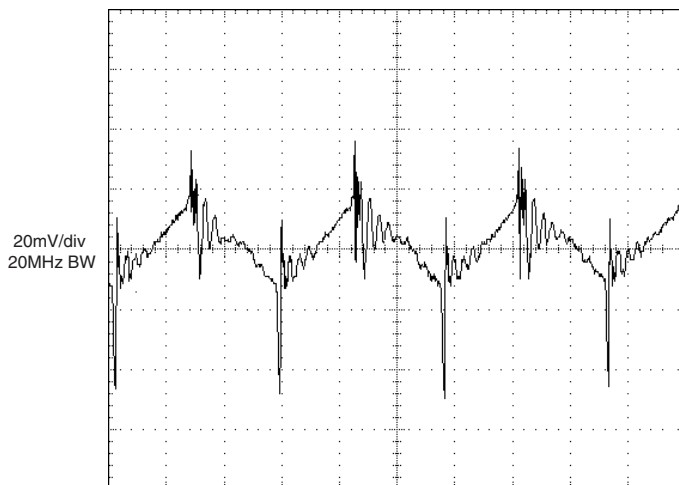

UWR-3.3/9-D24A Start-Up from V_{IN}

(V_{IN} = 24V, full load, external 0.47μF output capacitor.)

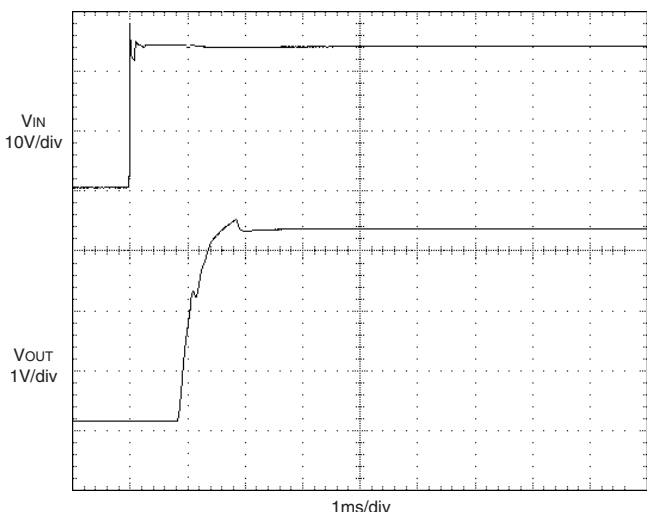

UWR-3.3/9-D24A Output Ripple and Noise (PARD)

(V_{IN} = 24V, full load, external 0.47μF output capacitor.)

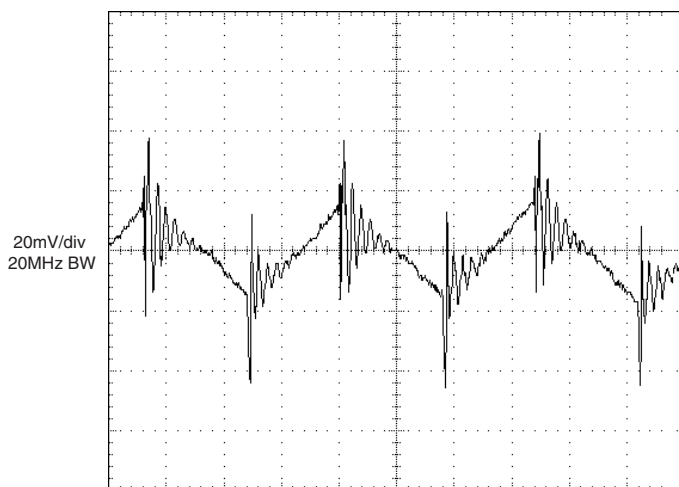

UWR-3.3/9-D48A Start-Up from V_{IN}

(V_{IN} = 48V, full load, external 0.47μF output capacitor.)

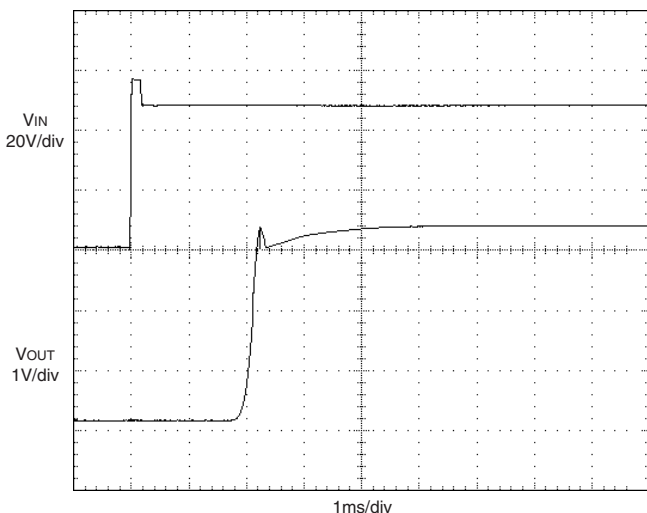

UWR-3.3/9-D48A Output Ripple and Noise (PARD)

(V_{IN} = 48V, full load, external 0.47μF output capacitor.)

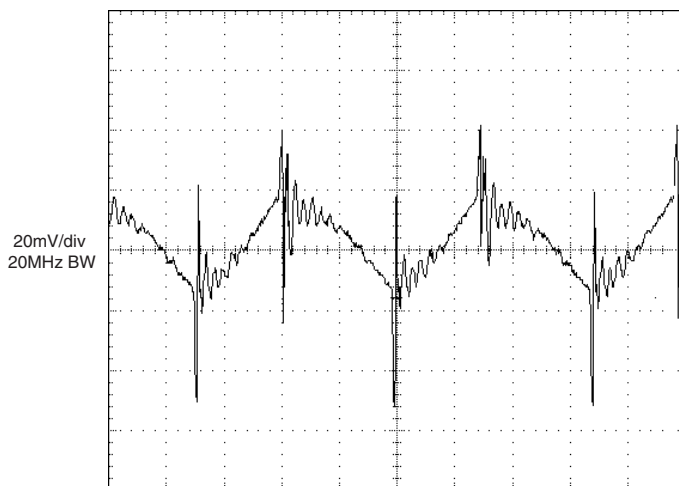

TYPICAL PERFORMANCE CURVES

UWR-5/7-D12A Start-Up from V_{IN}
(V_{IN} = 12V, full load, external 0.47μF output capacitor.)

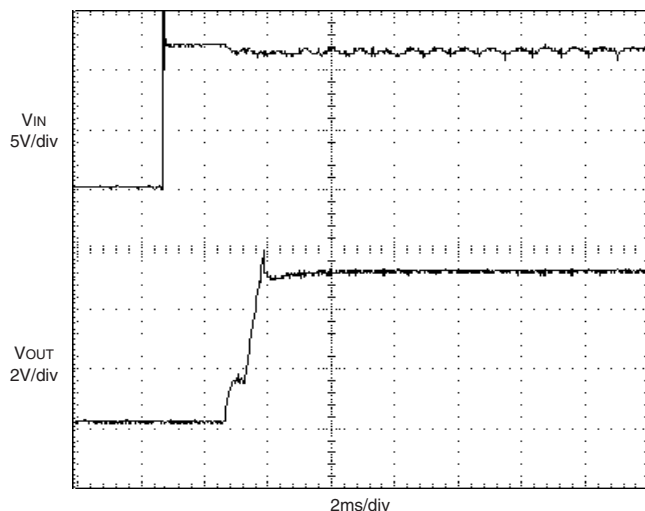

UWR-5/8-D12A Output Ripple and Noise (PARD)
(V_{IN} = 12V, full load, external 0.47μF output capacitor.)

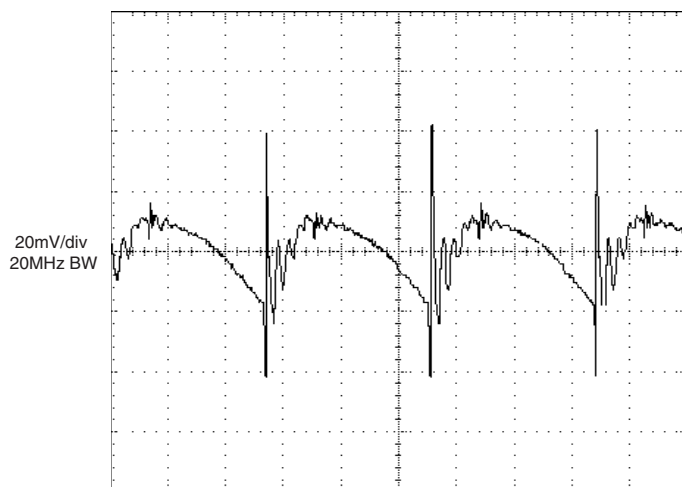

UWR-5/8-D24A Start-Up from V_{IN}
(V_{IN} = 24V, full load, external 0.47μF output capacitor.)

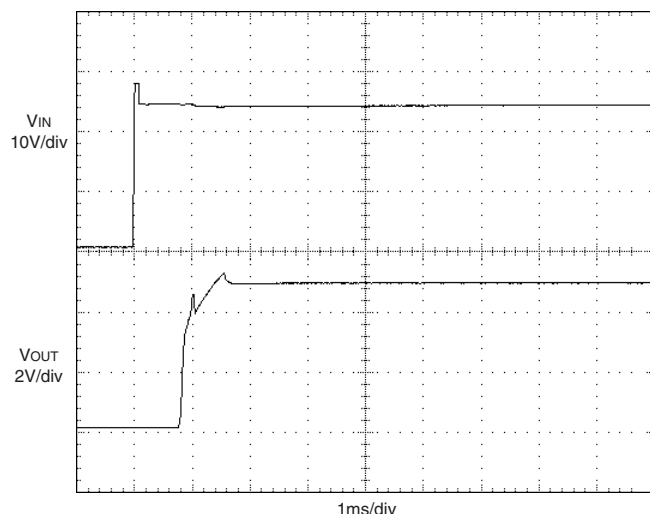

UWR-5/8-D24A Output Ripple and Noise (PARD)
(V_{IN} = 24V, full load, external 0.47μF output capacitor.)

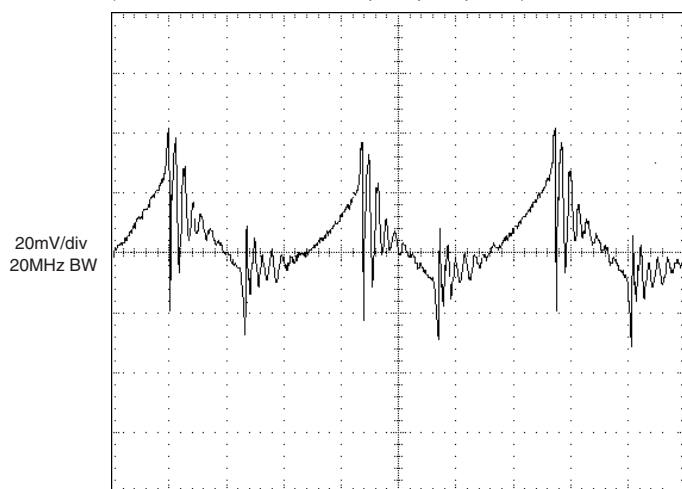

UWR-5/8-D48A Start-Up from V_{IN}
(V_{IN} = 48V, full load, external 0.47μF output capacitor.)

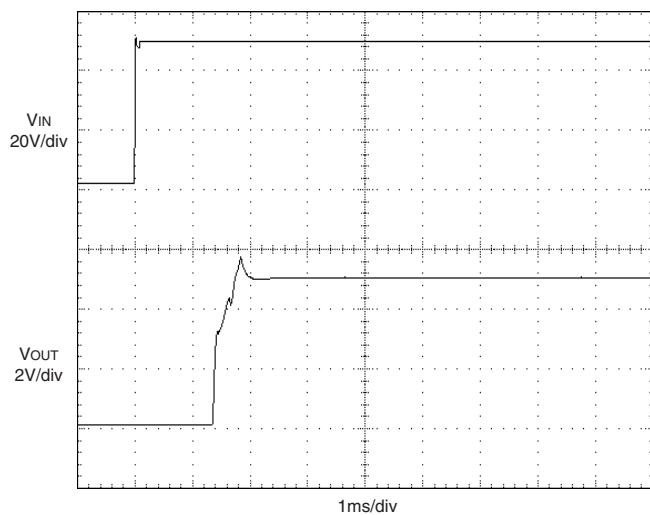

UWR-5/8-D48A Output Ripple and Noise (PARD)
(V_{IN} = 48V, full load, external 0.47μF output capacitor.)

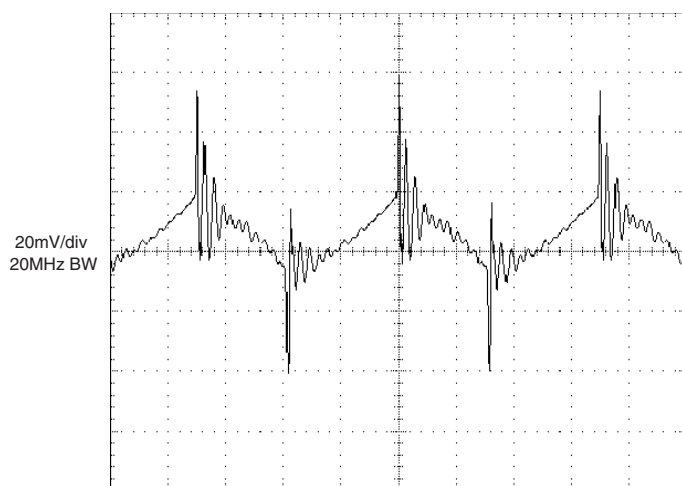

TYPICAL PERFORMANCE CURVES

