

**VM-700 Type
Incandescent Vaportight
Size T-3 1/4**



Cap
Transparent plastic with O-ring. If translucent cap is desired, add "TL" to final dash number

Base Assembly
Aluminum - standard finish is bright anodize

Light Assembly
Completely sealed and will withstand immersion in liquid

Weight
Approx. 1 oz., less lamp

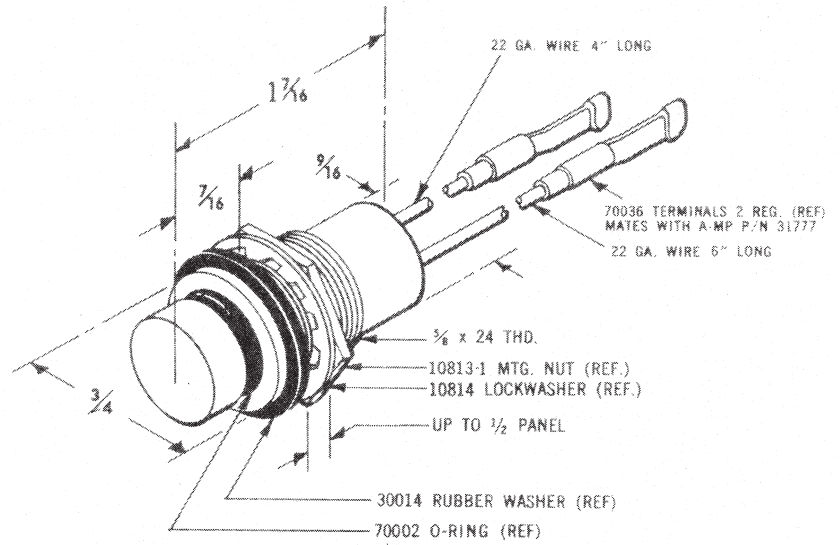

**99-36980 Type
99-36982 Type
Incandescent Subminiature
Size T-1**



Material and Finishes
Mounting tube and nut, stainless steel, passivated per MIL-S-5002. Wire leads #26 GA silver coated, stranded copper with TFE-fluorocarbon insulation.

Lens Assembly
Lens, high impact-resistant plastic per L-P-393 (polycarbonate).

Lamp
MS24367-683 subminiature T-1 with 5.0V at .060 amp rating (non-replaceable).

Mounting
Assembly mounts from front of panel. All mounting hardware supplied. E.M.I. suppressed assemblies require paint free area on back side of mounting for E.M.I. conductivity.

Weight
Approx. .005 lbs. max.

EMI Suppressed

98-36980
99-36980
LHC82 §

98-36982
99-36982
LHC84 §

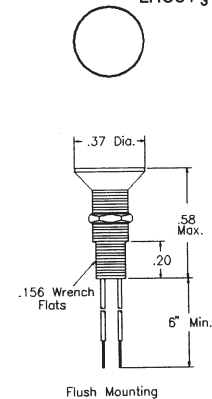
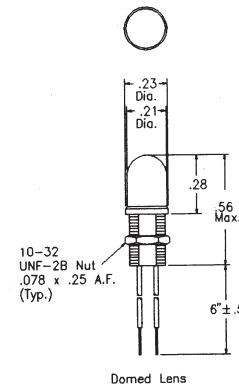

Panel Cutouts

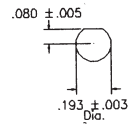

Domed Lens Flat Lens

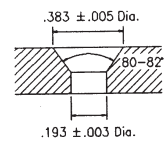

Flush Mounting

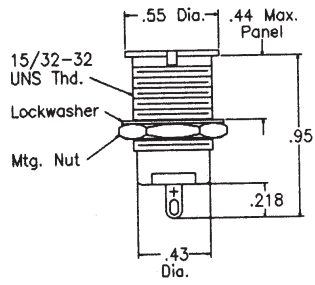

()P41
LC28

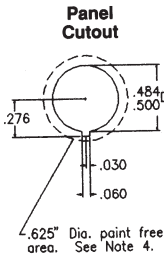
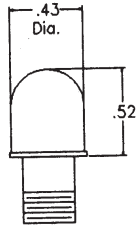

Schematic

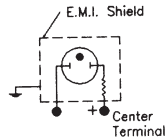

Material and Finishes

Mounting tube and nuts, brass plated, nickel plated per QQ-N-290. Lockwasher, stainless steel or steel, nickel plate. Brass terminals, tin plated per MIL-T-10727A.

Cap Assembly

Lens, high impact-resistant plastic per L-P-349. Standard colors are transparent.

Lamp

C7A (std.) or C9A (high brightness) T2 neon lamp is furnished with each assembly.

Mounting

Assembly mounts from front of panel. All mounting hardware supplied. Recommended mounting hole .500 in. +/- .015 in. dia. Paint free area around backside hole required for E.M.I. conductivity.

Weight

Approx. .3 oz. less lamp.

**38-36180 Type
Neon Miniature
Size T-2**

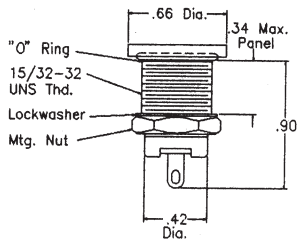

()P45

()P50

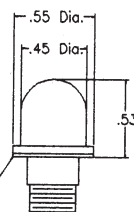
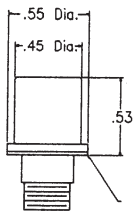

Schematic

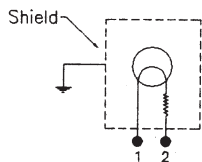

Material and Finishes

Mounting tube and nut, brass, bright nickel finish. Lockwasher stainless steel or steel nickel plate. Brass terminals, tin plated per MIL-T-10727A. "O" ring, silicone rubber.

Cap Assembly

Lens, high impact-resistant plastic per L-P-349 Lens holders, brass, bright nickel plated.

Lamp

T-1 3/4 midget flange base.

Mounting

Assembly mounts from front of panel. All mounting hardware supplied. Recommended mounting hole .500 in. +/- .015 in. dia. Paint free area around back side of hole required for E.M.I. conductivity.

Weight

Approximately .35 oz. less lamp.

**38-36680 Type
w/68K Internal Resistor
38-36681 Type
w/27K Internal Resistor
Neon Miniature Watertight
Size T-1 3/4**



18-36880 Type Base was designed to LH 73/2 Neon Miniature Size T-1 3/4



Material and Finishes
Mounting tube and nut, brass, bright nickel finish. Lockwasher, stainless steel or steel nickel plate. Brass terminals, tin plated per MIL-T-10727A. "O" ring, silicone rubber.

Cap Assembly
Lens, high impact-resistant plastic per L-P-349 Lens holders, brass, bright nickel plated.

Lamp
T-1 3/4 midget flange base.

Mounting
Assembly mounts from front of panel. All mounting hardware supplied. Recommended mounting hole .500 in. ± 0.15 in. dia. Paint free area around back side of hole required for E.M.I. conductivity.

Weight
Approximately .35 oz. less lamp.

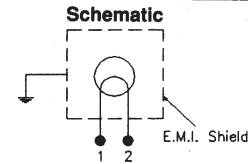
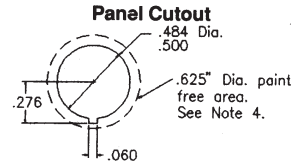
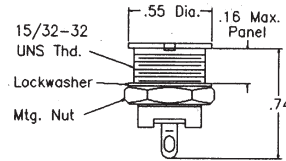

()P38
LC25

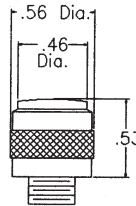

()P40
LC27

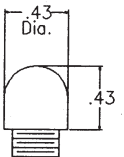

18-36680 Type Incandescent Miniature Watertight - Size T-1 3/4



Material and Finishes
Mounting tube and exposed hardware, brass, bright nickel plate per QQ-N-290. Lockwasher, stainless steel or steel, nickel plate. Terminals, brass, tin plated per MIL-T-10727A.

Cap Assembly
Lens is high impact-resistant plastic per L-P-349.

Lamp
T-1 3/4 midget flange base.

Mounting
Assembly mounts from front of panel. All mounting hardware supplied. E.M.I. suppressed assemblies require paint free area on back side of mounting hole for E.M.I. conductivity.

Weight
Approx. .35 oz less lamp.

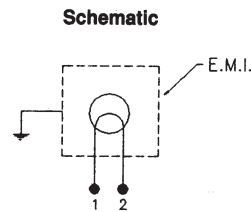
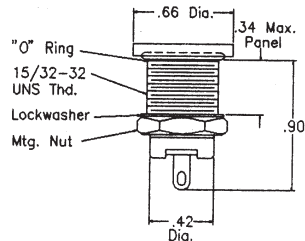

()P45

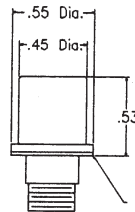

()P50

