

FODB100, FODB101, FODB102 Single Channel Microcoupler™

Features

- Low profile package (1.20mm maximum mounted height)
- Land pattern allows for optimum board space savings
- High Current Transfer Ratio (CTR) at low IF
- Minimum isolation distance of 0.45mm
- High steady state isolation voltage of 2500V_{rms}
- Data rates up to 120Kbit/s (NRZ)
- Minimum creepage distance of 2mm
- Wide operating temperature range of -40°C to +125°C
- Available in tape and reel quantities of 3000 units
- Applicable to Pb-free Infrared Ray reflow (260°C max)
- UL and VDE approved

Applications

- Primarily suited for DC-DC converters
- For ground loop isolation, signal to noise isolation
 - Communications – chargers, adapters
 - Consumer – appliances, set top boxes
 - Industrial – power supplies, motor control

Description

The FODB100, FODB101 and FODB102 single channel MICROCOUPLERS™ are all Pb-free, low profile miniature surface mount optocouplers in a Ball Grid Array (BGA) package. Each consists of an aluminum gallium arsenide (AlGaAs) infrared emitting diode driving a silicon phototransistor.

Schematic

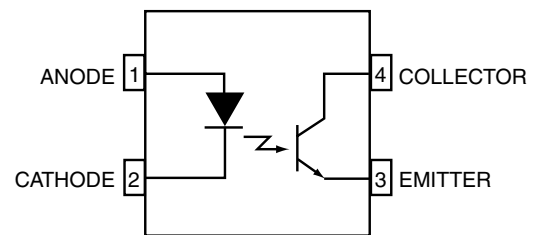

Package Dimensions

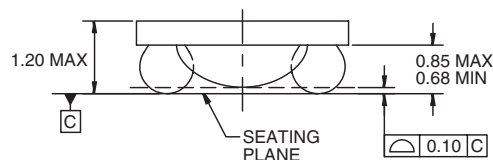
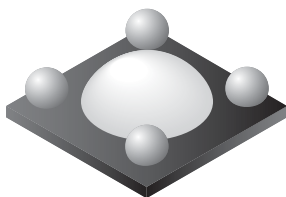
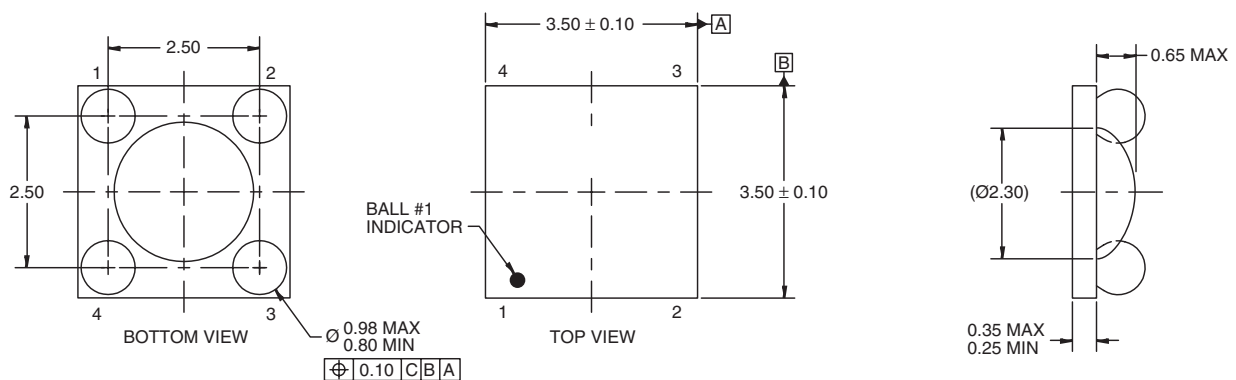

NOTES: UNLESS OTHERWISE SPECIFIED
A) ALL DIMENSIONS ARE IN MILLIMETERS.
B) NO JEDEC REGISTRATION REFERENCE AS OF NOVEMBER 2002.

Absolute Maximum Ratings ($T_A = 25^\circ\text{C}$ Unless otherwise specified)

Symbol	Parameter	Value	Units
TOTAL PACKAGE			
T_{STG}	Storage Temperature	-55 to +150	$^\circ\text{C}$
T_{OPR}	Operating Temperature	-40 to +125	$^\circ\text{C}$
T_j	Junction Temperature	130	$^\circ\text{C}$
EMITTER			
I_F (avg)	Continuous Forward Current	30	mA
V_R	Reverse Input Voltage	6	V
P_D	Power Dissipation	40	mW
	Derate linearly (above 25°C)	0.39	mW/ $^\circ\text{C}$
DETECTOR			
	Continuous Collector Current	50	mA
P_D	Power Dissipation	150	mW
	Derate linearly (above 25°C)	1.42	mW/ $^\circ\text{C}$
V_{CEO}	Collector-Emitter Voltage	75	V
V_{ECO}	Emitter-Collector Voltage	7	V

Electrical Characteristics ($T_A = 25^\circ\text{C}$ Unless otherwise specified)**Individual Component Characteristics**

Symbol	Parameter	Test Conditions	Min.	Typ.	Max.	Unit
EMITTER						
V_F	Forward Voltage	$I_F = 2\text{mA}$	1.0		1.5	V
I_R	Reverse Current	$V_R = 6\text{V}$			10	μA
DETECTOR						
BV_{CEO}	Breakdown Voltage Collector to Emitter	$I_C = 100\mu\text{A}, I_F = 0$	75			V
BV_{ECO}	Emitter to Collector	$I_E = 100\mu\text{A}, I_F = 0$	7			V
I_{CEO}	Collector Dark Current ⁽¹⁾	$V_{CE} = 75\text{V}, I_F = 0$			100	nA
C_{CE}	Capacitance	$V_{CE} = 0\text{V}, f = 1\text{MHz}$		8		pF

Transfer Characteristics

Symbol	Characteristic	Test Conditions	Min.	Typ.	Max.	Unit
CTR	Current Transfer Ratio ⁽²⁾	$I_F = 1\text{mA}, V_{CE} = 5\text{V}$	100			%
$CTR_{CE(SAT)}$	Saturated Current Transfer Ratio (Collector to Emitter)	$I_F = 1.6\text{mA}, V_{CE} = 0.4\text{V}$	100			%
		$I_F = 1.0\text{mA}, V_{CE} = 0.4\text{V}$	75			
$V_{CE(SAT)}$	Saturation Voltage	$I_F = 3.0\text{mA}, I_C = 1.8\text{mA}$			0.4	V
		$I_F = 1.6\text{mA}, I_C = 1.6\text{mA}$				
t_r	Rise Time (Non-Saturated)	$I_C = 2\text{mA}, V_{CE} = 5\text{V}, R_L = 1\text{k}\Omega$		1		μs
t_f	Fall Time (Non-Saturated)	$I_C = 2\text{mA}, V_{CE} = 5\text{V}, R_L = 1\text{k}\Omega$		5		
T_{PHL}	Propagation Delay High to Low	$I_F = 1.6\text{mA}, V_{CC} = 5.0\text{V}, R_L = 750\Omega$		3		μs
		$I_F = 1.6\text{mA}, V_{CC} = 5.0\text{V}, R_L = 4.7\text{k}\Omega$		12		
T_{PLH}	Propagation Delay Low to High	$I_F = 1.6\text{mA}, V_{CC} = 5.0\text{V}, R_L = 750\Omega$		5		μs
		$I_F = 1.6\text{mA}, V_{CC} = 5.0\text{V}, R_L = 4.7\text{k}\Omega$		19		

Isolation Characteristics

Symbol	Characteristic	Test Conditions	Min.	Typ.	Max.	Unit
V_{ISO}	Steady State Isolation Voltage ⁽³⁾	$RH \leq 50\%, T_A = 25^\circ\text{C}, t = 1\text{ sec}$	2500			V(rms)
R_{ISO}	Resistance (input to output) ⁽³⁾	$V_{I-O} = 500\text{VDC}$	10^{12}			Ω
C_{ISO}	Capacitance (input to output) ⁽³⁾	$f = 1\text{MHz}$		0.3	0.5	pF

Notes:

- The white dome area is sensitive to high intensity ambient light or any light source in the 500nm to 1200nm wavelength range. If such a light source is present, the part should be covered or protected. If the white dome is exposed to such a light source, the output leakage parameter of the phototransistor will increase.
- CTR bin (FODB100 only)
FODB101: 100% – 200%
FODB102: 150% – 300%
- Pin 1 and Pin 2 are shorted as input and Pin 3 and Pin 4 are shorted as output.

Typical Performance Characteristics

Fig. 1 Normalized CTR vs. Temperature (VCE = 2V)

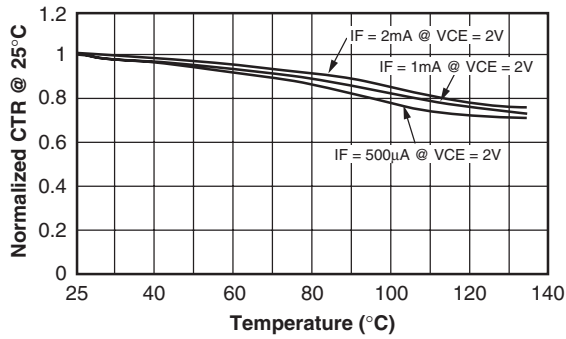

Fig. 2 Normalized CTR vs. Temperature (VCE = 5V)

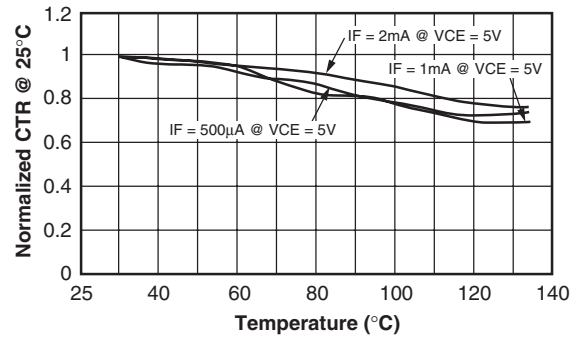

Fig. 3 Current Transfer Ratio vs. Collector to Emitter Voltage

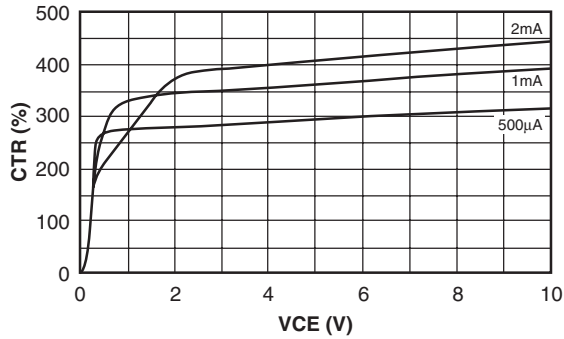

Fig. 4 Current Transfer Ratio vs. Collector Saturation Voltage

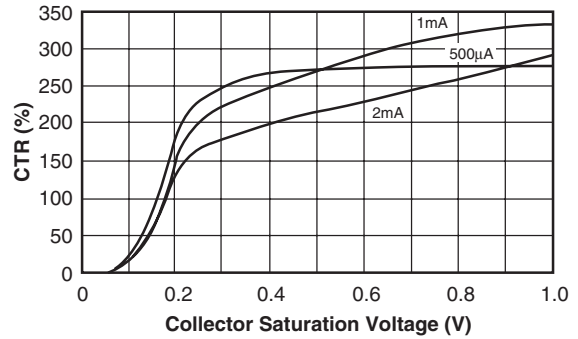
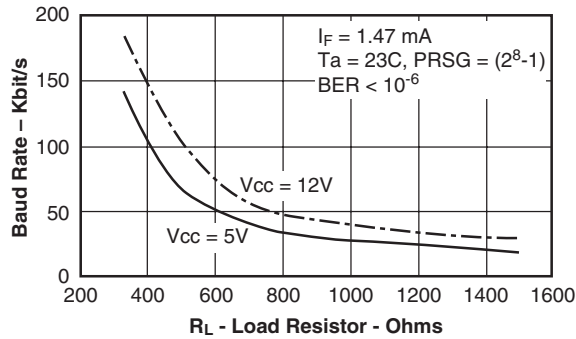
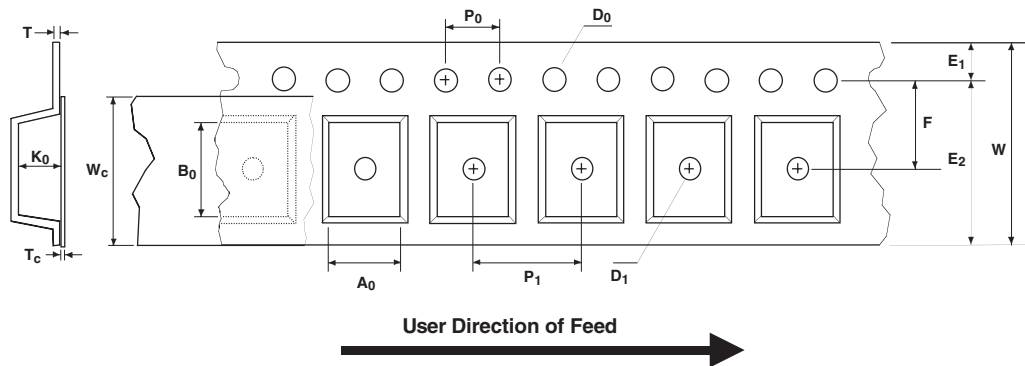

Fig. 5 Baud Rate vs. Load Resistor



Tape and Reel Specifications

Embossed Carrier Tape Configuration



Dimensions are in millimeter														
Pkg type	A_0	B_0	W	D_0	D_1	E_1	E_2	F	P_1	P_0	K_0	T	W_c	T_c
Optocoupler (12mm)	3.80 ±0.10	3.80 ±0.10	12.0 +0.3/-0.1	1.50 +0.25/-0.00	1.50 +0.25/-0.00	1.75 ±0.10	10.25 min	5.50 ±0.05	8.0 ±0.1	4.0 ±0.1	1.40 ±0.10	0.279 ±0.02	9.2 ±0.3	0.06 ±0.02

Notes: A_0 , B_0 , and K_0 dimensions are determined with respect to the EIA/Jedec RS-481 rotational and lateral movement requirements (see sketches A, B, and C).

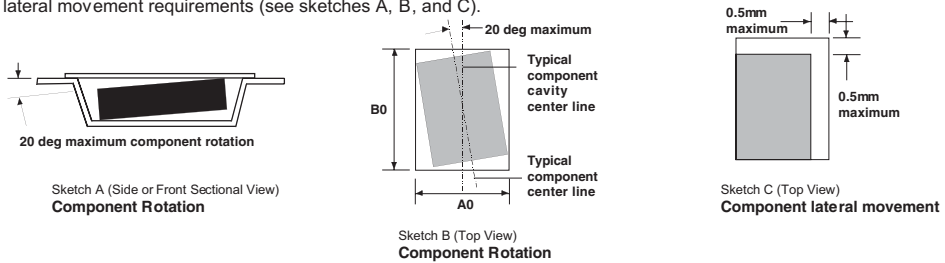

Optocoupler Reel Configuration

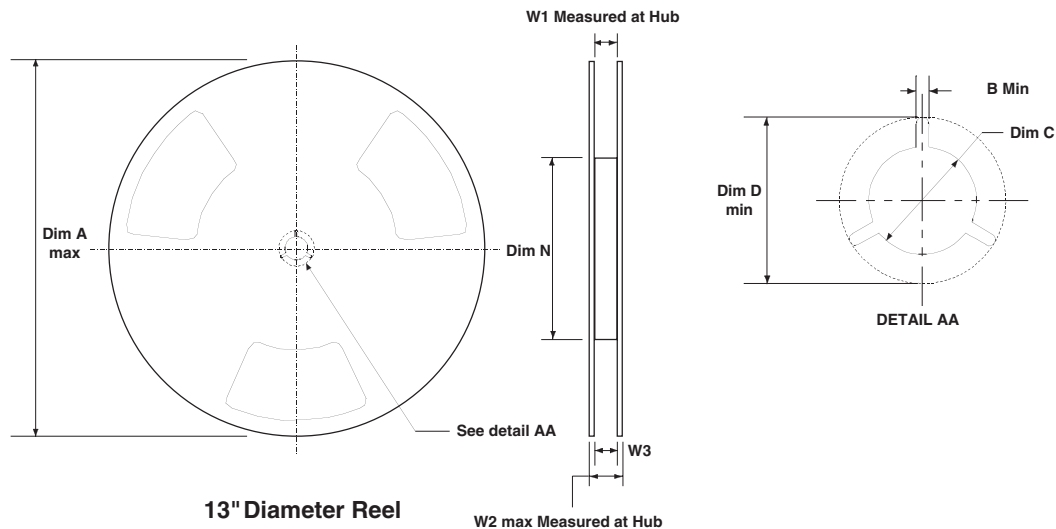

Dimension are in inches and millimeters									
Tape Size	Reel Option	Dim A	Dim B	Dim C	Dim D	Dim N	Dim W1	Dim W2	Dim W3 (LSL-USL)
12mm	13" Dia	13.00 330	0.059 1.5	512 +0.020/-0.008 13 +0.5/-0.2	0.795 20.2	7.00 178	0.488 +0.078/-0.000 12.4 +2/-0	0.724 18.4	0.469 - 0.606 11.9 - 15.4

Marking Information

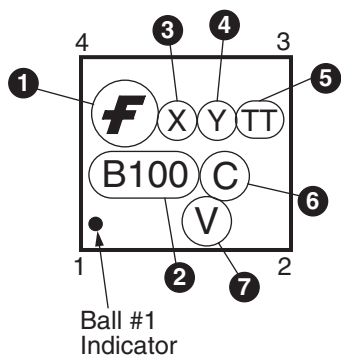

Definitions	
1	Fairchild logo
2	Device number (FODB100)
3	One digit year code e.g. "E" for 2004
4	6-week date code character
5	Die Run Code
6	Assembly package code
7	VDE 0884 approved (Optional)

Note: The device number prefix of "FOD" will be omitted in the part number

Recommended Footprint Drawing for PCB Layout

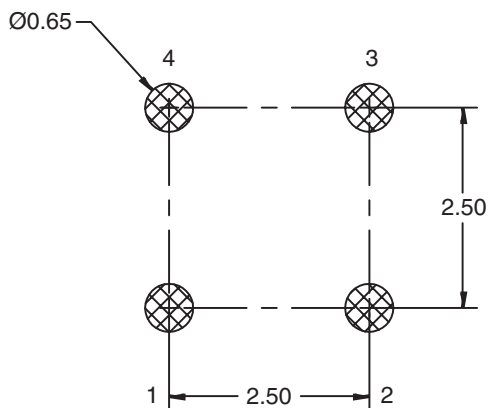

- Note:**
1. All dimensions in millimeters (mm)
 2. It is recommended to use 6 mils of stencil thickness on PCB

Recommended Infrared Reflow Soldering Profile

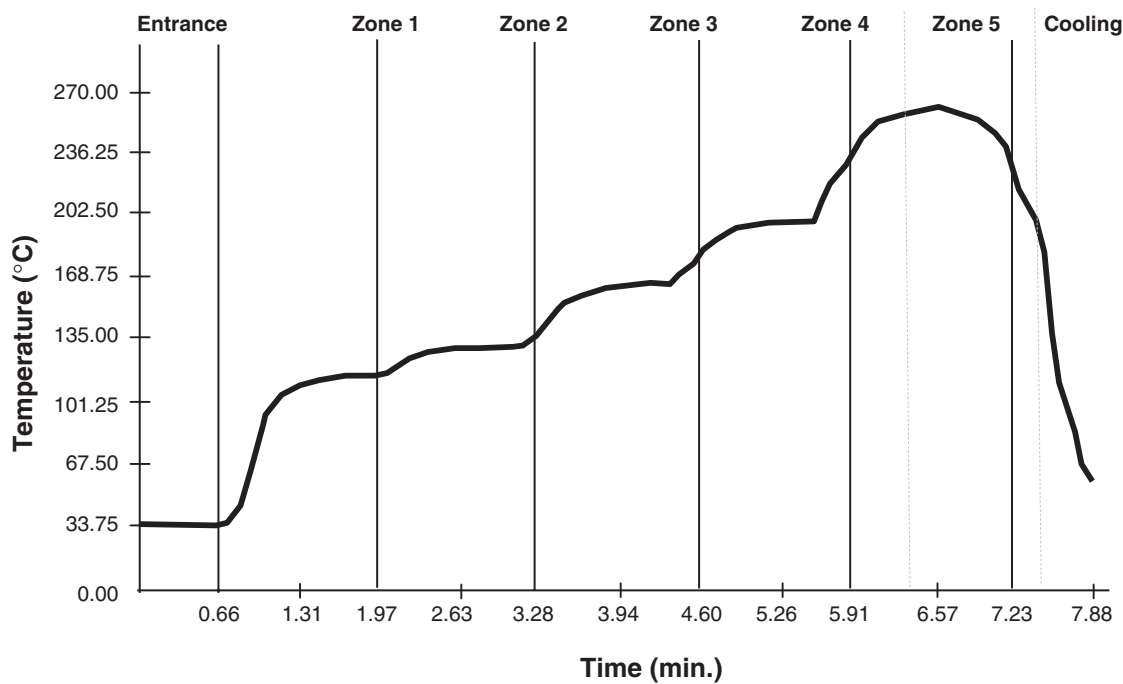

Reflow Profile for Pb Free

	Convection Reflow
Average ramp-up rate (183°C to peak)	3°C/sec max
Preheat Temperature 125(±25)°C to 200°C	60-180°C
Temperature maintained above 220°C	60-150 sec
Time within 5°C of actual peak temperature	20-40 sec
Peak temperature range	260 ±5°C
Ramp down rate	6°C/sec max
Time 25°C to peak temperature	8min max

Note: Surface Mount Adhesives (SMA) isn't recommended to be used on the dome area (white dome).

TRADEMARKS

The following are registered and unregistered trademarks Fairchild Semiconductor owns or is authorized to use and is not intended to be an exhaustive list of all such trademarks.

ACE [™]	FACT Quiet Series [™]	OCX [™]	SILENT SWITCHER [®]	UniFET [™]
ActiveArray [™]	GlobalOptoisolator [™]	OCXPro [™]	SMART START [™]	UltraFET [®]
Bottomless [™]	GTO [™]	OPTOLOGIC [®]	SPM [™]	VCX [™]
Build it Now [™]	HiSeC [™]	OPTOPLANAR [™]	Stealth [™]	Wire [™]
CoolFET [™]	I ² C [™]	PACMAN [™]	SuperFET [™]	
CROSSVOLT [™]	i-Lo [™]	POP [™]	SuperSOT [™] -3	
DOME [™]	ImpliedDisconnect [™]	Power247 [™]	SuperSOT [™] -6	
EcoSPARK [™]	IntelliMAX [™]	PowerEdge [™]	SuperSOT [™] -8	
E ² CMOS [™]	ISOPLANAR [™]	PowerSaver [™]	SyncFET [™]	
EnSigna [™]	LittleFET [™]	PowerTrench [®]	TCM [™]	
FACT [™]	MICROCOUPLER [™]	QFET [®]	TinyBoost [™]	
FAST [®]	MicroFET [™]	QS [™]	TinyBuck [™]	
FASTr [™]	MicroPak [™]	QT Optoelectronics [™]	TinyPWM [™]	
FPS [™]	MICROWIRE [™]	Quiet Series [™]	TinyPower [™]	
FRFET [™]	MSX [™]	RapidConfigure [™]	TinyLogic [®]	
	MSXPro [™]	RapidConnect [™]	TINYOPTO [™]	
Across the board. Around the world. [™]		μSerDes [™]	TruTranslation [™]	
The Power Franchise [®]		ScalarPump [™]	UHC [™]	
Programmable Active Droop [™]				

DISCLAIMER

FAIRCHILD SEMICONDUCTOR RESERVES THE RIGHT TO MAKE CHANGES WITHOUT FURTHER NOTICE TO ANY PRODUCTS HEREIN TO IMPROVE RELIABILITY, FUNCTION, OR DESIGN. FAIRCHILD DOES NOT ASSUME ANY LIABILITY ARISING OUT OF THE APPLICATION OR USE OF ANY PRODUCT OR CIRCUIT DESCRIBED HEREIN; NEITHER DOES IT CONVEY ANY LICENSE UNDER ITS PATENT RIGHTS, NOR THE RIGHTS OF OTHERS. THESE SPECIFICATIONS DO NOT EXPAND THE TERMS OF FAIRCHILD'S WORLDWIDE TERMS AND CONDITIONS, SPECIFICALLY THE WARRANTY THEREIN, WHICH COVERS THESE PRODUCTS.

LIFE SUPPORT POLICY

FAIRCHILD'S PRODUCTS ARE NOT AUTHORIZED FOR USE AS CRITICAL COMPONENTS IN LIFE SUPPORT DEVICES OR SYSTEMS WITHOUT THE EXPRESS WRITTEN APPROVAL OF FAIRCHILD SEMICONDUCTOR CORPORATION.

As used herein:

1. Life support devices or systems are devices or systems which, (a) are intended for surgical implant into the body, or (b) support or sustain life, or (c) whose failure to perform when properly used in accordance with instructions for use provided in the labeling, can be reasonably expected to result in significant injury to the user.
2. A critical component is any component of a life support device or system whose failure to perform can be reasonably expected to cause the failure of the life support device or system, or to affect its safety or effectiveness.

PRODUCT STATUS DEFINITIONS

Definition of Terms

Datasheet Identification	Product Status	Definition
Advance Information	Formative or In Design	This datasheet contains the design specifications for product development. Specifications may change in any manner without notice.
Preliminary	First Production	This datasheet contains preliminary data, and supplementary data will be published at a later date. Fairchild Semiconductor reserves the right to make changes at any time without notice to improve design.
No Identification Needed	Full Production	This datasheet contains final specifications. Fairchild Semiconductor reserves the right to make changes at any time without notice to improve design.
Obsolete	Not In Production	This datasheet contains specifications on a product that has been discontinued by Fairchild semiconductor. The datasheet is printed for reference information only.

Rev. I20