

# 10-Watt Lednium SMD (120° Viewing Angle)

## OVTL09LGx Series

- Revolutionary 3-dimensional packaged LED source
- Robust energy-efficient design with long operating life
- Low thermal resistance
- Exceptional spatial uniformity
- Available in amber, blue, green, red, white and multi-colored

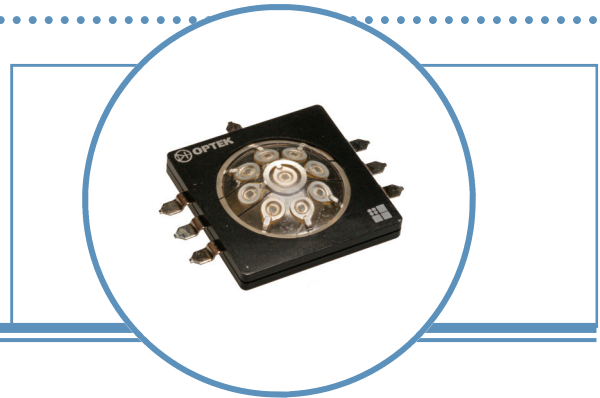

The **OVTL09LGx Series** surface mount provides a 10-Watt energy-efficient 3-dimensional packaged LED source that offers high luminance (up to 330 lumens), low thermal resistance and a long operating lifespan. Devices offer a 120° viewing angle and are available in amber, blue, green, red, white and multi-colored. Optional optics are offered to suit application. Please contact OPTEK for additional information.

## Applications

- Automotive exterior and interior lighting
- Architectural lighting
- Electronic signs and signals

## Flux Characteristics ( $I_F = 1.05 \text{ A}$ , $T_J = 25^\circ \text{ C}$ )

Part Number	Viewing Angle	Emitted Color	Typical Luminous Flux (lm)	Typical On-Axis Intensity (cd)	Lens Color
OVTL09LGAA	120°	Amber	330	67	Water Clear
OVTL09LGAB	120°	Blue	60	19	Water Clear
OVTL09LGAG	120°	Green	290	100	Water Clear
OVTL09LGAR	120°	Red	247	75	Water Clear
OVTL09LGAW	120°	White	250	70	Water Clear
OVTL09LGAM	120°	Red/Green/Blue	221	68	Water Clear

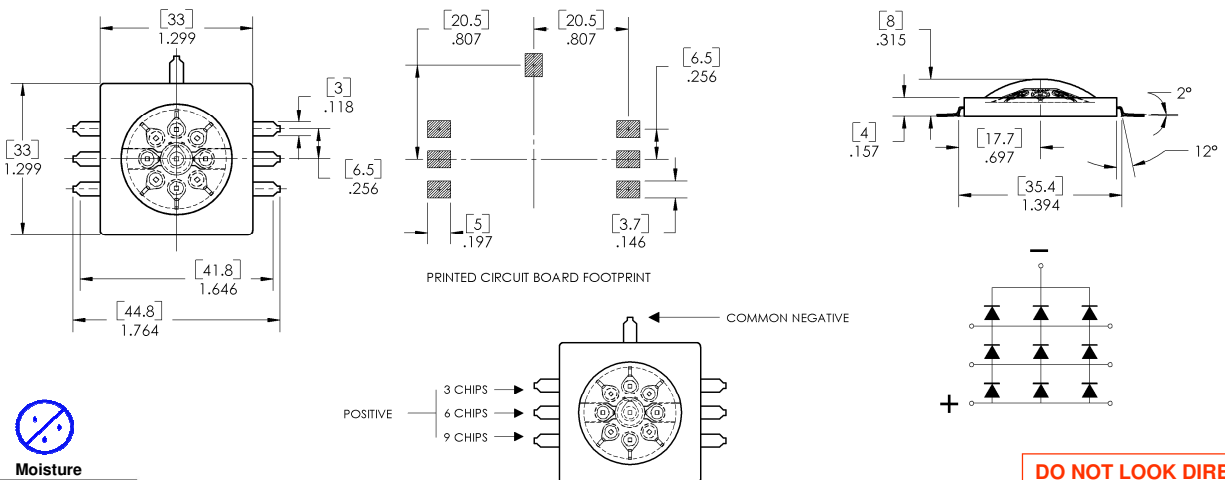

DIMENSIONS ARE IN: [MILLIMETERS]  
INCHES

**DO NOT LOOK DIRECTLY AT LED WITH UNSHIELDED EYES OR DAMAGE TO RETINA MAY OCCUR.**

OPTEK reserves the right to make changes at any time in order to improve design and to supply the best product possible.

## Absolute Maximum Ratings

DC Forward Current	1.05 A
Peak Pulsed Forward Current <sup>1</sup>	3 A
Reverse Voltage	15 V
Maximum Allowable Junction Temperature <sup>2</sup>	130 °C
Storage and Operating Temperature	-50 ° ~ +85 ° C

Notes:

1. Pulse width 1 ms maximum, duty cycle 1/16.
2. Thermal resistance junction to board ( $T_{JB}$ ) is 5 ° C/W.

## Electrical Characteristics ( $I_F = 1.05 \text{ A}$ , $T_J = 25^\circ \text{ C}$ )

SYMBOL	PARAMETER	MIN	TYP	MAX	UNITS
$V_F$	Forward Voltage ( <b>Amber</b> )	6.3	7.0	7.9	V
	Forward Voltage ( <b>Blue</b> )	9.5	10.2	11.2	V
	Forward Voltage ( <b>Green</b> )	10.3	11.0	11.9	V
	Forward Voltage ( <b>Red</b> )	6.3	7.0	7.9	V
	Forward Voltage ( <b>Red/Green/Blue</b> )	9.0	9.7	10.7	V
	Forward Voltage ( <b>White</b> )	9.5	10.2	11.2	V
	$V_F$ Temperature Co-efficient ( <b>Amber, Red</b> )	----	-6.0	----	mV/°C
	$V_F$ Temperature Co-efficient ( <b>White, Blue</b> )	----	-4.8	----	mV/°C
	$V_F$ Temperature Co-efficient ( <b>Green</b> )	----	-5.0	----	mV/°C
2 $\Theta_{1/2}$	50% Power Angle	----	120	----	deg

## Optical Characteristics ( $I_F = 1.05 \text{ A}$ , $T_J = 25^\circ \text{ C}$ , 2 $\Theta_{1/2} = 120^\circ$ )

COLOR	DOMINANT WAVELENGTH			SPECTRAL FULL-WIDTH-HALF-MAXIMUM	DOMINANT WAVELENGTH TEMPERATURE DEPENDENCE
	MIN	TYP	MAX		
Amber	590	595	600	16 nm	0.08 nm/°C
Blue	457	460	463	24 nm	0.05 nm/°C
Green	520	525	530	40 nm	0.04 nm/°C
Red	620	625	630	18 nm	0.05 nm/°C
White	N/A	N/A	N/A	N/A	N/A

## Critical Thermal Conditions (To maintain junction temperature ( $T_J$ ) at 85 °C)

	WHEN MOUNTED ON:				
	FR4 PC BOARD	IMS	ANOTHERM PLATE	ANOTHERM EXTRUSION	ACTIVE HEATSINK
USE SAFE OPERATING CURRENT OF:	200 mA	500 mA	700 mA	800 mA	1000 mA

**NOTE:** Refer to OPTEK Application Note #228 on thermal management ([www.optekinc.com/pdf/AppNote228.pdf](http://www.optekinc.com/pdf/AppNote228.pdf)).

OPTEK reserves the right to make changes at any time in order to improve design and to supply the best product possible.

CIE Chromaticity Diagram

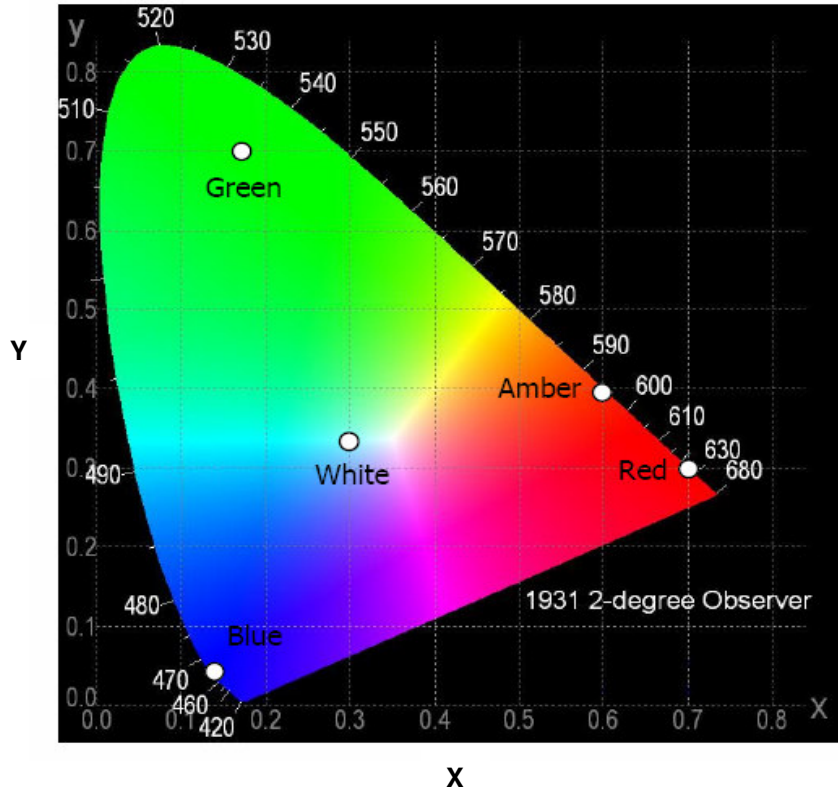

Spatial Intensity Distribution

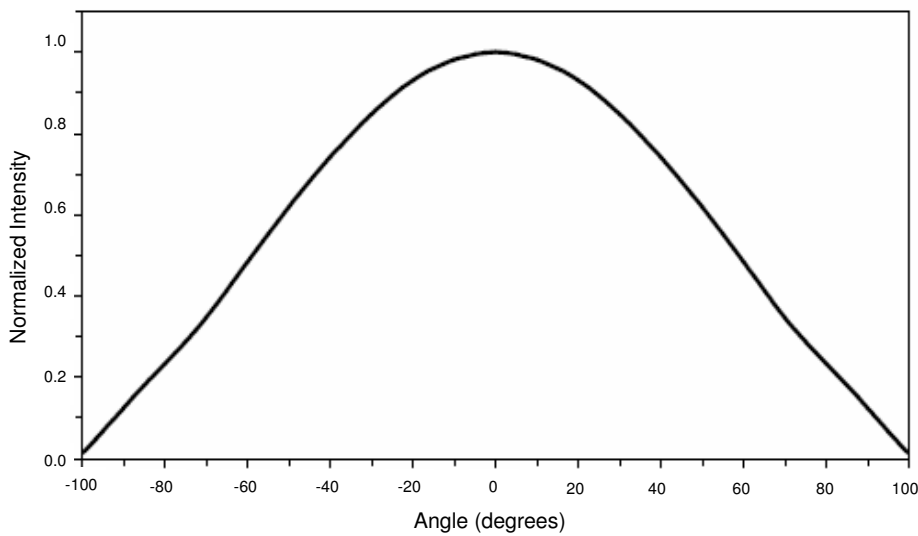

Normalized Spectral Intensity vs Angular Displacement

OPTEK reserves the right to make changes at any time in order to improve design and to supply the best product possible.

### Typical Electro-Optical Characteristics Curves

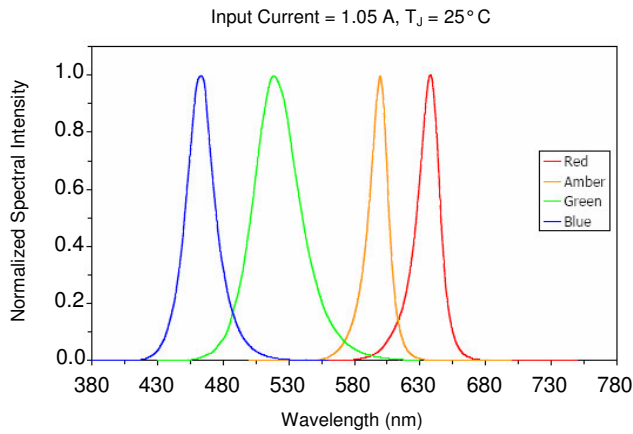

Wavelength Characteristics

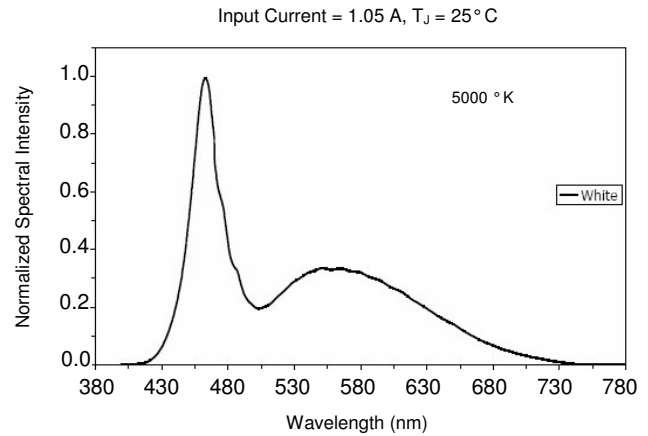

Wavelength Characteristics

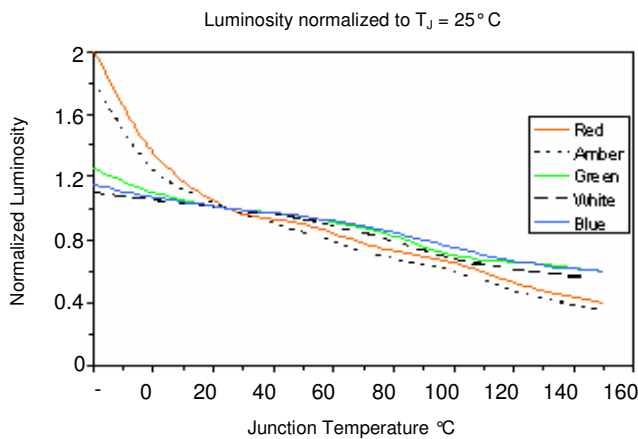

Junction Temperature Characteristics

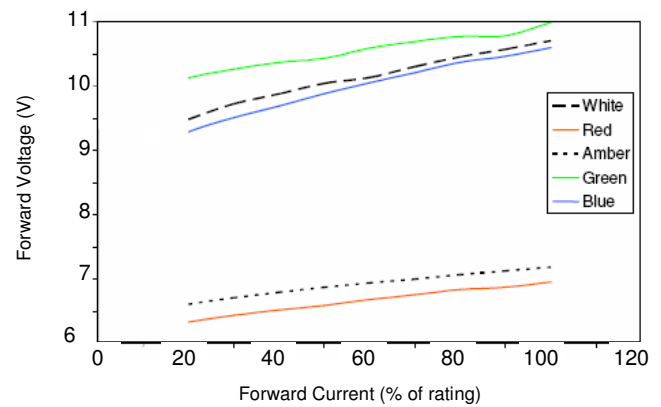

Forward Current Characteristics

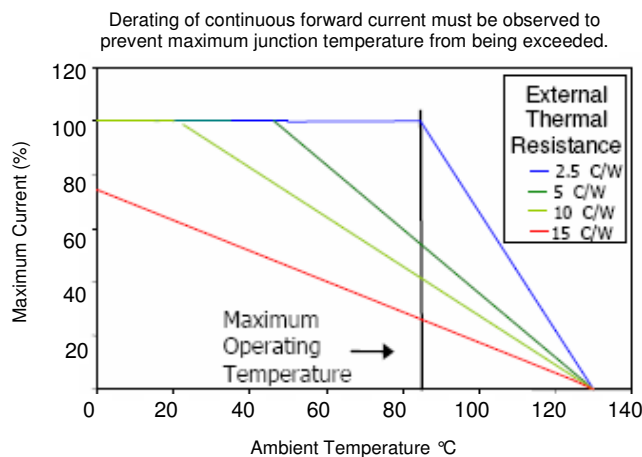

Derating Curves - Blue, Green and White LEDs

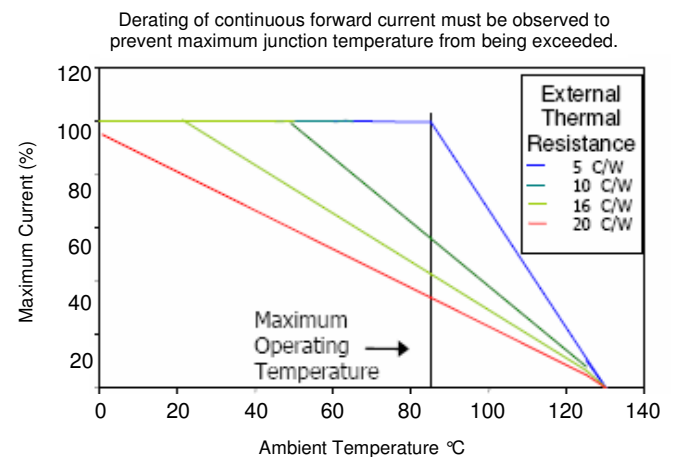

Derating Curves - Amber and Red LEDs

OPTeK reserves the right to make changes at any time in order to improve design and to supply the best product possible.

# 10-Watt Lednium SMD

## OVTL09LGx Series

### OPTEK Lednium Turtle Markings

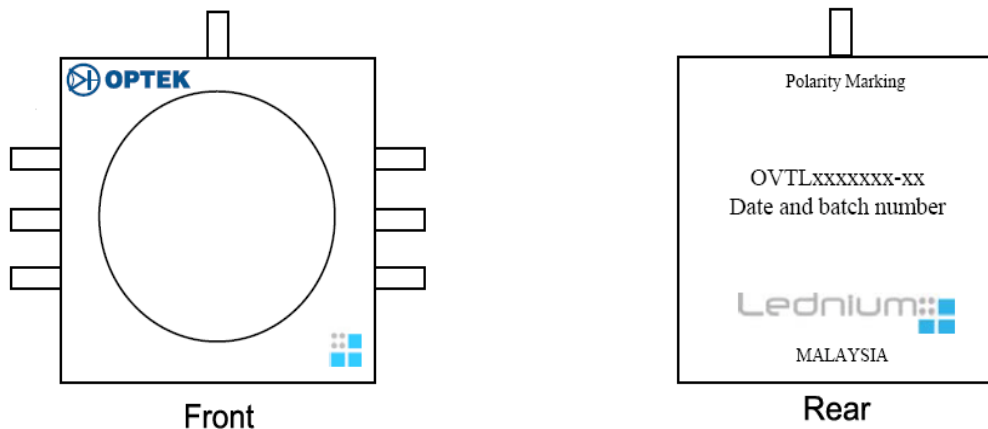

Packaging: 25 pieces per tray

**OPTEK's Lednium Series Solid State Lighting products package the highest quality LED chips. Typically, the lumen output of these chips can be as high as 70% after 50,000 hours of operation. This prediction is based on specific test results and on tests on similar materials, and relies on strict observation of the design limits and ratings included in this data sheet.**

OPTEK reserves the right to make changes at any time in order to improve design and to supply the best product possible.