



ATTENTION
OBSERVE PRECAUTIONS
FOR HANDLING
ELECTROSTATIC
DISCHARGE
SENSITIVE
DEVICES

Features

- White SMD package, silicone resin.
- Low thermal resistance.
- Compatible with IR-reflow processes.
- ESD protection.
- Package: 2000pcs / reel.
- Moisture sensitivity level : level 2a.
- RoHS compliant.

Description

The source color devices are made with AlGaInP Light Emitting Diode.

Static electricity and surge damage the LEDs.

It is recommended to use a wrist band or anti-electrostatic glove when handling the LEDs.

All devices, equipment and machinery must be electrically grounded.

Applications

- Signal and symbol luminaire for orientation.
- Marker lights (e.g. steps, exit ways, etc).
- Decorative and entertainment lighting.
- Commercial and residential lighting.
- Automotive interior lighting.

Package Dimensions

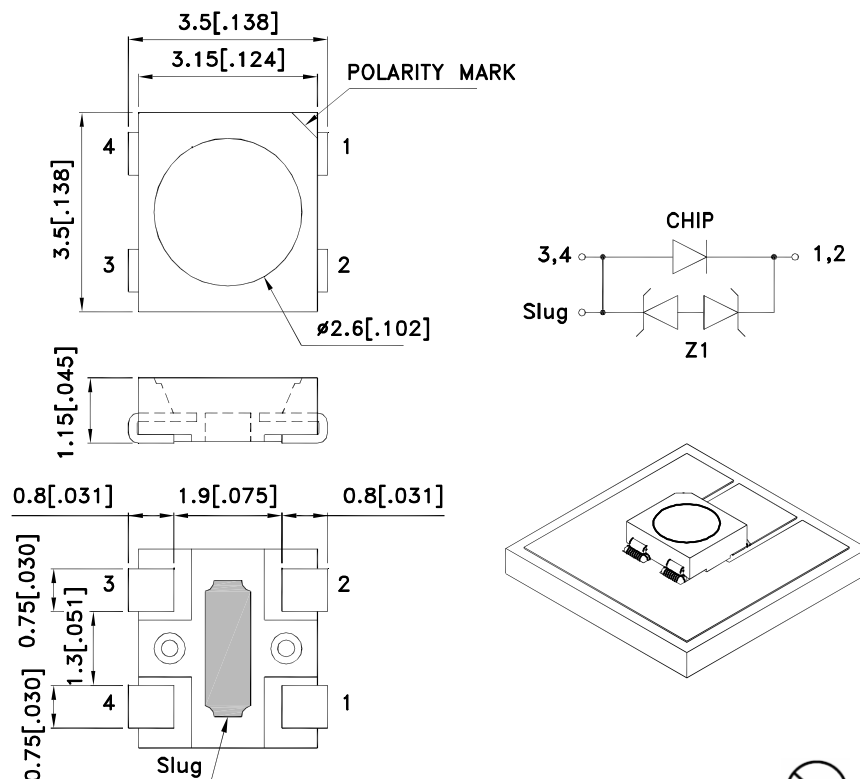

Notes:

1. All dimensions are in millimeters (inches).
2. Tolerance is $\pm 0.25(0.01)$ unless otherwise noted.
3. The specifications, characteristics and technical data described in the datasheet are subject to change without prior notice.
4. The device has a single mounting surface. The device must be mounted according to the specifications.



Handling Precautions

Compare to epoxy encapsulant that is hard and brittle, silicone is softer and flexible. Although its characteristic significantly reduces thermal stress, it is more susceptible to damage by external mechanical force.

As a result, special handling precautions need to be observed during assembly using silicone encapsulated LED products. Failure to comply might lead to damage and premature failure of the LED.

1. Handle the component along the side surfaces by using forceps or appropriate tools.

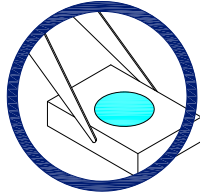

2. Do not directly touch or handle the silicone lens surface. It may damage the internal circuitry.

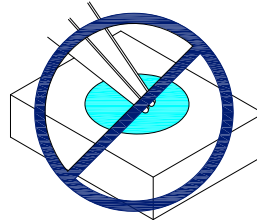
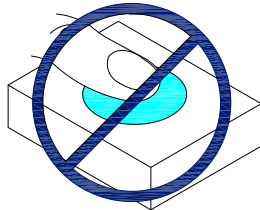

3. Do not stack together assembled PCBs containing exposed LEDs. Impact may scratch the silicone lens or damage the internal circuitry.

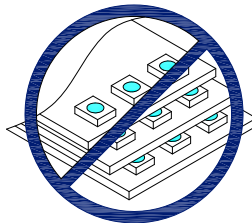

4. The outer diameter of the SMD pickup nozzle should not exceed the size of the LED to prevent air leaks. The inner diameter of the nozzle should be as large as possible.
5. A pliable material is suggested for the nozzle tip to avoid scratching or damaging the LED surface during pickup.
6. The dimensions of the component must be accurately programmed in the pick-and-place machine to insure precise pickup and avoid damage during production.

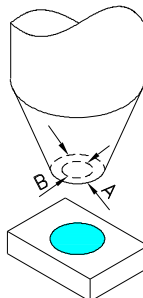

Selection Guide

Part No.	Dice	Lens Type	Iv (cd) [2] @ 150mA		Φv (lm) [2] @ 150mA		Viewing Angle [1]
			Min.	Typ.	Min.	Typ.	2 θ 1/2
AA3535SYL1Z1S	Super Bright Yellow(AIGaInP)	WATER CLEAR	2.8	4	6	8	120 °

Notes:

1. θ1/2 is the angle from optical centerline where the luminous intensity is 1/2 of the optical peak value.
2. Luminous intensity/ luminous Flux: +/-15%.

Absolute Maximum Ratings at TA=25°C

Parameter	Symbol	Value	Unit
Power Dissipation	P _D	525	mW
Junction Temperature [1]	T _J	130	°C
Operating Temperature	T _{op}	-40 To +85	°C
Storage Temperature	T _{stg}	-40 To +85	°C
DC Forward Current [1]	I _F	150	mA
Reverse Voltage	V _R	5	V
Peak Forward Current [2]	I _{FM}	270	mA
Thermal Resistance [1] (Junction/ambient)	R _{thj-a}	178	°C/W
Thermal Resistance [1] (Junction/solder point)	R _{thj-s}	78	°C/W
Electrostatic Discharge Threshold (HBM)		8000	V

Notes:

1. Results from mounting on PC board FR4 (pad size ≥ 70mm²), mounted on pc board-metal core PCB is recommend for lowest thermal Resistance.
2. 1/10 Duty Cycle, 0.1ms Pulse Width.

Electrical / Optical Characteristics at TA=25°C

Parameter	Symbol	Value	Unit
Wavelength at peak emission I _F =150mA [Typ.]	λ peak	590	nm
Dominant Wavelength I _F =150mA [Typ.]	λ dom [1]	590	nm
Spectral Line Half-width I _F =150mA [Typ.]	Δλ	20	nm
Forward Voltage I _F =150mA [Min.]	V _F [2]	2.5	V
Forward Voltage I _F =150mA [Typ.]		3.0	
Forward Voltage I _F =150mA [Max.]		3.5	
Reverse Current (V _R = 5V) [Max.]	I _R	10	uA
Temperature coefficient of λ peak I _F =150mA, -10 ° C ≤ T ≤ 100 ° C [Typ.]	TC λ peak	0.13	nm/° C
Temperature coefficient of λ dom I _F =150mA, -10 ° C ≤ T ≤ 100 ° C [Typ.]	TC λ dom	0.10	nm/° C
Temperature coefficient of V _F I _F =150mA, -10 ° C ≤ T ≤ 100 ° C [Typ.]	TC _V	-3.3	mV/° C

Notes:

1. Wavelength: +/-1nm.
2. Forward Voltage: +/-0.1V.

Super Bright Yellow

AA3535SYL1Z1S

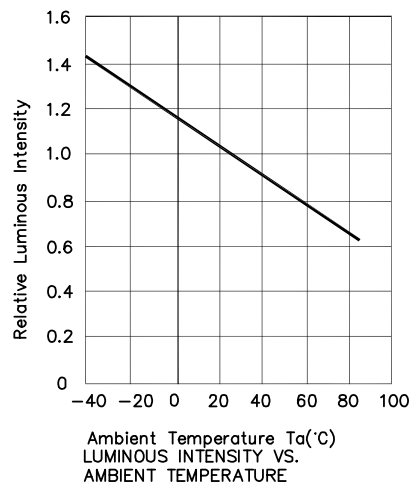
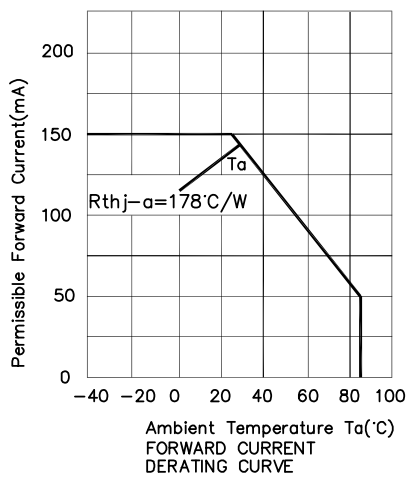
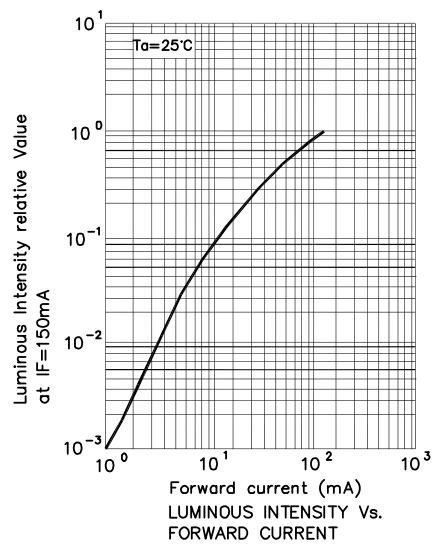
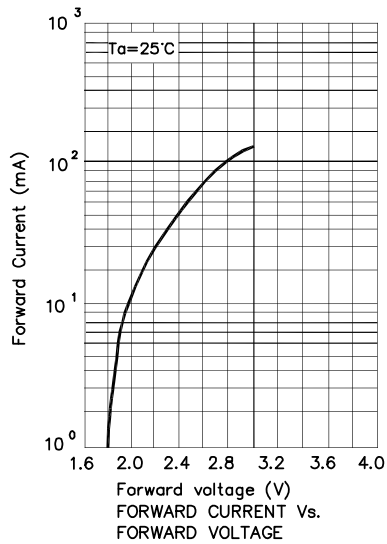
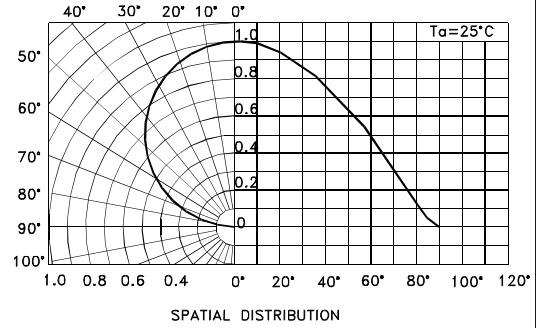
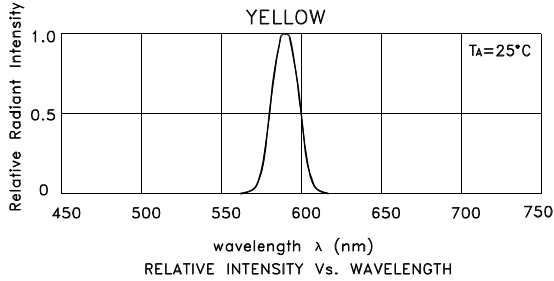

AA3535SYL1Z1S

Reflow soldering is recommended and the soldering profile is shown below.
Other soldering methods are not recommended as they might cause damage to the product.

Reflow Soldering Profile For Lead-free SMT Process.

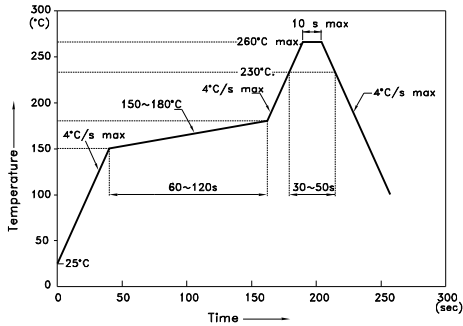

NOTES:

1. We recommend the reflow temperature 245°C(+/-5°C). The maximum soldering temperature should be limited to 260°C.
2. Don't cause stress to the epoxy resin while it is exposed to high temperature.
3. Number of reflow process shall be 2 times or less.

Reel Dimension

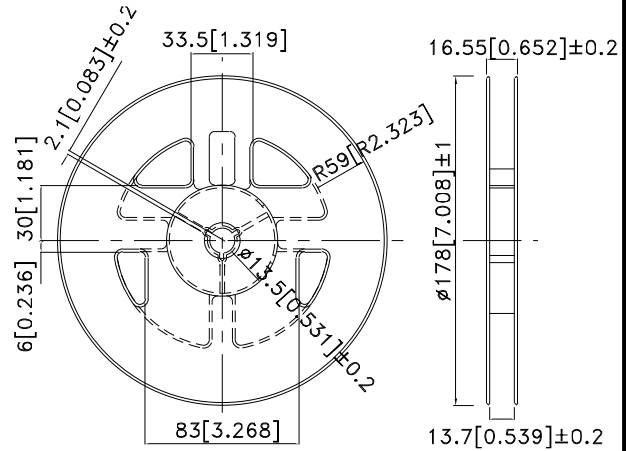

Recommended Soldering Pattern (Units : mm; Tolerance: ±0.1)

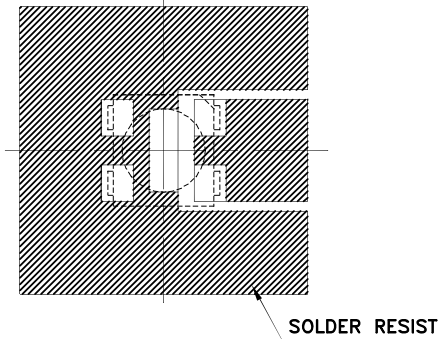
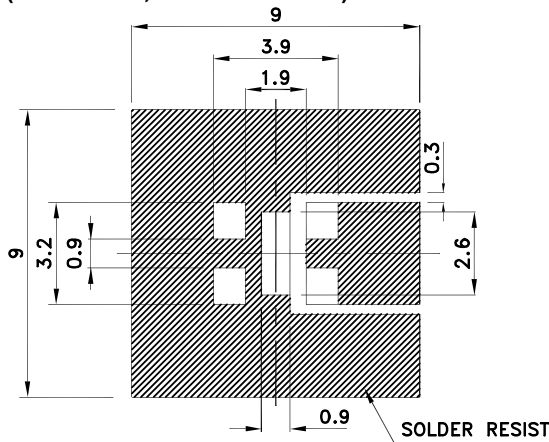

Tape Specifications (Units : mm)

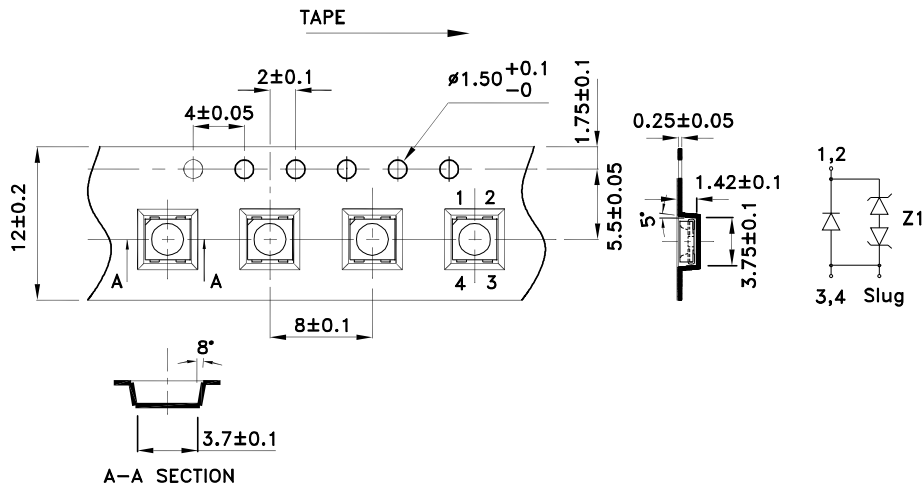

PACKING & LABEL SPECIFICATIONS

AA3535SYL1Z1S

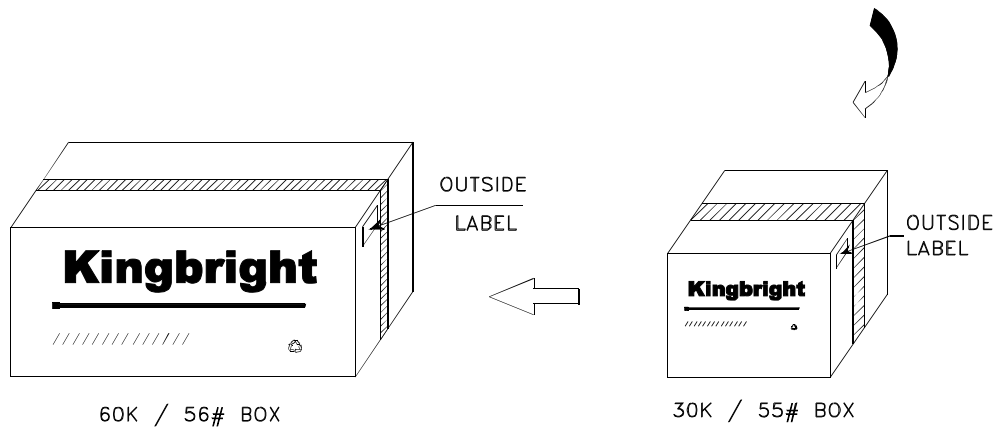
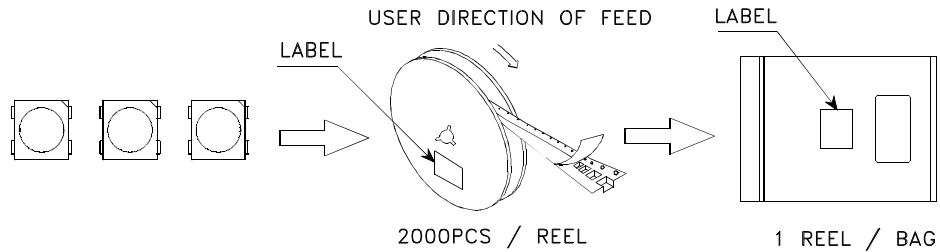

<h2 style="margin: 0;">Kingbright</h2>	
P/NO: AA3535xxx	
QTY: 2000 pcs	Q.C.
S/N: XXXX	<div style="border: 1px solid black; border-radius: 50%; padding: 5px; display: inline-block;"> Q C XX XX XXXX PASSED </div>
CODE: XXX	
LOT NO:	
RoHS Compliant	