

Lednium Series Optimal I

Flush Mount and Surface Mount Packages

OVTL01LGAx Series

- Robust energy-efficient design with long operating life
- Low thermal resistance (2° C/W)
- Exceptional spatial uniformity
- Available in amber, blue, cyan, green, red, cool white, daylight white, and warm white

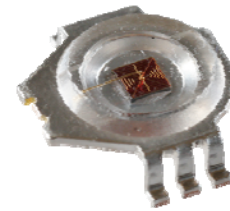

The **OVTL01LGAx Series** offers an energy-efficient packaged LED source providing high luminance, low thermal resistance, a water-clear lens, and a long operating lifespan. Devices have a 135° typical viewing angle with optional optics available and two mounting options:

1. Flush Mount—The shallow-gullwing package is designed to be countersunk into a hole or cavity in the PC board for a low profile of only 1.12mm.
2. Surface Mount—The deep-gullwing package is easily mounted on the solid surface of the PC board (Part numbers end in “S”)

Applications

- Automotive exterior and interior lighting
- Architectural lighting
- Electronic signs and signals

| Part Number | Viewing Angle | Emitted Color | Typical Luminous Flux (lm) | Package |
|--------------|---------------|----------------|----------------------------|---------------|
| OVTL01LGAA | 135° | Amber | 35 | Flush Mount |
| OVTL01LGAB | | Blue | 12 | Flush Mount |
| OVTL01LGAC | | Cyan | 40 | Flush Mount |
| OVTL01LGAG | | Green | 60 | Flush Mount |
| OVTL01LGAR | | Red | 45 | Flush Mount |
| OVTL01LGAW | | Cool White | 65 | Flush Mount |
| OVTL01LGAWD | | Daylight White | 60 | Flush Mount |
| OVTL01LGAWW | | Warm White | 50 | Flush Mount |
| OVTL01LGAAS | | Amber | 35 | Surface Mount |
| OVTL01LGABS | | Blue | 12 | Surface Mount |
| OVTL01LGACS | | Cyan | 40 | Surface Mount |
| OVTL01LGAGS | | Green | 60 | Surface Mount |
| OVTL01LGARS | | Red | 45 | Surface Mount |
| OVTL01LGAWS | | Cool White | 65 | Surface Mount |
| OVTL01LGAWDS | | Daylight White | 60 | Surface Mount |
| OVTL01LGAWWS | | Warm White | 50 | Surface Mount |



DO NOT LOOK DIRECTLY AT LED WITH UNSHIELDED EYES OR DAMAGE TO RETINA MAY OCCUR.

OPTEK reserves the right to make changes at any time in order to improve design and to supply the best product possible.

Lednium Series Optimal I

OVTL01LGA Series

Package Drawing:

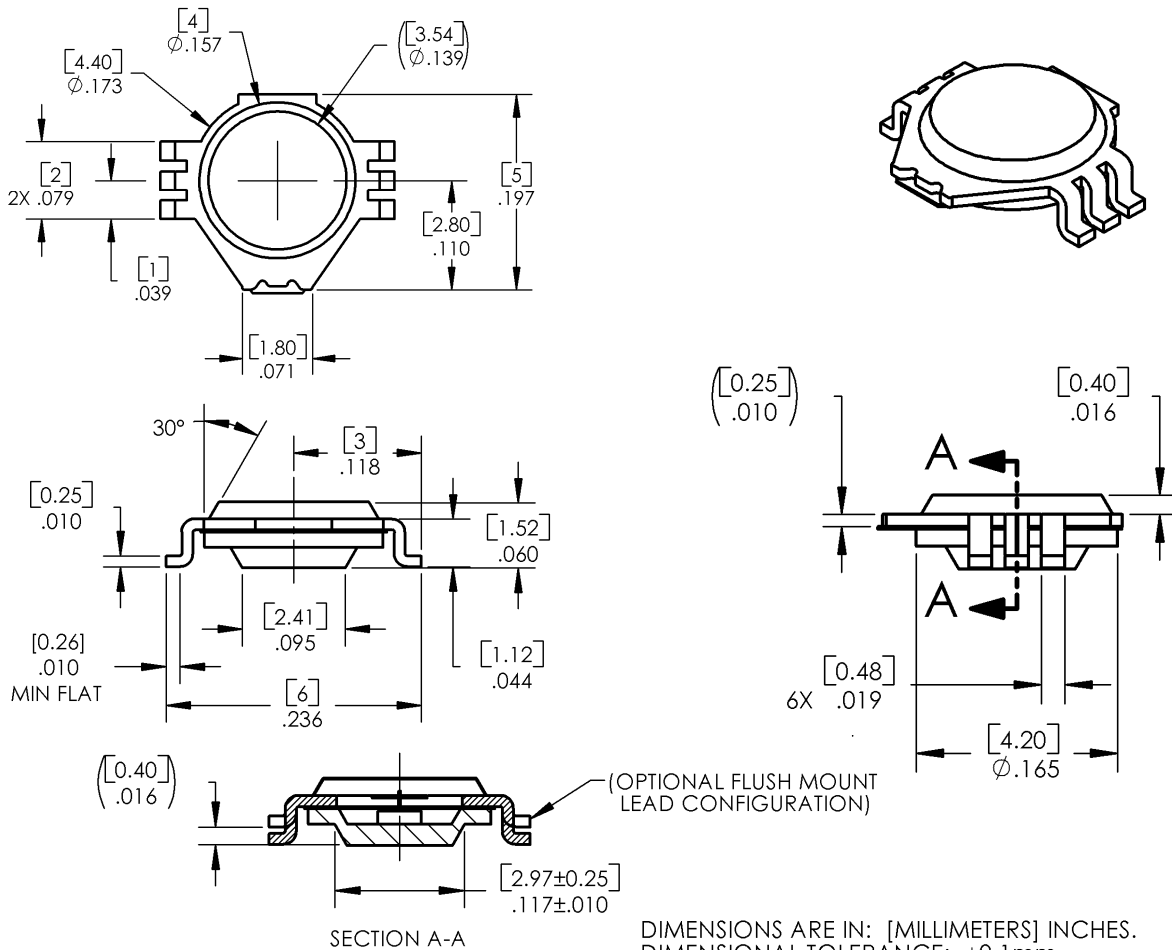

FLUSH MOUNT Recommended Solder Pattern

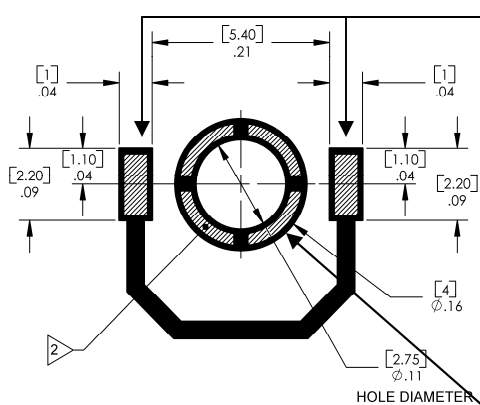

SURFACE MOUNT Recommended Solder Pattern

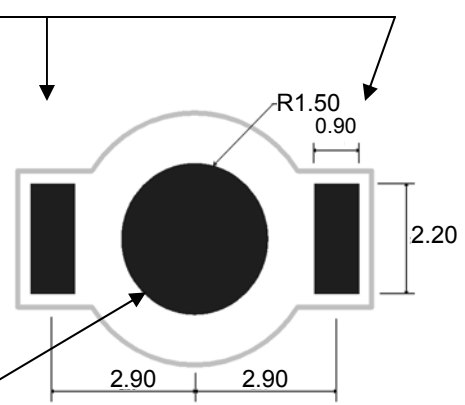

1. Recommend .006 [015] thick stencil.
2. Cross-hatching represents solder paste positioning
3. Dimensions are in inches [mm]

OPTeK reserves the right to make changes at any time in order to improve design and to supply the best product possible.

Lednium Series Optimal I

OVTL01LGA Series



Absolute Maximum Ratings

| | |
|---|---------------|
| DC Forward Current | 0.35 A |
| Peak Pulsed Forward Current ¹ | 1 A |
| Reverse Voltage | 5 V |
| Maximum Allowable Junction Temperature ² | 130° C |
| Storage and Operating Temperature | -50° ~ +85° C |

Notes:

1. Pulse width 1 ms maximum. Duty cycle 1/16.
2. Thermal Resistance junction to Board ($T_{j\theta}$) is 2° C/W, see Application Bulletin 238

Electrical Characteristics ($I_F = 350$ mA, $T_J = 25^\circ$ C)

| SYMBOL | PARAMETER | MIN | TYP | MAX | UNITS |
|--------|--|------|------|------|-------|
| V_F | Forward Voltage (Amber) | 1.9 | 2.3 | 2.6 | V |
| | Forward Voltage (Blue) | 2.9 | 3.4 | 3.7 | V |
| | Forward Voltage (Cyan & Green) | 2.9 | 3.4 | 3.7 | V |
| | Forward Voltage (Red) | 1.9 | 2.3 | 2.6 | V |
| | Forward Voltage (White) | 2.9 | 3.4 | 3.7 | V |
| | $V_{F_}$ Temperature Co-efficient (Amber & Red) | ---- | -6.0 | ---- | mV/°C |
| | $V_{F_}$ Temperature Co-efficient (White & Blue) | ---- | -4.8 | ---- | mV/°C |
| | $V_{F_}$ Temperature Co-efficient (Cyan & Green) | ---- | -5.0 | ---- | mV/°C |

Optical Characteristics ($I_F = 350$ mA, $T_J = 25^\circ$ C)

| COLOR | DOMINANT WAVELENGTH | | | SPECTRAL FULL-WIDTH HALF-MAXIMUM | DOMINANT WAVELENGTH TEMPERATURE DEPENDENCE |
|-------|---------------------|-----|-----|----------------------------------|--|
| | MIN | TYP | MAX | | |
| Amber | 590 | 595 | 600 | 16 nm | 0.08 nm/° C |
| Blue | 455 | 460 | 465 | 24 nm | 0.05 nm/° C |
| Cyan | 500 | 505 | 510 | 37nm | 0.04 nm/° C |
| Green | 510 | 515 | 520 | 40 nm | 0.04 nm/° C |
| Red | 620 | 625 | 630 | 18 nm | 0.05 nm/° C |

| Color | Minimum CCT (°K) | Maximum CCT (°K) | Chromaticity Coordinates | | | | |
|----------------|------------------|------------------|--------------------------|------|------|------|------|
| Cool White | 6400 | 7600 | C_x | .298 | .304 | .316 | .313 |
| | | | C_y | .314 | .297 | .318 | .34 |
| Daylight White | 5200 | 6400 | C_x | .313 | .317 | .336 | .338 |
| | | | C_y | .341 | .313 | .345 | .382 |
| Warm White | 3200 | 3800 | C_x | .388 | .403 | .440 | .419 |
| | | | C_y | .375 | .424 | .440 | .391 |

OPTEK's Lednium Series Solid State Lighting products package the highest quality LED chips. Typically, the lumen output of these can be as high as 70% after 50,000 hours of operation. This prediction is based on specific test results and on tests on similar materials, and relies on strict observation of the design limits and ratings included in this data sheet.

OPTEK reserves the right to make changes at any time in order to improve design and to supply the best product possible.

Lednium Series Optimal I

OVTL01LGA Series



Standard Bins

Lamps are sorted to luminous flux (Φ) and forward voltage (V_F) bins shown. Orders may be filled with any or all bins contained as below.

OVTL01LGAA and OVTL01LGAAS (AMBER) ($I_F = 350$ mA)

Dominant Wavelength 590-600nm

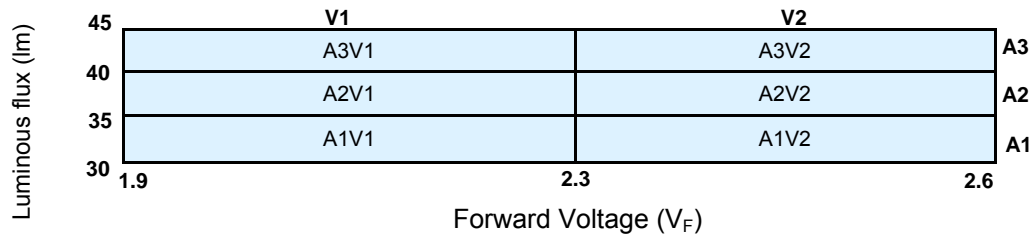

OVTL01LGAB and OVTL01LGABS (BLUE) ($I_F = 350$ mA)

Dominant Wavelength 455-465nm

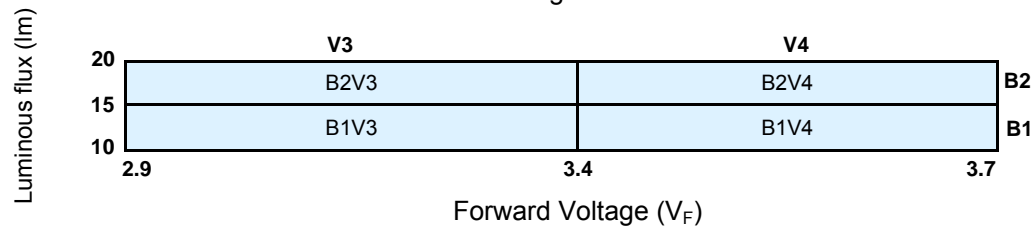

OVTL01LGAC and OVTL01LGACS (CYAN) ($I_F = 350$ mA)

Dominant Wavelength 500-510nm

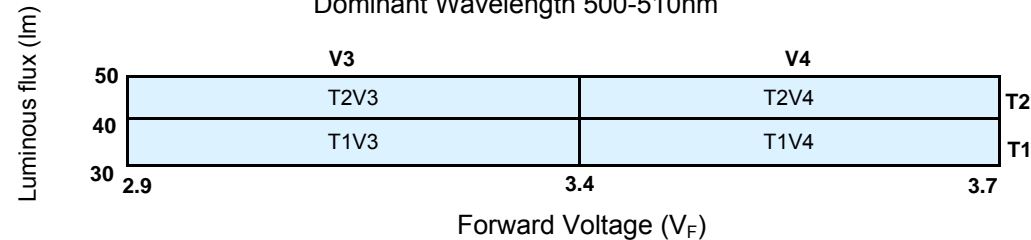

OVTL01LGAG and OVTL01LGAGS (GREEN) ($I_F = 350$ mA)

Dominant Wavelength 510-520nm

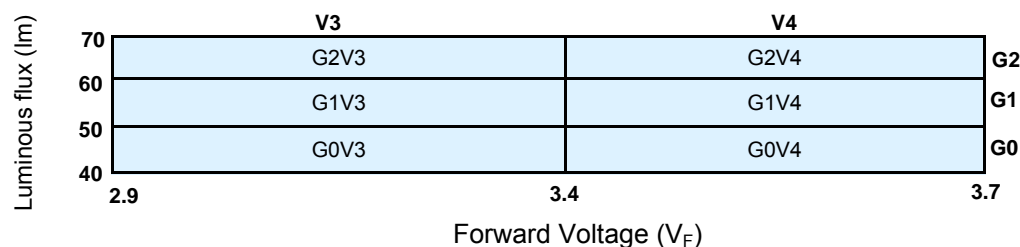

Important Notes:

1. All ranks will be included per delivery, rank ratio will be based on the chip distribution.
2. To designate forward voltage and luminous flux ranks, please contact OPTeK.

OPTeK reserves the right to make changes at any time in order to improve design and to supply the best product possible.

Lednium Series Optimal I

OVTL01LGA Series

Standard Bins

Lamps are sorted to luminous flux (Φ) and forward voltage (V_F) bins shown. Orders may be filled with any or all bins contained as below.

OVTL01LGAR and OVTL01LGARS (RED) ($I_F = 350$ mA)

Dominant Wavelength 620-630nm

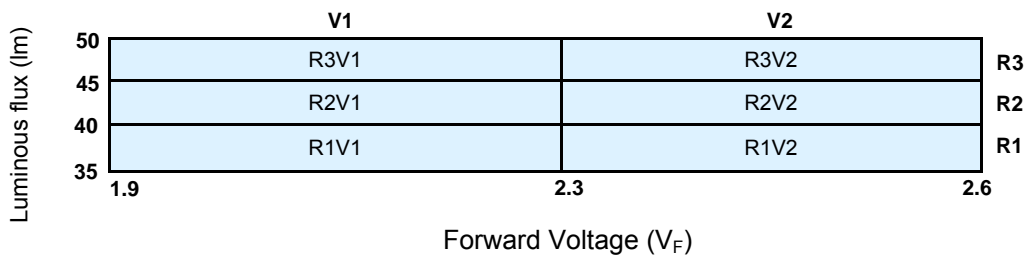

OVTL01LGAW and OVTL01LGAWS (COOL WHITE) ($I_F = 350$ mA)

Typical CCT 7000°K ($\pm 600^\circ$ K)

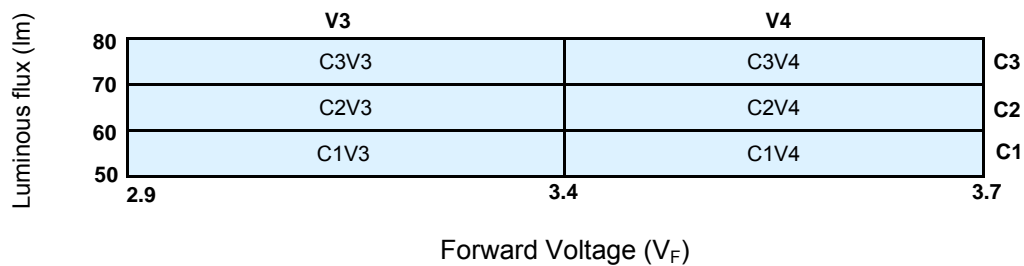

OVTL01LGAWD and OVTL01LGAWDS (DAYLIGHT WHITE) ($I_F = 350$ mA)

Typical CCT 5800°K ($\pm 600^\circ$ K)

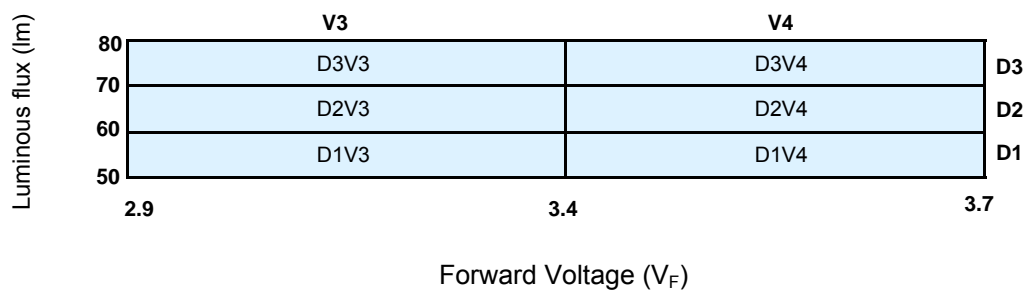

OPTEK reserves the right to make changes at any time in order to improve design and to supply the best product possible.

Lednium Series Optimal I

OVTL01LGA Series

Standard Bins

Lamps are sorted to luminous flux (Φ) and forward voltage (V_F) bins shown. Orders may be filled with any or all bins contained as below.

OVTL01LGAWW and OVTL01LGAWWS (WARM WHITE) ($I_F = 350$ mA)

Typical CCT 3500°K ($\pm 300^\circ$ K)

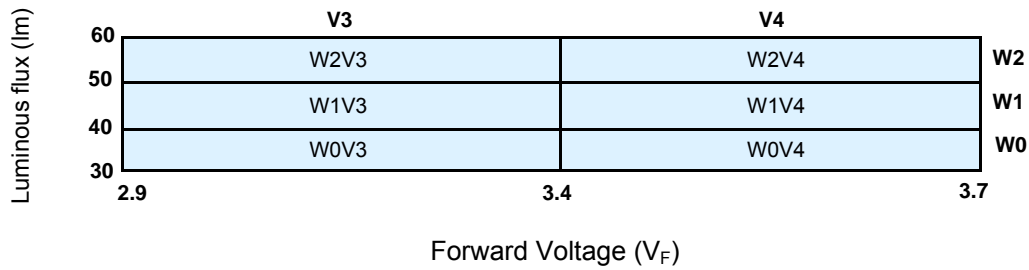

White Color Bins

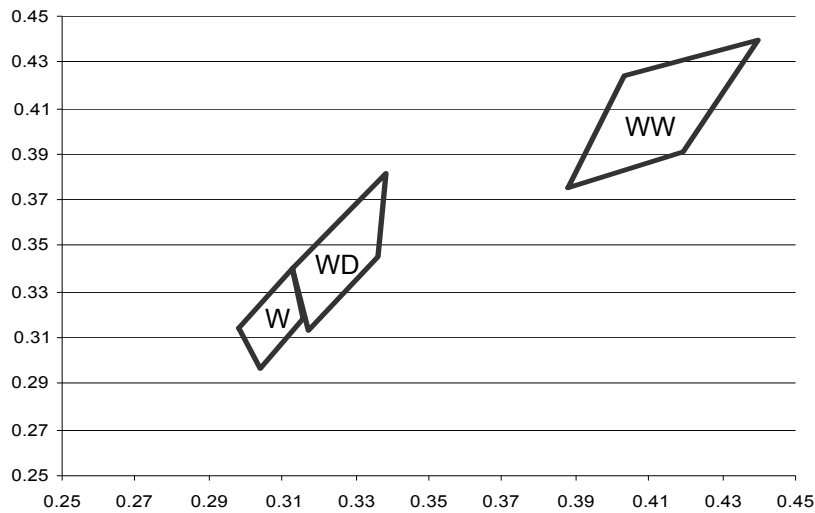

| | Color | CCT |
|-----------|----------------|------------------|
| W | Cool White | 7000°K \pm 600 |
| WD | Daylight White | 5800°K \pm 600 |
| WW | Warm White | 3500°K \pm 300 |

OPTEK reserves the right to make changes at any time in order to improve design and to supply the best product possible.

CIE Chromaticity Diagram

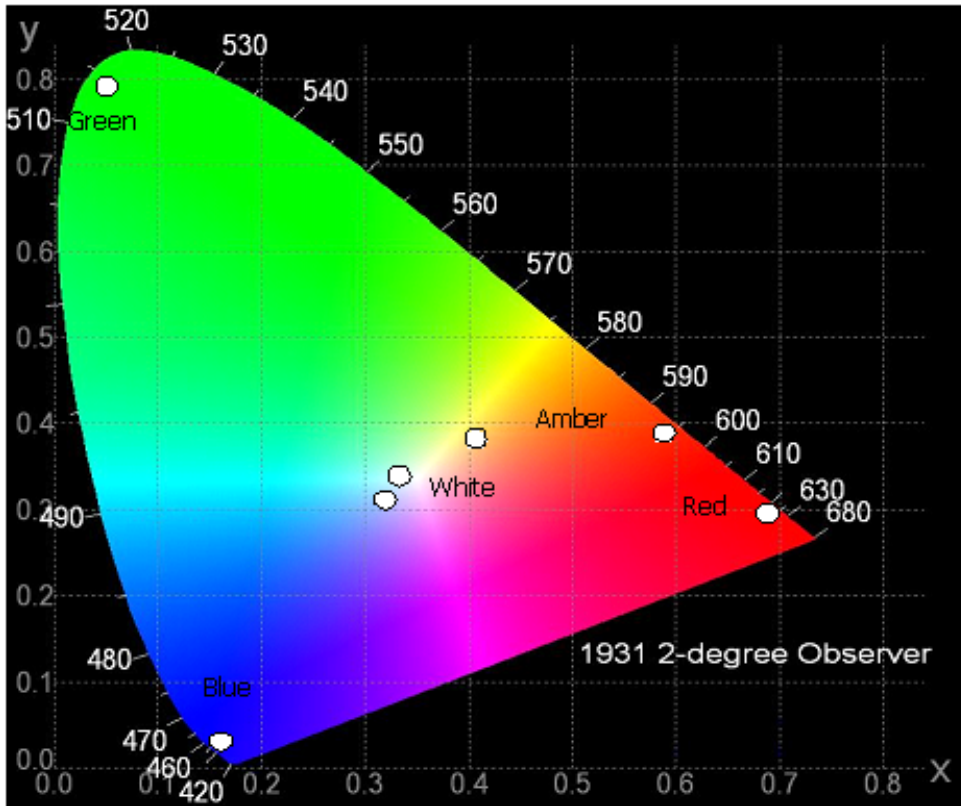

Spatial Intensity Distribution

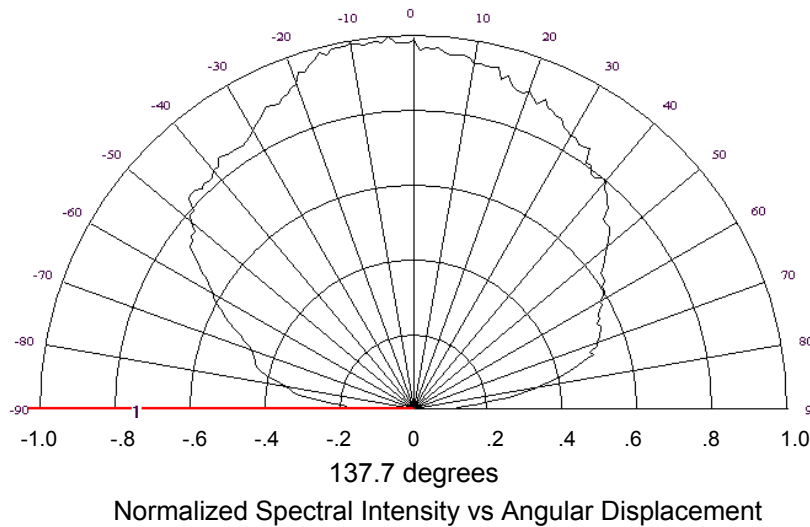

OPTEK reserves the right to make changes at any time in order to improve design and to supply the best product possible.

Typical Electro-Optical Characteristics Curves

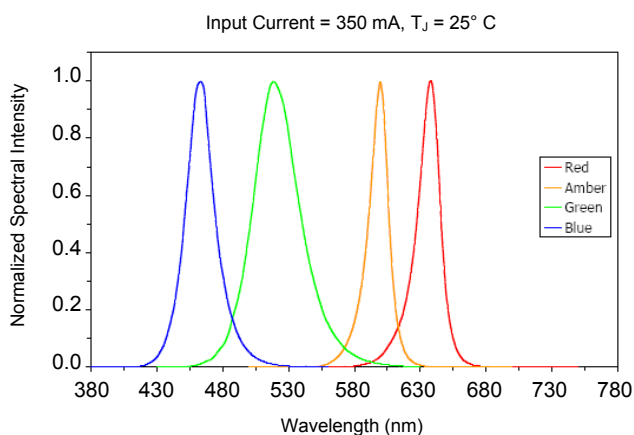

Wavelength Characteristics

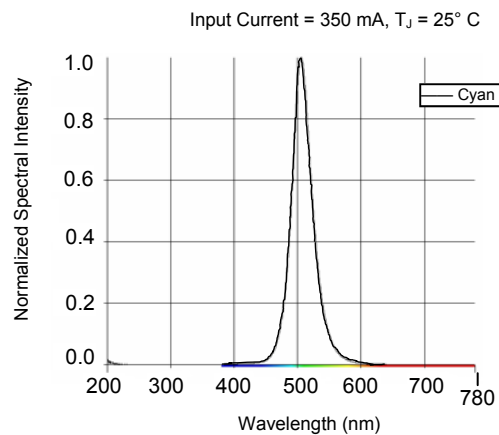

Wavelength Characteristics

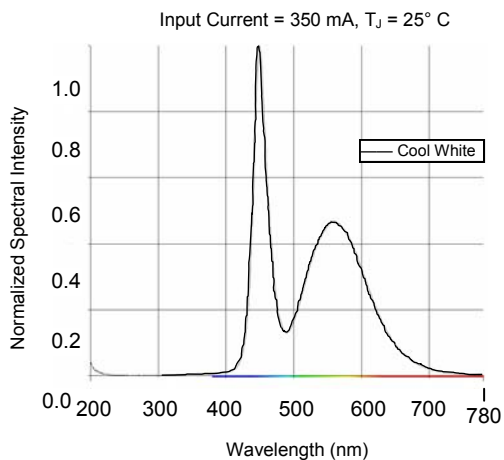

Wavelength Characteristics

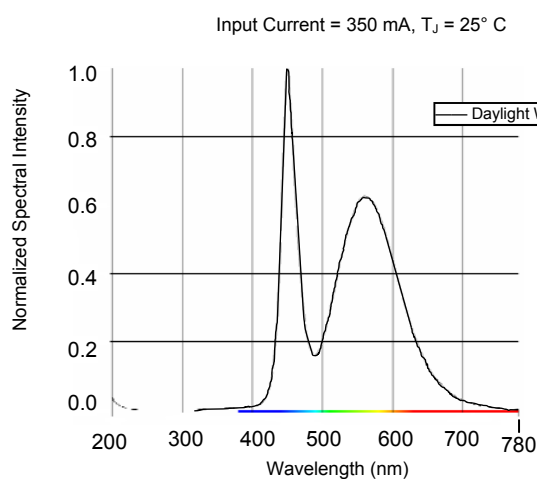

Wavelength Characteristics

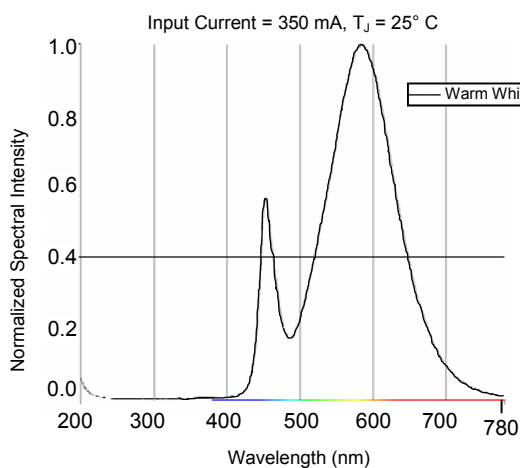

Wavelength Characteristics

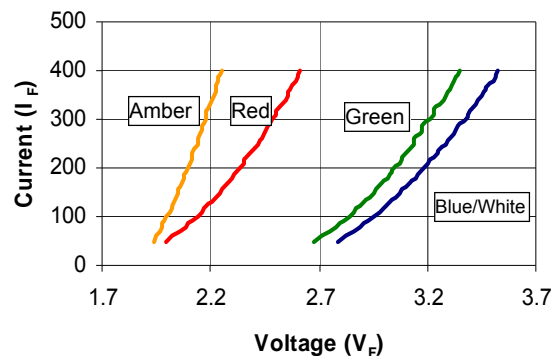

Forward Current vs. Forward Voltage

OPTeK reserves the right to make changes at any time in order to improve design and to supply the best product possible.

Typical Electro-Optical Characteristics Curves

Luminosity normalized to $T_J = 25^\circ\text{C}$

| OPTeK Part Number | % Normalized Luminosity at Junction Temperature ($^\circ\text{C}$) | | | | | |
|-------------------|--|-----|----|----|-----|-----|
| | 0 | 25 | 50 | 75 | 100 | 125 |
| OVTLO1LGAA(S) | 125 | 100 | 85 | 70 | 60 | 45 |
| OVTLO1LGAB(S) | 107 | 100 | 95 | 87 | 75 | 65 |
| OVTLO1LGAG(S) | 110 | 100 | 95 | 85 | 70 | 65 |
| OVTLO1LGAR(S) | 135 | 100 | 90 | 75 | 65 | 50 |
| OVTLO1LGAW(S) | 105 | 100 | 93 | 82 | 68 | 60 |
| OVTLO1LGAWD(S) | 105 | 100 | 93 | 82 | 68 | 60 |
| OVTLO1LGAWW(S) | 105 | 100 | 93 | 82 | 68 | 60 |

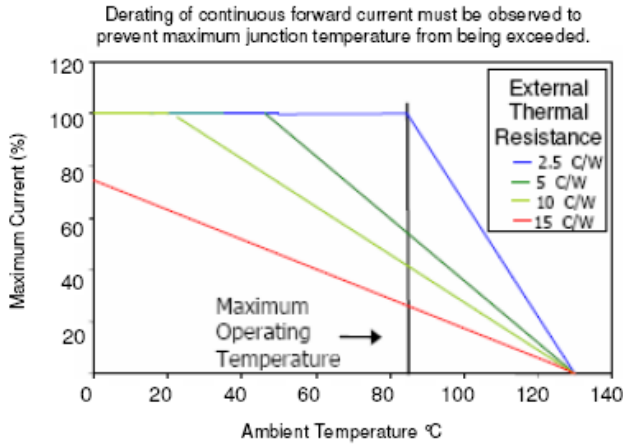
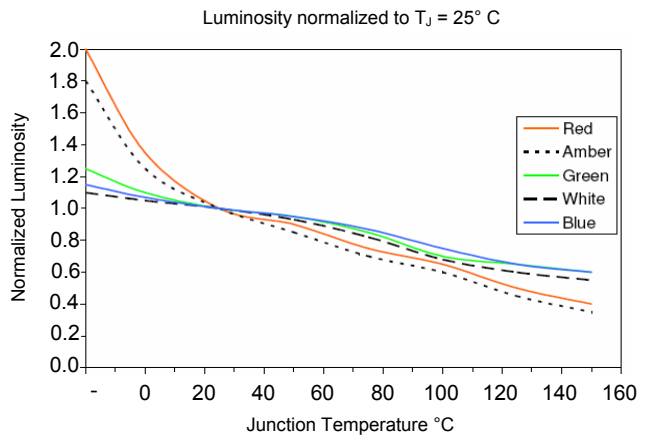

Derating Curves - Blue, Green and White LEDs

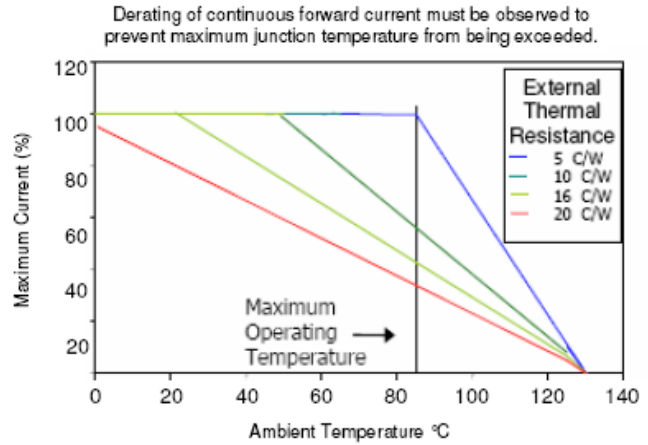

Derating Curves - Amber and Red LEDs

Solder Reflow Cycle

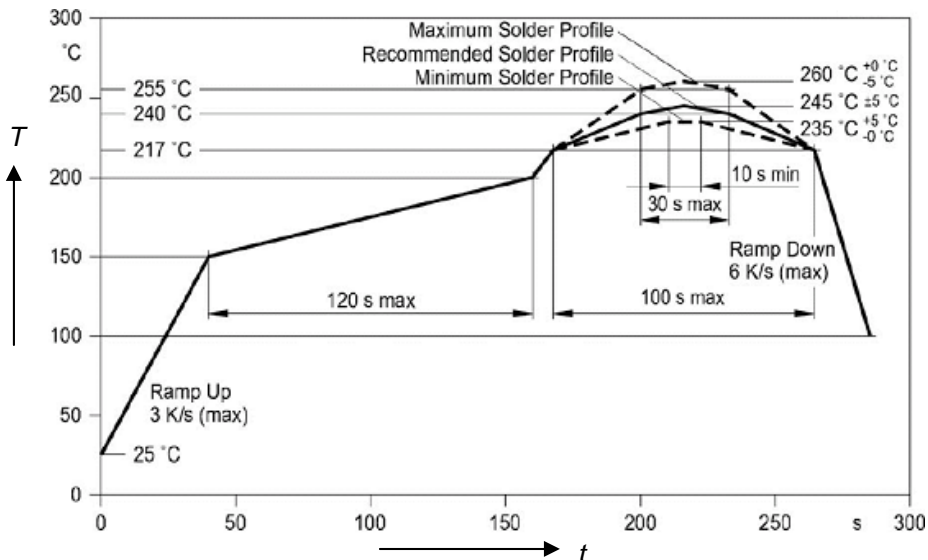

OPTeK reserves the right to make changes at any time in order to improve design and to supply the best product possible.

Lednium Series Optimal I

OVTL01LGA Series

Reel Dimensions:

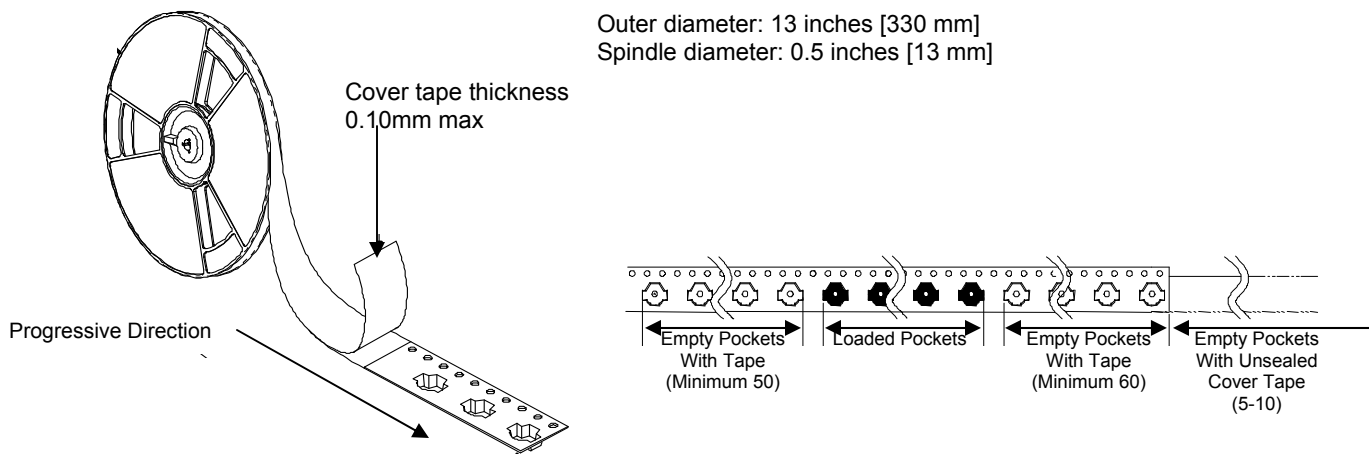

Carrier Tape Dimensions: Loaded quantity 1000 maximum pieces per reel

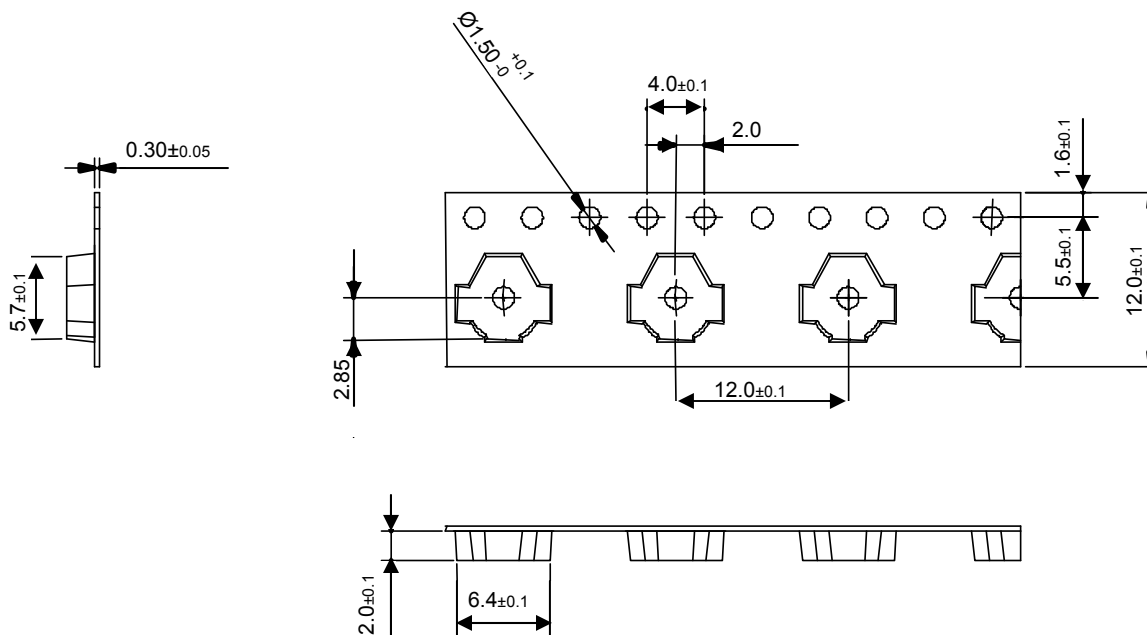

Moisture Resistant Packaging

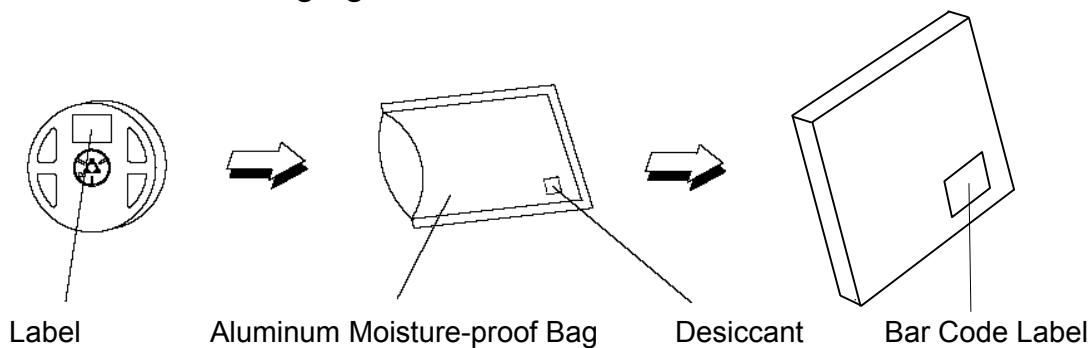

OPTeK reserves the right to make changes at any time in order to improve design and to supply the best product possible.