

XZ10150

Z1

Description

Z-Power series is designed for high current operation and high flux output applications.

Z-Power LED's thermal management perform exceeds other power LED solutions.

It incorporates state of the art SMD design and Thermal emission material.

Z Power LED is ideal light sources for general Illumination applications, custom designed solutions, automotive large LCD backlights



Features

- Super high Flux output and high Luminance
- Designed for high current operation
- Low thermal resistance
- SMT solderability
- Lead Free product
- RoHS compliant

Applications

- Mobile phone flash
- Automotive interior / exterior lighting
- Automotive signal lighting
- Automotive forward lighting
- General Torch
- Architectural lighting
- LCD TV / Monitor Backlight
- Projector light source
- Traffic signals
- Task lighting
- Decorative / Pathway lighting
- Remote / Solar powered lighting
- Household appliances

*The appearance and specifications of the product may be changed for improvement without notice.

Rev. 10

October. 2010

www.acriche.com

Full Code of Z-Power LED Series

Full code form : $X_1 X_2 X_3 X_4 X_5 X_6 X_7 - X_8 X_9 - X_{10} X_{11} X_{12} X_{13} X_{14}$

1. Part Number

- X_1 : Color
- X_2 : New Z-Power LED - 'Z'
- X_3 : New Z-Power LED series number
- X_4 : LENS type
- X_5 : Chip quantity (or Power Dissipation)
- X_6 : Package outline size
- X_7 : Type of PCB

2. Internal Number

- X_8
- X_9

3. Code Labeling

- X_{10} : Luminous flux (or Radiant flux for royal blue)
- $X_{11} X_{12} X_{13}$: Dominant wavelength (or x,y coordinates rank code)
- X_{14} : Forward voltage

4. Sticker Diagram on Reel & Aluminum Vinyl Bag

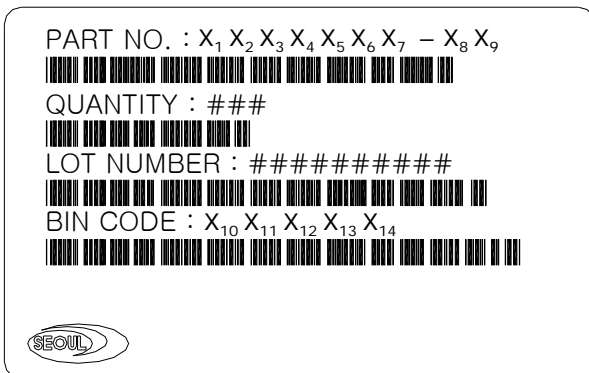

For more information about binning and labeling, refer to the Application Note -1

Rev. 10

October, 2010

www.acriche.com

Document No. : SSC-QP-7-07-24 (Rev.00)

Outline Dimension

1. Flat Type

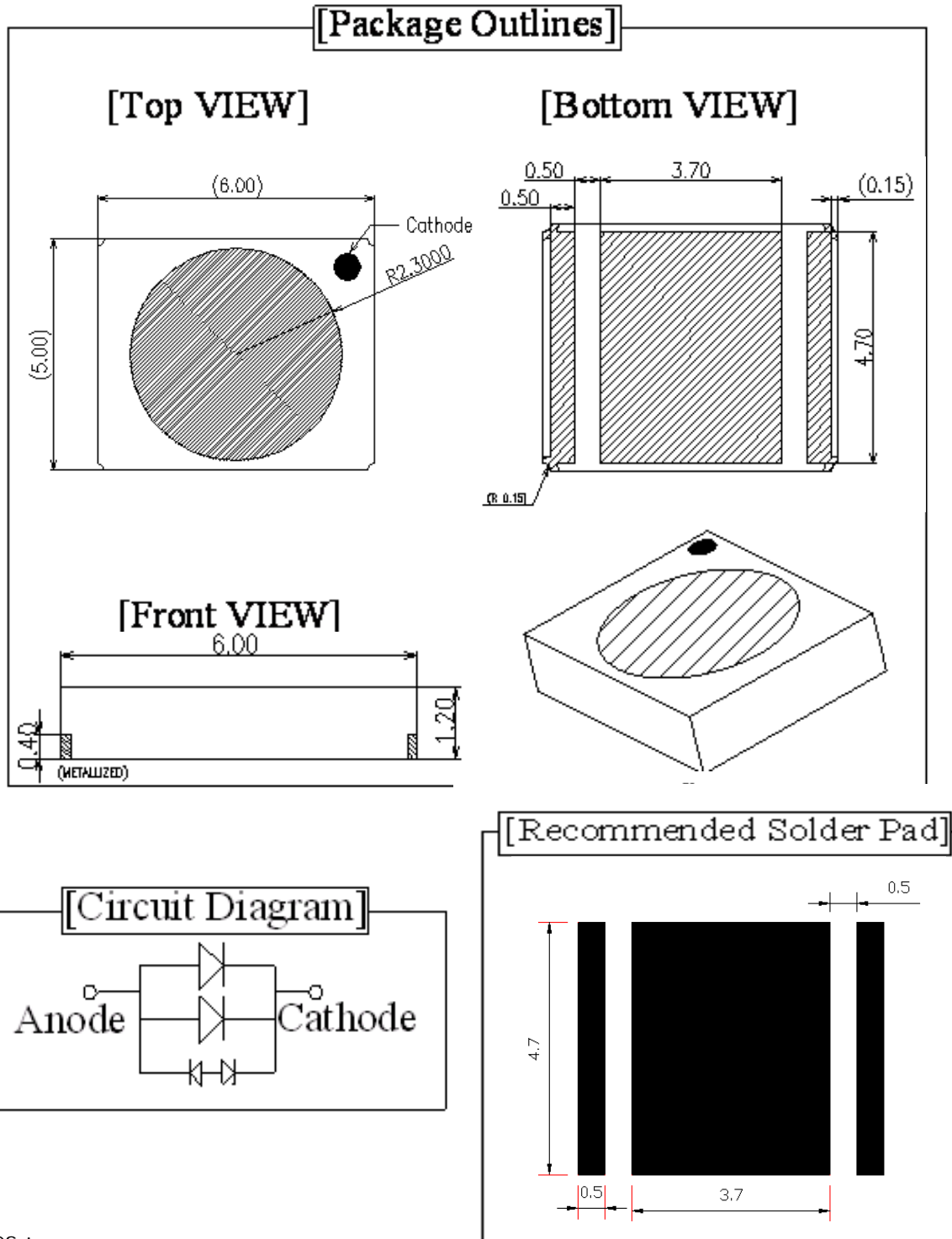

Notes :

1. All dimensions are in millimeters. (tolerance : ± 0.2)
2. Scale : none
3. Thermal pad is isolated.
4. Paste thickness: (0.2 ± 0.05) mm

*The appearance and specifications of the product may be changed for improvement without notice.

Rev. 10
October. 2010

www.acriche.com

Characteristics for Z-Power LED

1. Pure White (WZ10150)

1-1 Electro-Optical characteristics at $I_F=400\text{mA}$, $T_A=25^\circ\text{C}$

Parameter	Symbol	Value			Unit
		Min	Typ	Max	
Luminous Flux ^[1]	Φ_V ^[2]	90	100	-	lm
Correlated Color Temperature ^[3]	CCT	-	6300	-	K
CRI	R_a	-	68	-	-
Forward Voltage ^[4]	V_F	-	3.6	4.25	V
View Angle	$2\Theta \frac{1}{2}$	120			deg.
Thermal resistance ^[5]	$R\theta_{J-B}$	16.5			$^\circ\text{C} / \text{W}$
Thermal resistance ^[6]	$R\theta_{J-C}$	11.0			$^\circ\text{C} / \text{W}$

1-2 Absolute Maximum Ratings

Parameter	Symbol	Value	Unit
Forward Current	I_F	450	mA
Power Dissipation	P_d	1.67	W
Junction Temperature	T_j	125	$^\circ\text{C}$
Operating Temperature	T_{opr}	-40 ~ +85	$^\circ\text{C}$
Storage Temperature	T_{stg}	-40 ~ +100	$^\circ\text{C}$
ESD Sensitivity ^[7]	-	$\pm 10,000\text{V HBM}$	-

*Notes :

[1] SSC maintains a tolerance of $\pm 10\%$ on flux and power measurements.

[2] Φ_V is the total luminous flux output as measured with an integrated sphere.

[3] Correlated Color Temperature is derived from the CIE 1931 Chromaticity diagram.
CCT $\pm 5\%$ tester tolerance

[4] A tolerance of $\pm 0.06\text{V}$ on forward voltage measurements

[5], [6] $R\theta_{J-B}$ is measured with a SSC metal core pcb. ($25^\circ\text{C} \leq T_j \leq 110^\circ\text{C}$)

$R\theta_{J-C}$ is measured with only emitter. ($25^\circ\text{C} \leq T_j \leq 110^\circ\text{C}$)

Break voltage of Metal PCB is 6.5kVAC

[7] It is included the zener chip to protect the product from ESD.

-----Caution-----

1. Please do not drive at rated current more than 5 sec. without proper heat sink.

Characteristics for Z-Power LED

2. Warm White (NZ10150)

2-1 Electro-Optical characteristics at $I_F=400\text{mA}$, $T_A=25^\circ\text{C}$

Parameter	Symbol	Value			Unit
		Min	Typ	Max	
Luminous Flux ^[1]	Φ_V ^[2]	-	76	-	lm
Correlated Color Temperature ^[3]	CCT	-	3000	-	K
CRI	R_a	-	80	-	-
Forward Voltage ^[4]	V_F	-	3.6	4.25	V
View Angle	$2\theta \frac{1}{2}$	120			deg.
Thermal resistance ^[5]	$R\theta_{J-B}$	16.5			$^\circ\text{C} / \text{W}$
Thermal resistance ^[6]	$R\theta_{J-C}$	11.0			$^\circ\text{C} / \text{W}$

2-2 Absolute Maximum Ratings

Parameter	Symbol	Value	Unit
Forward Current	I_F	450	mA
Power Dissipation	P_d	1.67	W
Junction Temperature	T_j	125	$^\circ\text{C}$
Operating Temperature	T_{opr}	-40 ~ +85	$^\circ\text{C}$
Storage Temperature	T_{stg}	-40 ~ +100	$^\circ\text{C}$
ESD Sensitivity ^[7]	-	$\pm 10,000\text{V}$ HBM	-

*Notes :

[1] SSC maintains a tolerance of $\pm 10\%$ on flux and power measurements.

[2] Φ_V is the total luminous flux output as measured with an integrated sphere.

[3] Correlated Color Temperature is derived from the CIE 1931 Chromaticity diagram.

CCT $\pm 5\%$ tester tolerance

[4] A tolerance of $\pm 0.06\text{V}$ on forward voltage measurements

[5], [6] $R\theta_{J-B}$ is measured with a SSC metal core pcb. ($25^\circ\text{C} \leq T_j \leq 110^\circ\text{C}$)

$R\theta_{J-C}$ is measured with only emitter. ($25^\circ\text{C} \leq T_j \leq 110^\circ\text{C}$)

Break voltage of Metal PCB is 6.5kVAC

[7] It is included the zener chip to protect the product from ESD.

-----Caution-----

1. Please do not drive at rated current more than 5 sec. without proper heat sink

Color Spectrum, $T_A=25^{\circ}\text{C}$

1. Pure White

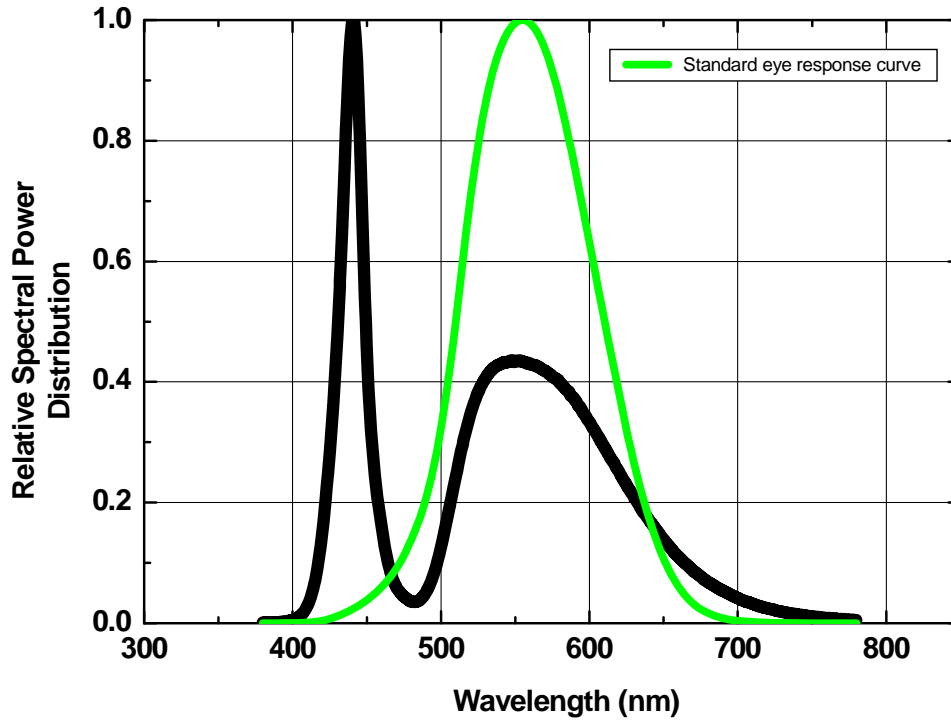

2. Warm White

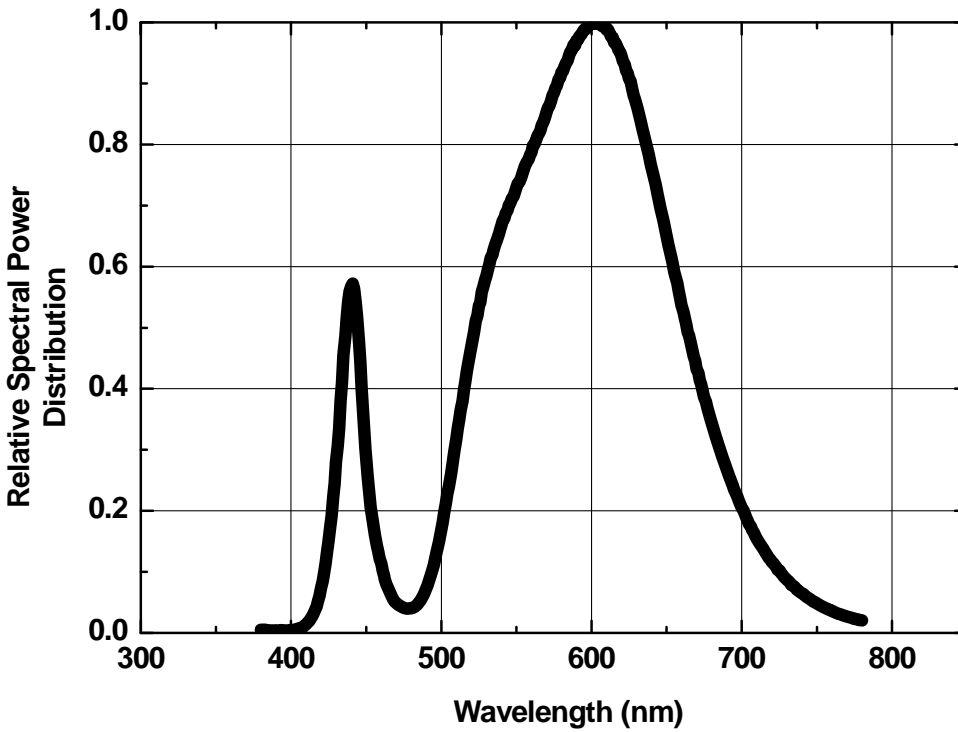

Junction Temperature Characteristics

1. Relative Light Output vs. Junction Temperature at $I_F=400\text{mA}$

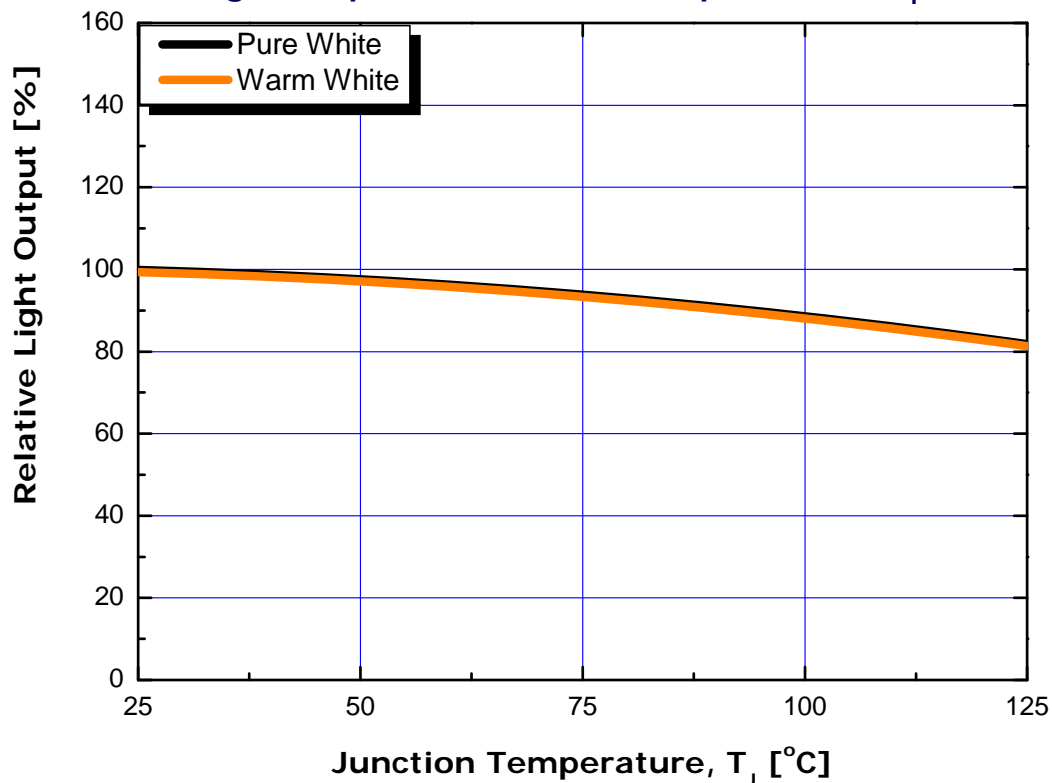

2. Forward Voltage Shift vs. Junction Temperature at $I_F=400\text{mA}$

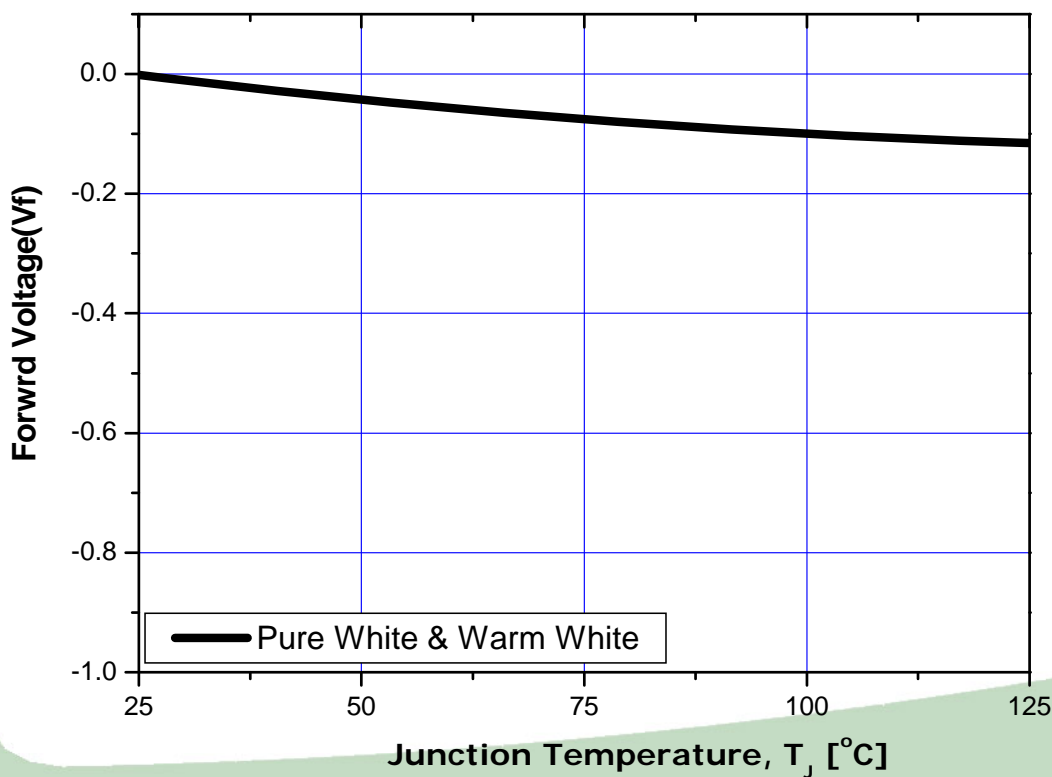

Optical characteristics

1. Forward Voltage vs. Forward Current, $T_A=25^\circ\text{C}$

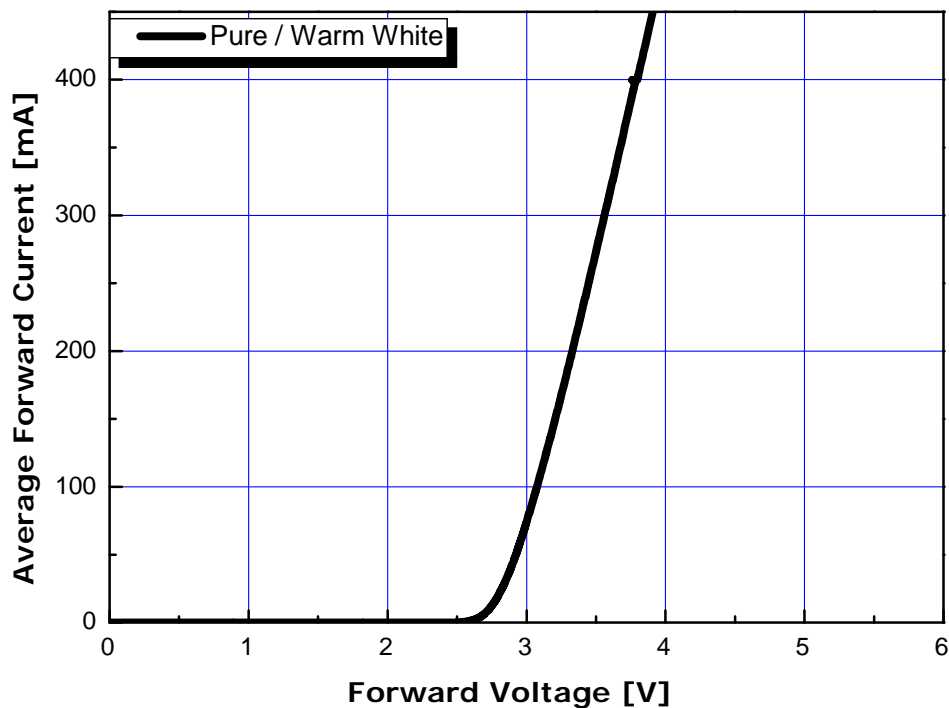

2. Forward Current vs. Normalized Relative Luminous Flux $T_A=25^\circ\text{C}$

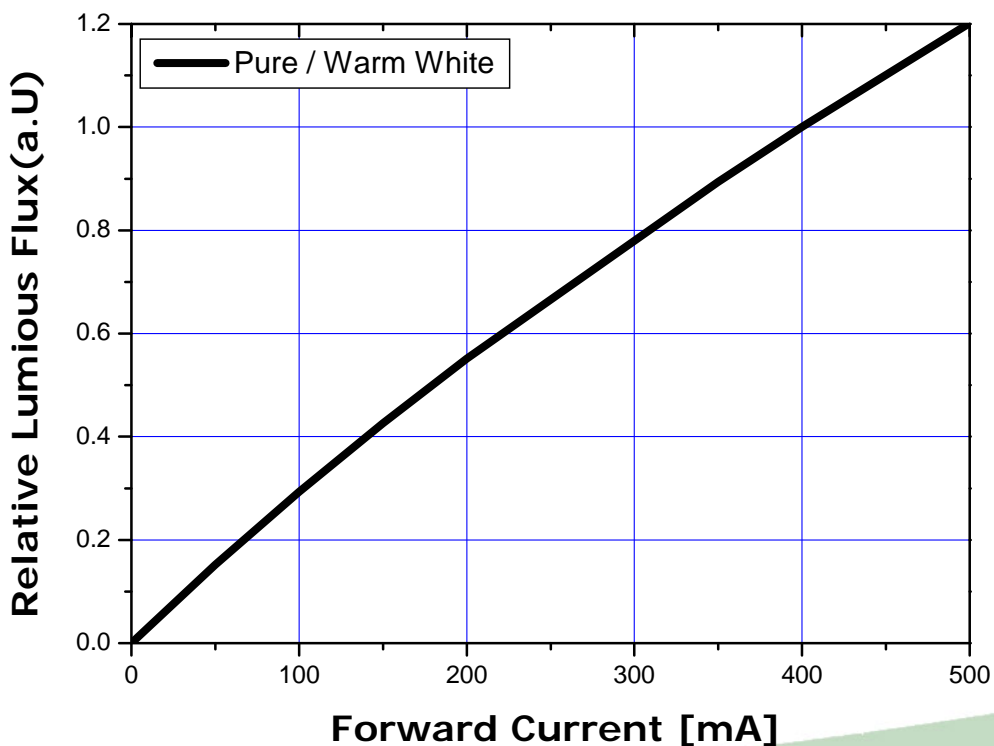

Ambient Temperature vs Allowable Forward Current

1. Pure White, Warm white ($T_{JMAX} = 125\text{ }^{\circ}\text{C}$, 400mA)

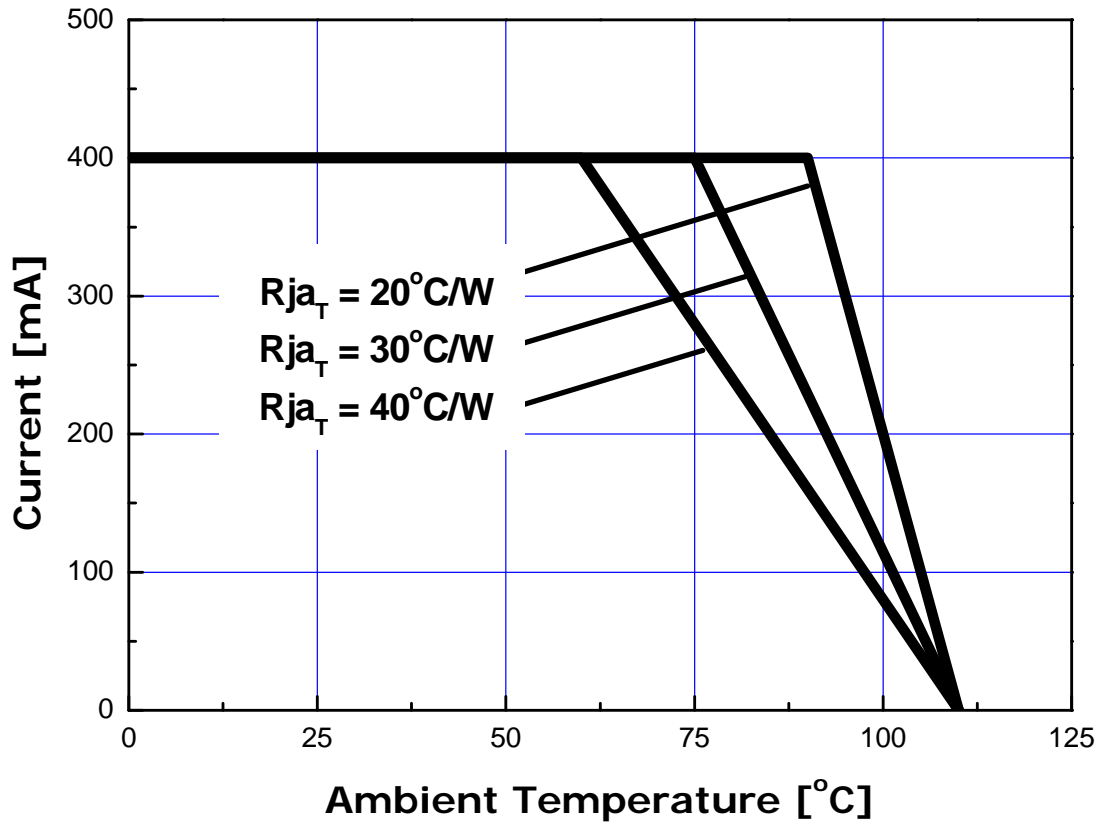

Typical Flat Type Radiation pattern

1. Pure White, Warm white

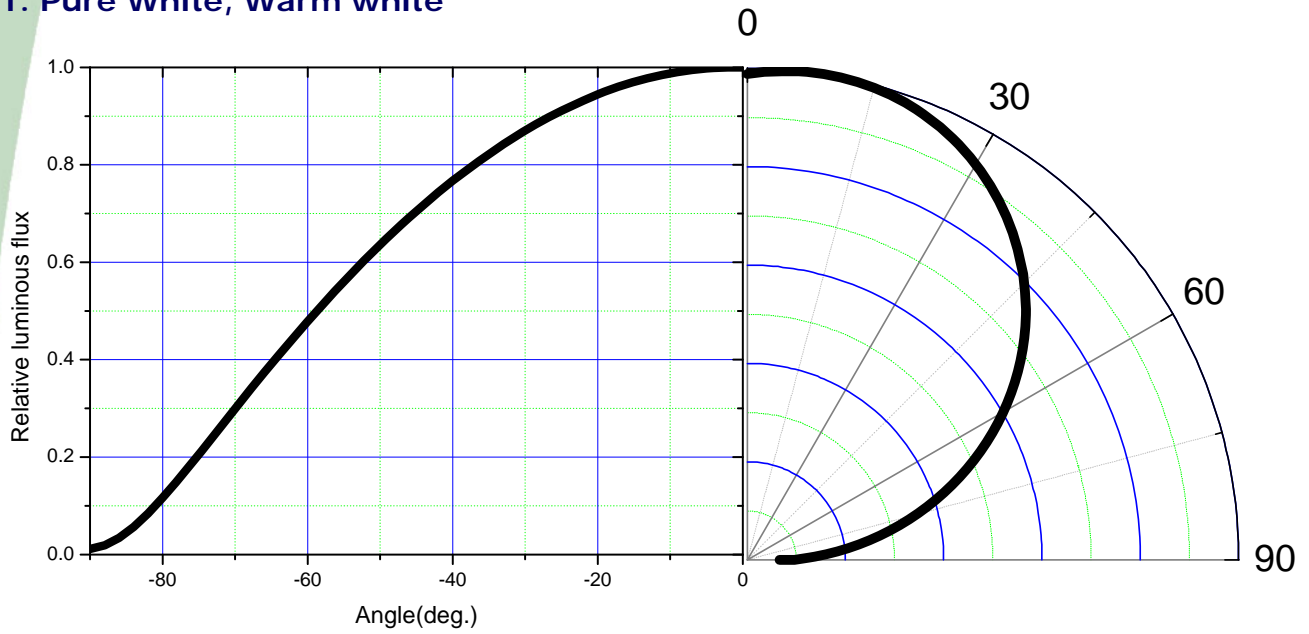

Packing

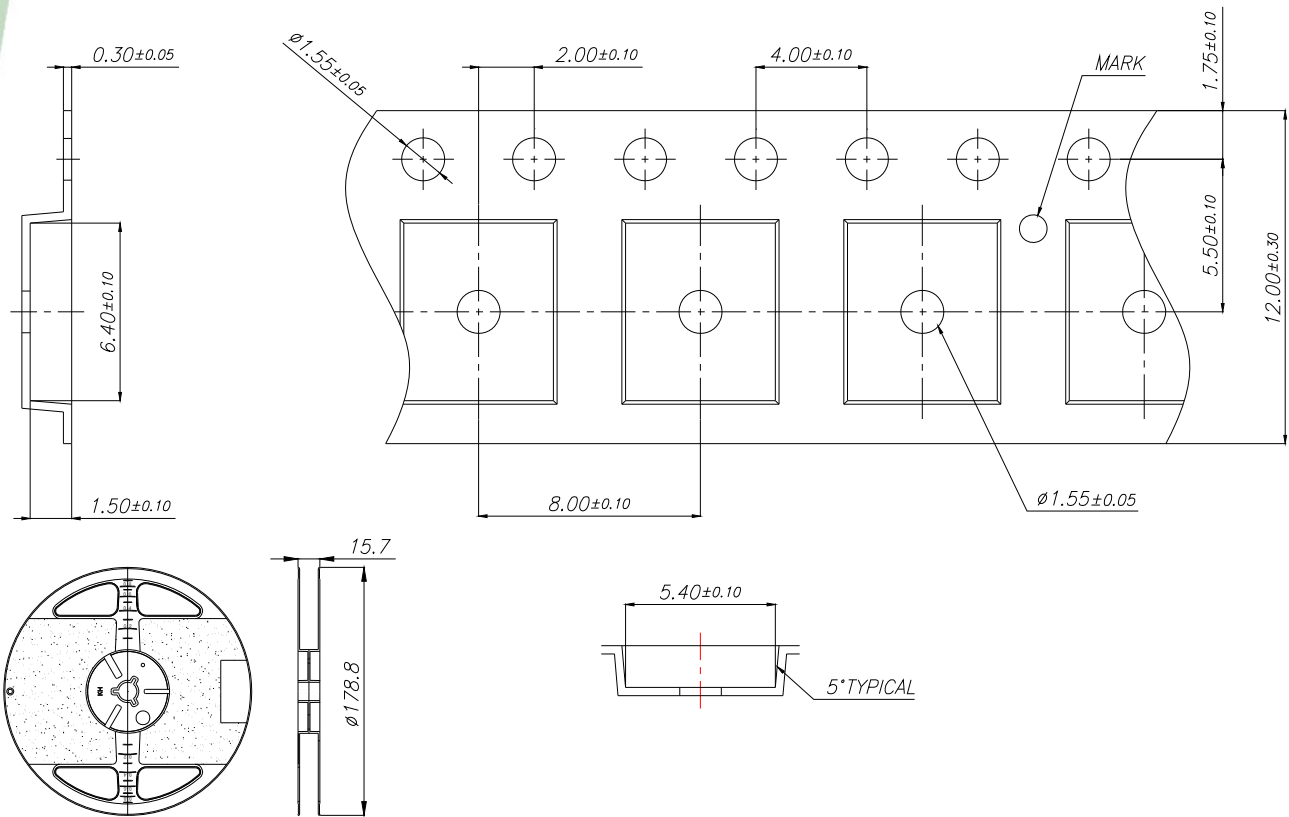

Note:

- 1)Quantity : 500 or 1000pcs/Reel
- 2)Cumulative Tolerance : Cumulative Tolerance/10 pitches to be $\pm 0.2\text{mm}$
- 3)Adhesion Strength of Cover Tape : Adhesion strength to be 0.1-0.7N when the cover tape is turned off from the carrier tape at the angle of 10 to the carrier tape
- 4)Package : P/N, Manufacturing data Code No. and quantity to be indicated on a damp proof Package
- 5) The appearance and specifications of the product may be changed for improvement without notice.

● Reel Packing Structure

Reel

RANK: XXXX
 QUANTITY : XXXX
 LOT NUMBER : XXXXXXXXXXXX
 PART NUMBER : XXXXXXXX
 SEOUL SEMICONDUCTOR CO., LTD.

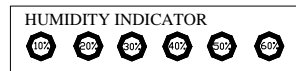
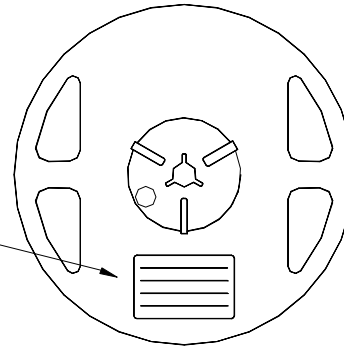

Aluminum Vinyl Bag

RANK: XXXX
 QUANTITY : XXXX
 LOT NUMBER : XXXXXXXXXXXX
 PART NUMBER : XXXXXXXX
 SEOUL SEMICONDUCTOR CO., LTD.

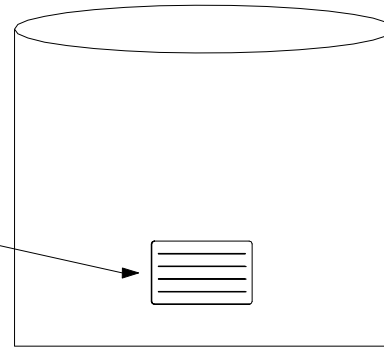

Outer Box Structure

Material : Paper(SW3B(B))

TYPE	SIZE (mm)		
	Ⓐ	Ⓑ	Ⓒ
7inch	245	220	102
	245	220	142

① SIDE

RANK: XXXX
 QUANTITY : XXXX
 LOT NUMBER : XXXXXXXXXXXX
 PART NUMBER : XXXXXXXX
 SEOUL SEMICONDUCTOR CO., LTD.

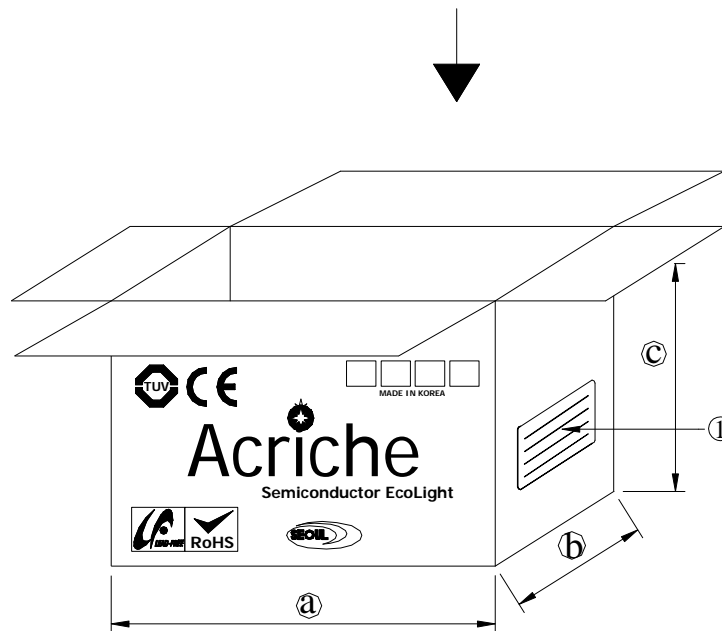

Soldering

1. Reflow Soldering Conditions / Profile

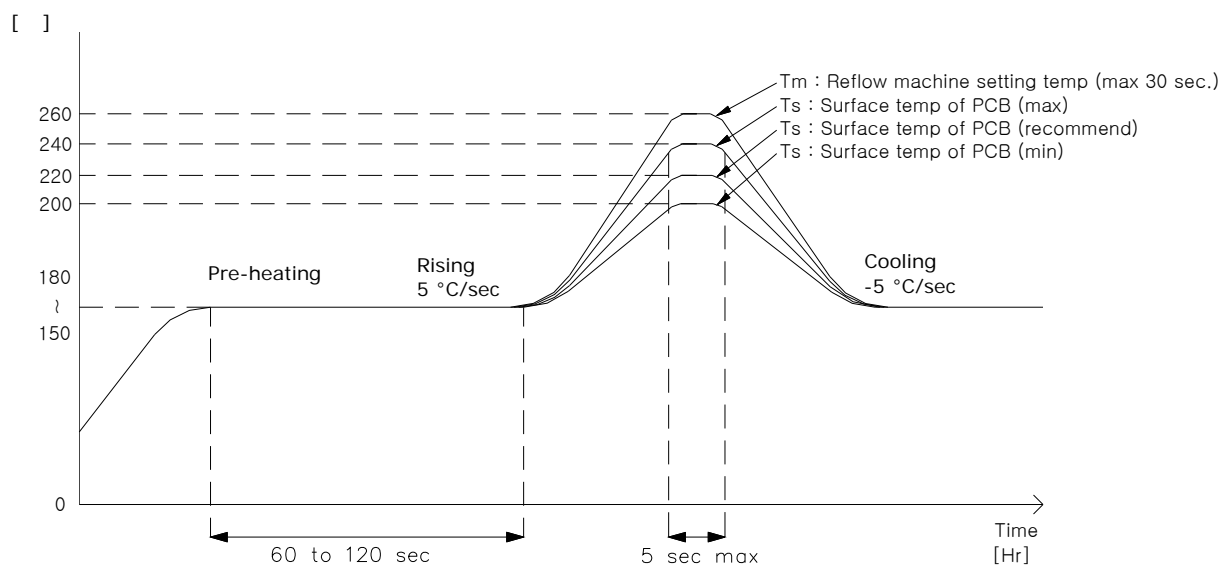

2. Hand Soldering conditions

Lead : Not more than 3 seconds @MAX280°C
 Slug : Use a thermal-adhesives

* Caution

1. Reflow soldering should not be done more than one time.
2. Repairing should not be done after the LEDs have been soldered. When repairing is unavoidable, suitable tools have to be used.
3. Die slug is to be soldered.
4. When soldering, do not put stress on the LEDs during heating.
5. After soldering, do not warp the circuit board.
6. Recommend to use a convection type reflow machine with 7 ~ 8 zones.

Precaution for use

- Storage

To avoid the moisture penetration, we recommend storing Z Power LEDs in a dry box (or desiccator) with a desiccant . The recommended storage conditions are Temperature 5 to 30 degrees Centigrade. Humidity 50% maximum.
- Precaution after opening packaging

However LED is correspond SMD, when LED be soldered dip, interfacial separation may affect the light transmission efficiency, causing the light intensity to drop.

Attention in followed.

 - a. Soldering should be done right after opening the package(within 24Hrs).
 - b. Keeping of a fraction
 - Sealing
 - Temperature : 5 ~ 40℃ Humidity : less than 30%
 - c. If the package has been opened more than 1week or the color of desiccant changes, components should be dried for 10-12hr at 60±5℃
- Any mechanical force or any excess vibration shall not be accepted to apply during cooling process to normal temp. after soldering.
- Please avoid rapid cooling after soldering.
- Components should not be mounted on warped direction of PCB.
- Anti radioactive ray design is not considered for the products listed here in.
- Gallium arsenide is used in some of the products listed in this publication. These products are dangerous if they are burned or shredded in the process of disposal. It is also dangerous to drink the liquid or inhale the gas generated by such products when chemically disposed.
- This device should not be used in any type of fluid such as water, oil, organic solvent and etc. When washing is required, IPA(Isopropyl Alcohol) should be used.
- When the LEDs are illuminating, operating current should be decided after considering the package maximum temperature.
- LEDs must be stored to maintain a clean atmosphere. If the LEDs are stored for 3 months or more after being shipped from SSC, a sealed container with a nitrogen atmosphere should be used for storage.
- The appearance and specifications of the product may be modified for improvement without notice.
- Long time exposure of sunlight or occasional UV exposure will cause lens discoloration.
- Attaching LEDs, don't use adhesives to generate organic vapor.

Handling of Silicone Resin LEDs

(1) During processing, mechanical stress on the surface should be minimized as much as possible. Sharp objects of all types should not be used to pierce the sealing compound.



(2) In general, LEDs should only be handled from the side. By the way, this also applies to LEDs without a silicone sealant, since the surface can also become scratched.



(3) When populating boards in SMT production, there are basically no restrictions regarding the form of the pick and place nozzle, except that mechanical pressure on the surface of the resin must be prevented.

This is assured by choosing a pick and place nozzle which is larger than the LED's reflector area.

(4) Silicone differs from materials conventionally used for the manufacturing of LEDs. These conditions must be considered during the handling of such devices. Compared to standard encapsulants, silicone is generally softer, and the surface is more likely to attract dust.

As mentioned previously, the increased sensitivity to dust requires special care during processing. In cases where a minimal level of dirt and dust particles cannot be guaranteed, a suitable cleaning solution must be applied to the surface after the soldering of components.

(5) SSC suggests using isopropyl alcohol for cleaning. In case other solvents are used, it must be assured that these solvents do not dissolve the package or resin.

Ultrasonic cleaning is not recommended. Ultrasonic cleaning may cause damage to the LED.

Rev. 10
October. 2010

www.acriche.com

Document No. : SSC-QP-7-07-24 (Rev.00)