

# Ultraviolet (UV) Metal Can LED

## OUE8A Series



### Features:

- Peak Wavelengths from 380 nm to 420 nm
- Uniform Optical Light Pattern
- High Pulse Current
- Hermetic TO-46 Metal Can Package
- RoHs Compliant—No Mercury
- ESD Protected

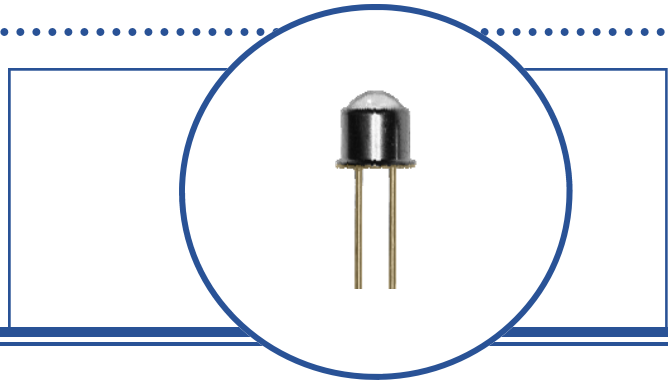

The **OUE8A Series** offers an energy-efficient hermetic TO-46 metal can packaged UV LED source providing a uniform optical light pattern, high current pulse capability, ESD protection and a long operating lifespan. Devices have a 18° typical emission angle with peak wavelengths from 375 nm to 420 nm. In order to meet critical wavelength requirements of the industry, the **OUE8A Series** is divided into groups each with a total wavelength range of only 5 nm. Each wavelength range is subdivided into optical power output ranges from a minimum of 1.8 mW to over 17.0 mW based on power out specifications listed below.

### Applications:

- Adhesive-Ink Photo Catalyst Curing
- Currency / Passport Validation
- Spectroscopy
- Forensic
- Medical

Part Number	Emission Angle	Peak Wavelength (nm)	Optical Power Output (mW)	
		I <sub>F</sub> = 100 mA	I <sub>F</sub> = 100 mA	
		Range	Minimum	Maximum
OUE8A380Y1	18	375 to 380	1.8	8.1
OUE8A385Y1		380 to 385	1.8	8.1
OUE8A390Y1		385 to 390	1.8	8.1
OUE8A395Y1		390 to 395	3.1	9.8
OUE8A400Y1		395 to 400	5.8	13.4
OUE8A405Y1		400 to 405	5.8	13.4
OUE8A410Y1		405 to 410	5.8	13.4
OUE8A415Y1		410 to 415	7.3	15.4
OUE8A420Y1		415 to 420	7.3	15.4

### Part Number Guide

**OUE8 A XXX Y 1**

Optek UV TO-46 LED Series

Sequence Numbers (A→Z)

Power Output (mW) - A through J  
Wavelength (nm) Identifier

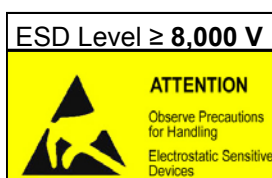

### Warnings and Handling Instructions

UV-LEDs emit invisible ultraviolet radiation when in operation, which may be harmful to eyes or skin, even for brief periods. Do NOT look directly into the UV-LED during operation. Be sure that you and all persons in the vicinity wear adequate "UV" Safety protection for eyes and skin. If you incorporate a UV-LED into a product, be sure to provide appropriate WARNING labels.

RoHs

OPTEK reserves the right to make changes at any time in order to improve design and to supply the best product possible.

# Ultraviolet (UV) Metal Can LED

## OUE8A Series



### Absolute Maximum Ratings ( $T_A=25^{\circ}\text{C}$ unless otherwise noted)

Storage Temperature Range	-40° C to +125° C
Operating Temperature Range	-40° C to +85° C
Allowable Reverse Current ( $I_R$ )	85 mA
Continuous Forward Current	100 mA
Peak Pulsed Forward Current (Pulse Width 100 usec @ 10% duty cycle)	1.6 A
Lead Soldering Temperature [1/16 inch (1.6 mm) from case for 5 seconds with soldering iron]	260° C <sup>(1)</sup>
Power Dissipation	370 mW

Notes:

1. RMA flux is recommended. Duration can be extended to 10 seconds maximum when wave soldering.

### Electrical & Optical Characteristics ( $T_A = 25^{\circ}\text{C}$ unless otherwise noted)

SYMBOL	PARAMETER	MIN	TYP	MAX	UNITS	TEST CONDITIONS
$V_F$	Forward Voltage	3.0	3.3	3.7	V	$I_F = 100 \text{ mA}$
$\Delta V_F / \Delta T$	$V_F$ Temperature Co-efficient		-4.8		mV/°C	
$\Delta \lambda_P$	Spectral Half Width	-	12	-	nm	
$\Delta \lambda_P / \Delta T$	Peak Spectral Shift with Temperature	-	0.035	-	nm/°C	
$\Delta P_O / \Delta T$	Power Output Drop Temperature Co-efficient	-	-0.2	-	%/°C	
$\theta_{HP}$	Emission Angle at Half Power Points	-	18	-	Degree	$I_F = 20 \text{ mA}$

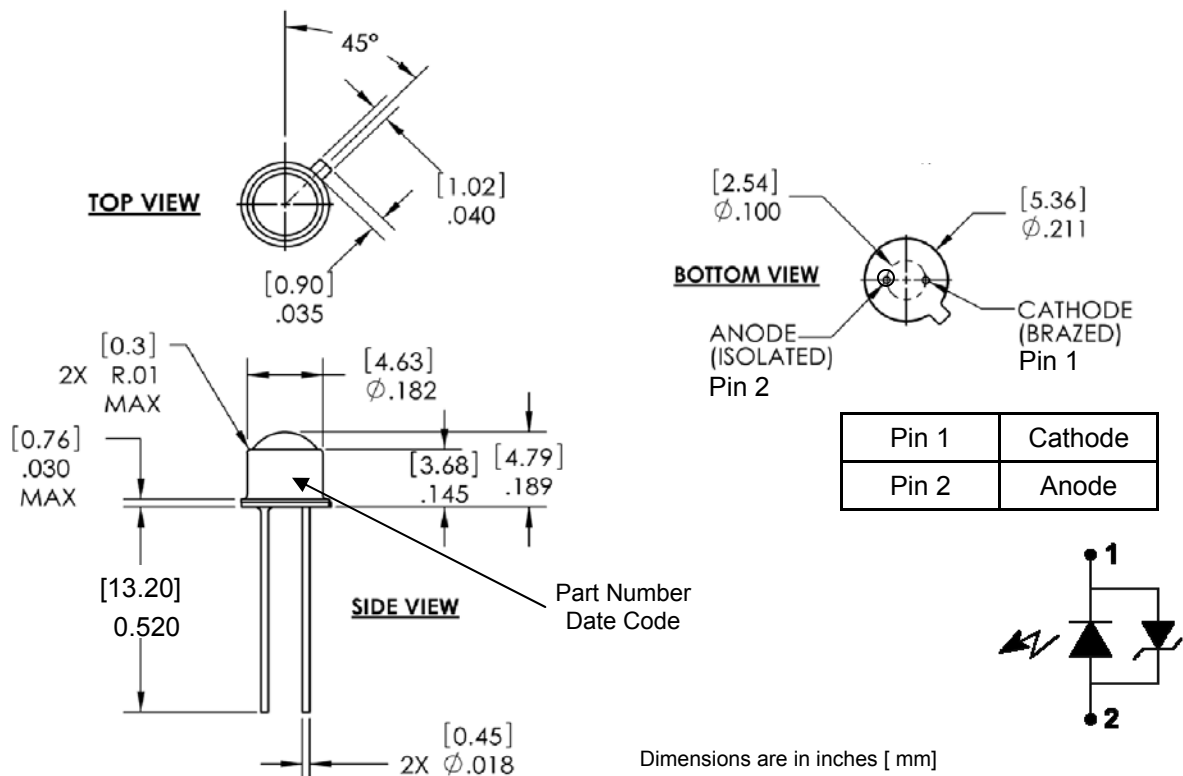

OPTEK reserves the right to make changes at any time in order to improve design and to supply the best product possible.

**Standard Optical Power Bins**

- Devices are sorted to Optical Power Out (mW) as shown below.
- Unless designated, orders may be filled with any or all bins contained.

Power Bin Identification	Optical Power Out (mW) I <sub>F</sub> = 100 mA @ 25°C	
	Bin Minimum	Bin Maximum
OUE8AxxxA	0.5	2.0
OUE8AxxxB	1.8	3.5
OUE8AxxxC	3.1	4.9
OUE8AxxxD	4.5	6.5
OUE8AxxxE	5.8	8.1
OUE8AxxxF	7.3	9.8
OUE8AxxxG	8.8	11.5
OUE8AxxxH	10.4	13.4
OUE8AxxxI	12.1	15.4
OUE8AxxxJ	13.9	17.6

- Where xxx = Part Number Wavelength (nm) on page 1
- Parts for a specific Power Bin are subject to availability.

**Spatial Intensity Distribution**

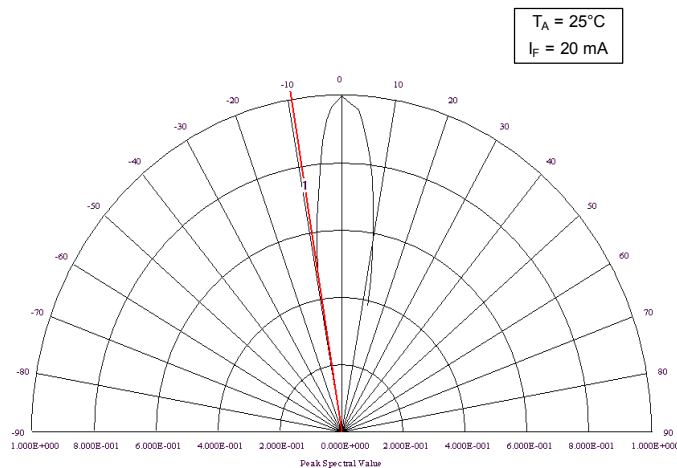

**18 degrees Typical**  
**Normalized Spectral Intensity vs. Angular Displacement**

OPTEK reserves the right to make changes at any time in order to improve design and to supply the best product possible.

Relative Power Output vs Junction Temperature

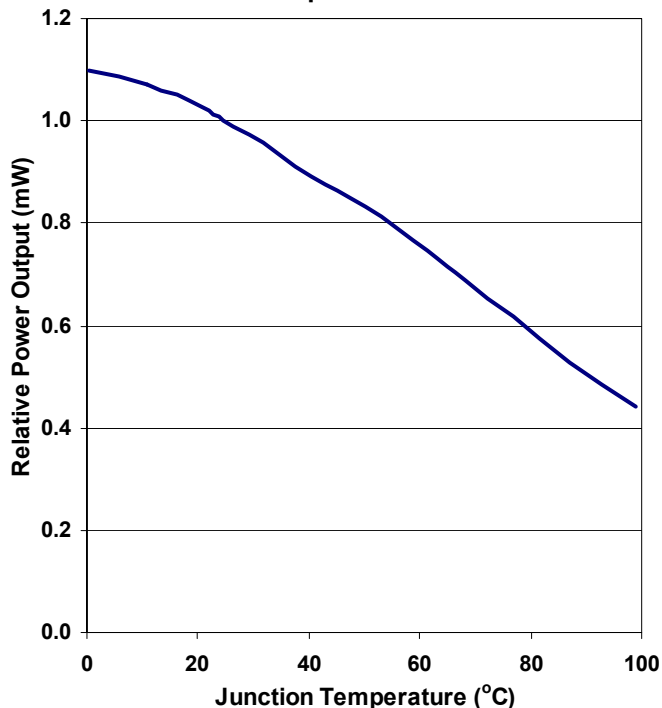

Junction Temperature vs. Maximum Allowable Forward Current

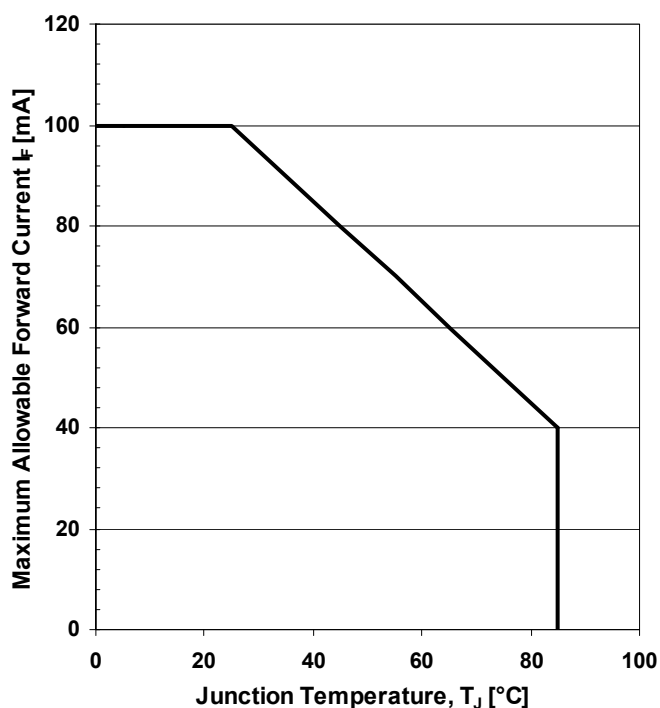

Normalized Peak Spectral Responses

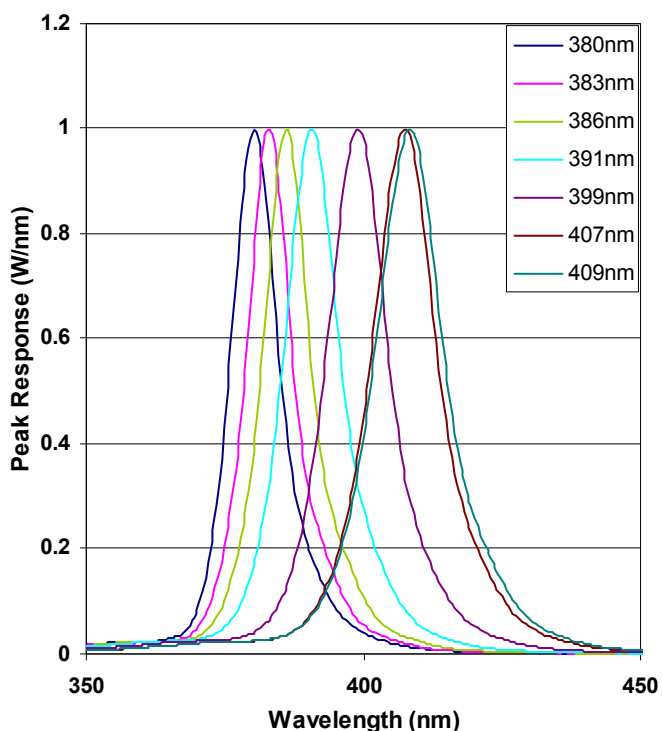

Duty Ratio vs. Allowable Forward Current  
 $T = 1$  ms & variable PW

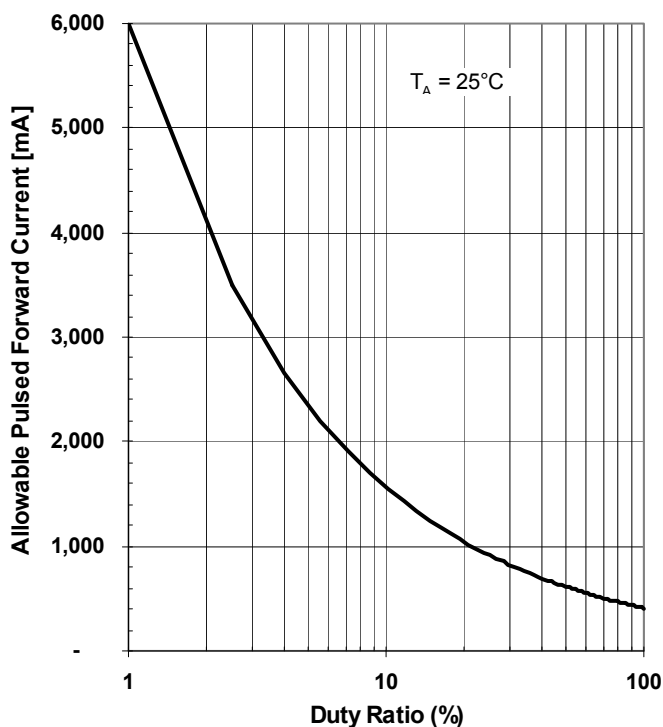

OPTEK reserves the right to make changes at any time in order to improve design and to supply the best product possible.

### Peak Wavelength vs Junction Temperature

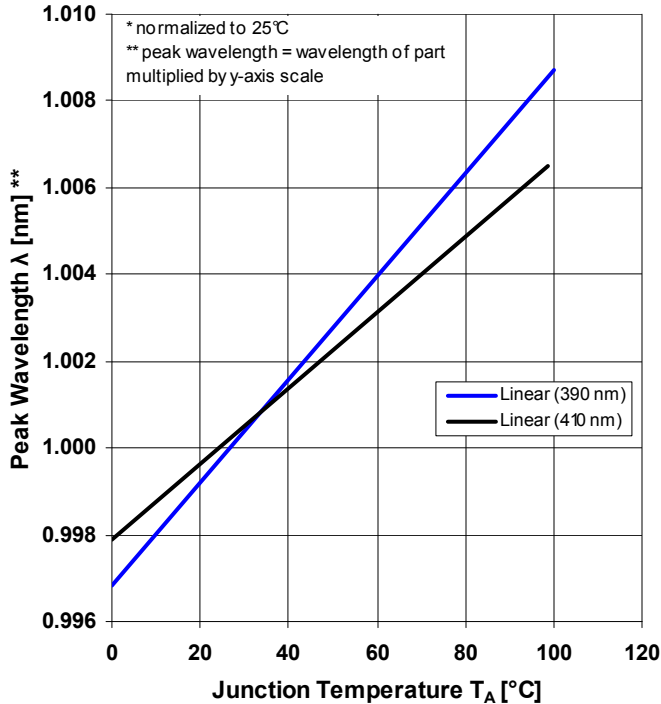

### Forward Voltage vs. Forward Current

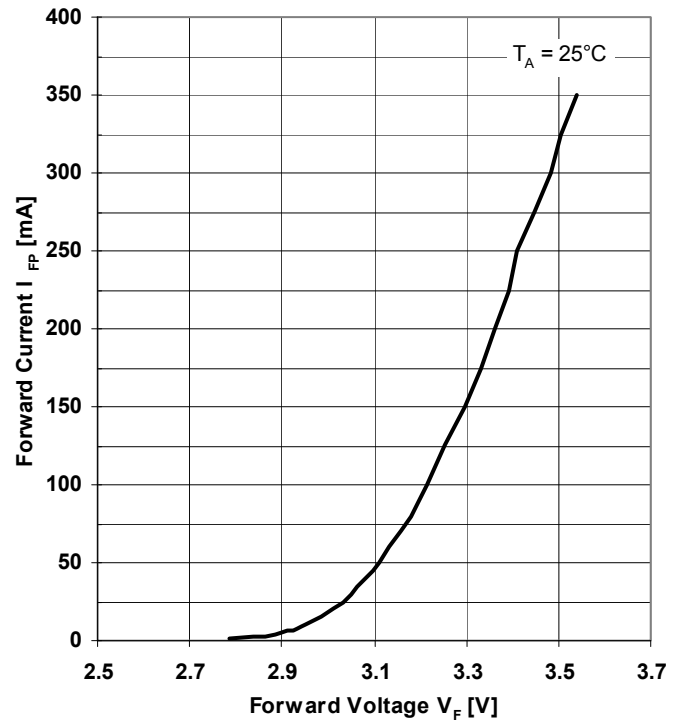

### Typical Power Out vs. Forward Current

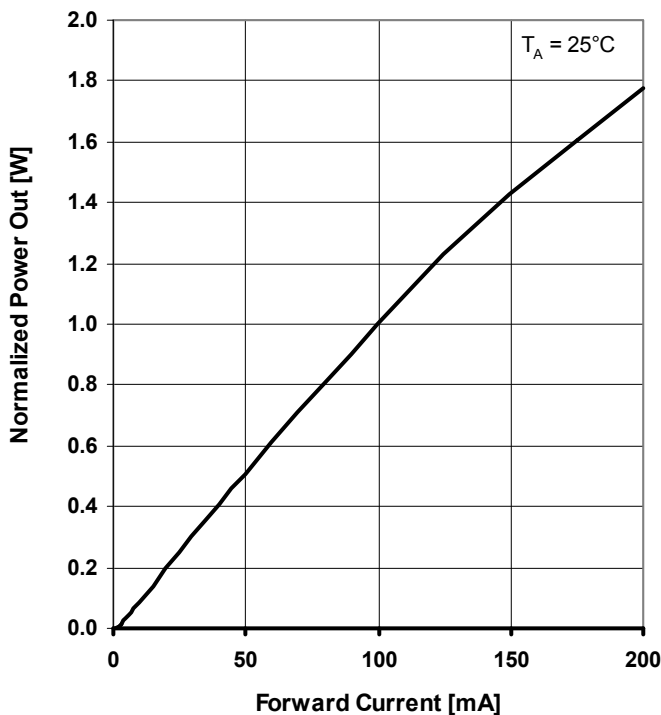

### Typical Peak Wavelength vs. Forward Current

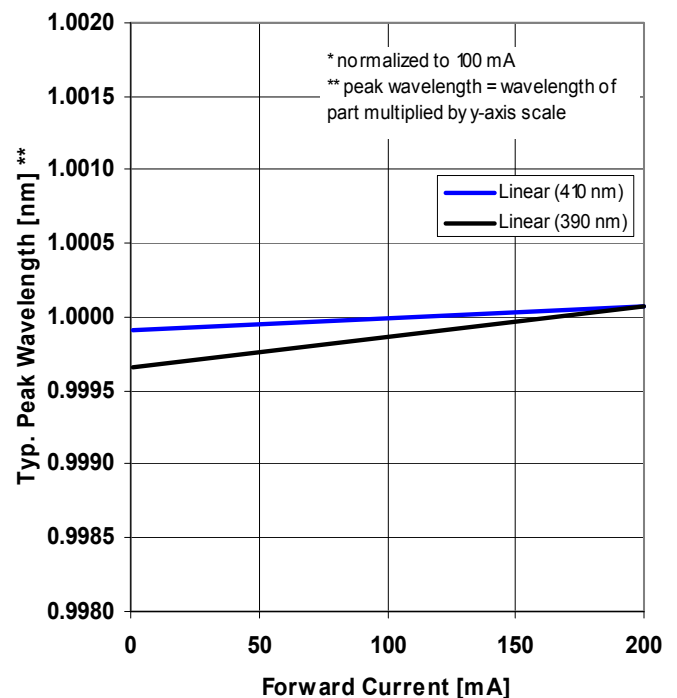

OPTEK reserves the right to make changes at any time in order to improve design and to supply the best product possible.

**Reliability Test**

ITEM	CONDITION	NOTE	FAILURES
Life Test	$T_A = RT, I_F = 20 \text{ mA}$	1000 hrs	0/22
Temperature Humidity Operating	$T_A = RT, I_F = 20 \text{ mA}, RH = 90\%$	1000 hrs	0/22
High Temperature Operating	$T_A = 80^\circ\text{C}, I_F = 5 \text{ mA}$	1000 hrs	0/22
Low Temperature Operating	$T_A = -40^\circ\text{C}, I_F = 20 \text{ mA}$	1000 hrs	0/22
Thermal Shock	$T_A = -40^\circ\text{C}$ (30 min) to $+85^\circ\text{C}$ (30 min) [Transfer Time: 5 sec, 1 cycle = 1hr]	100 cycles	0/22
Resistance to Soldering Heat	$T_s = 260 \pm 5^\circ\text{C}, \text{Time} = 5 \pm 1 \text{ sec}$	1 time	0/11
High Temperature Storage	$T_A = +100^\circ\text{C}$	1000 hrs	0/22
Low Temperature Storage	$T_A = -40^\circ\text{C}$	1000 hrs	0/22

**Criteria for judging damage**

ITEM	SYMBOL	MEASURING CONDITION	CRITERIA FOR JUDGEMENT	
			Minimum	Maximum
Forward Voltage	$V_F$	$I_F = 20 \text{ mA}$	-	USL X 1.1
Optical Power Output	$P_O$	$I_F = 20 \text{ mA}$	LSL X 0.5	-

Notes:

1.  $I_F$  = Forward Current
2. LSL = Lower Specification Limit
3. RH = Relative humidity
4. RT = Room Temperature ~ 25°C
5.  $T_A$  = Ambient Temperature
6.  $T_S$  = Solder Temperature
7. USL = Upper Specification Limit

OPTEK reserves the right to make changes at any time in order to improve design and to supply the best product possible.

**Stress results**

Test	Samples	Test conditions	Total assembly hours	Failures
Operating Life	22	1008 hours, $T_A @ 25^\circ\text{C}$ , 100mW operation, $I_F = 27.7\text{mA}$	22,176	0/22

**D&O 380nm UVLED Build 1 - 100mW burn-in  
Group H  
Tested at  $I_F = 350\text{ mA}$ ,  $T_A = 25^\circ\text{C}$**

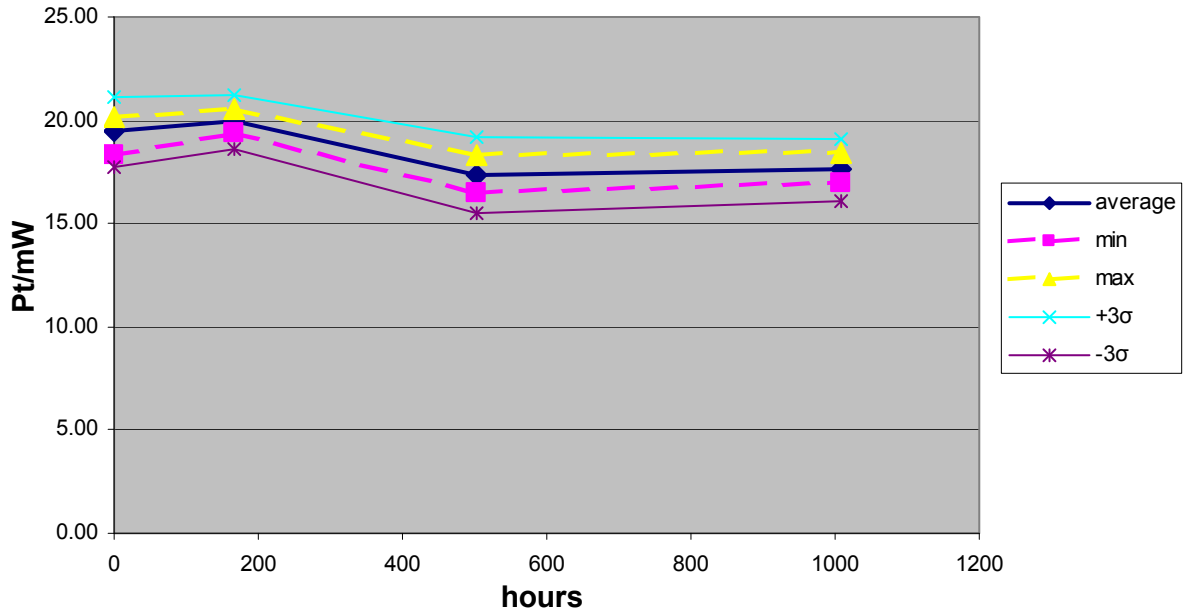

OPTEK reserves the right to make changes at any time in order to improve design and to supply the best product possible.

# Ultraviolet (UV) Metal Can LED

## OUE8A Series



### Shipping Information:

Optek UV LEDs are shipped in either of the below noted conductive trays made for ESD sensitive devices. Each tray contains up to 100 pieces and is then sealed in a plastic ESD bag. Tray dimensions are in inches (mm).

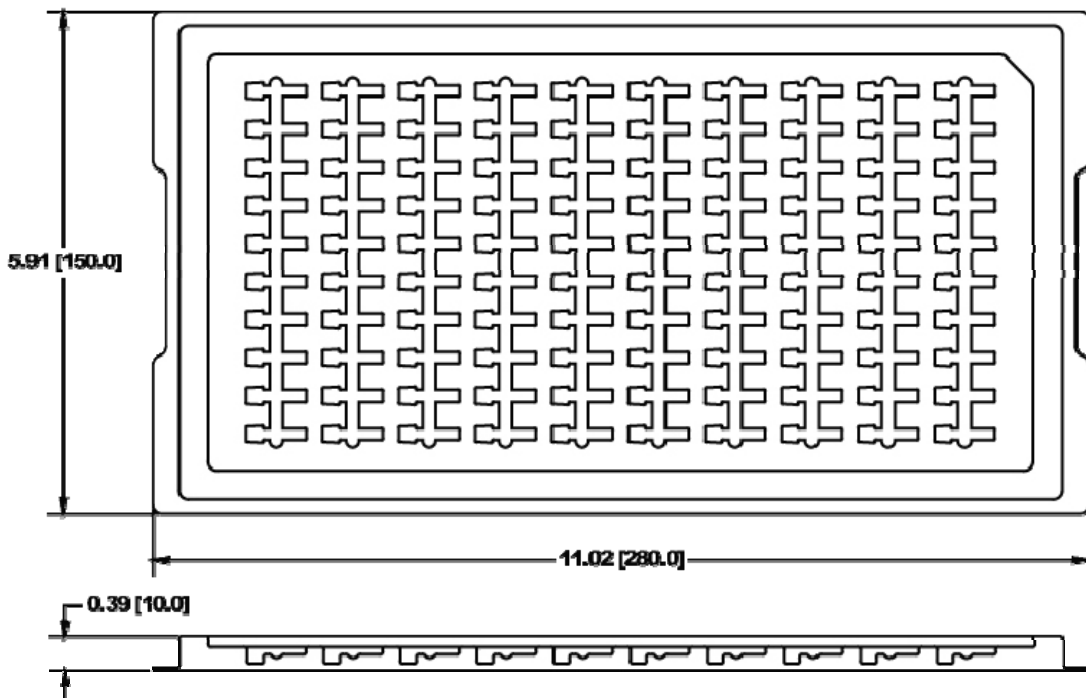
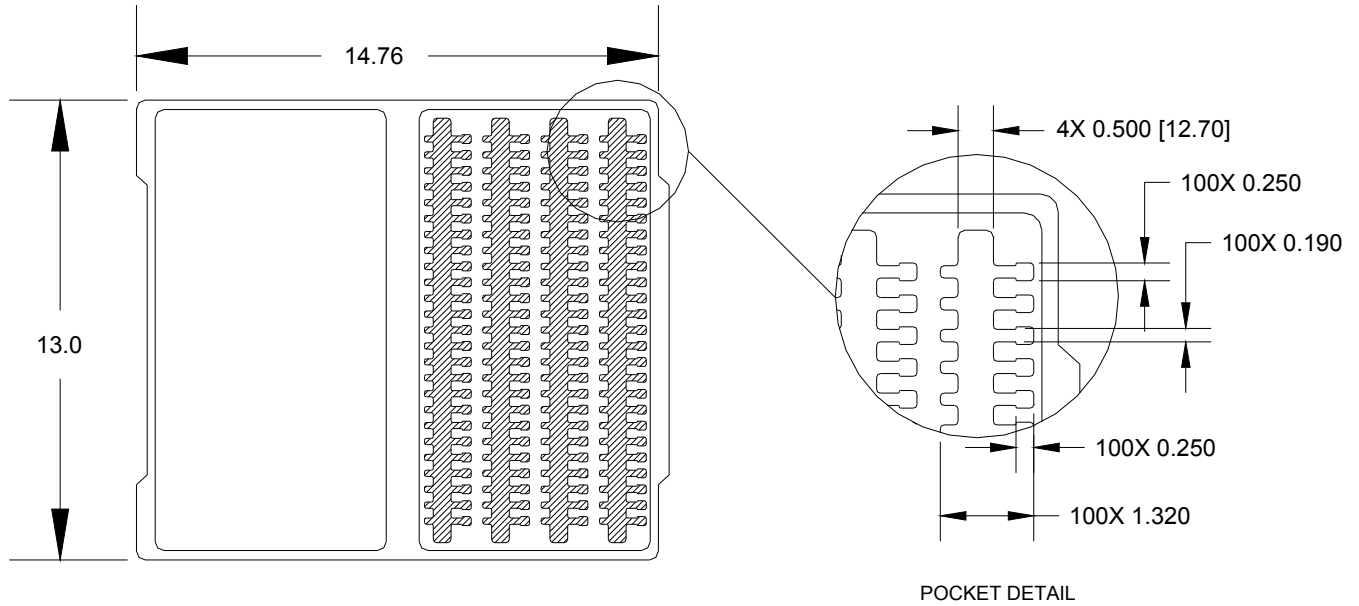

OPTEK reserves the right to make changes at any time in order to improve design and to supply the best product possible.