

Mini half-watt SMD 3.5mm (120° Viewing Angle)

OVS5MxBCR4 Series

- Compact Package Outline of 3.5 x 3.5 x 1.2 mm
- Robust energy-efficient design with long operating life
- Low thermal resistance
- Exceptional spatial uniformity
- Compatible to IR reflow soldering
- High Lumens output

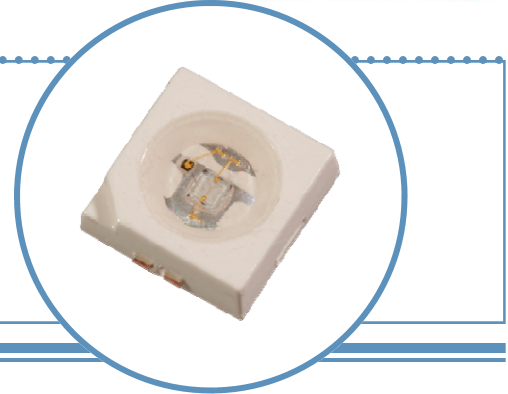

The **mini-half watt** is an energy-efficient packaged LED source that offers high luminance, and a long operating lifespan. This device offers a 120° viewing angle and an ultra-low profile (1.2 mm) making it highly suitable for conventional lighting and specialized applications.

Applications

- Automotive exterior and interior lighting
- Architectural indoor and outdoor lighting
- General lighting
- Display Backlighting

Part Number	Viewing Angle	Emitted Color	Typ. Luminous Flux (lm)	Forward Voltage V_F	Power Dissipation @ 150 mA	Lens Color
OVS5MWBCR4	120	White	25	3.2	0.48 W	Water Clear
OVS5MWWBCR4		Warm White	25	3.2	0.48 W	
OVS5MBBCR4		Blue	6	3.4	0.48 W	
OVS5MGBCR4		Green	25	3.5	0.51 W	

Part Number	Viewing Angle	Emitted Color	Typ. Luminous Intensity (mcd)	Forward Voltage V_F	Power Dissipation @ 150 mA	Lens Color
OVS5MRBCR4	120	Red	4000	2.2	0.33 W	Water Clear
OVS5MABCR4		Amber	4500	2.2	0.33 W	
OVS5MYBCR4		Yellow	5000	2.2	0.33 W	



DO NOT LOOK DIRECTLY AT LED WITH UNSHIELDED EYES OR DAMAGE TO RETINA MAY OCCUR.

OPTEK reserves the right to make changes at any time in order to improve design and to supply the best product possible.

Mini half-watt SMD 3.5mm OVS5MxB CR4

Absolute Maximum Ratings $T_A = 25^\circ\text{C}$

	Red, Amber, Yellow	Green, Blue	White	Warm White
DC Forward Current	200 mA	180 mA		
Peak Pulsed Forward Current ¹	1000 mA	350 mA		
Reverse Voltage	12V @ 10 μ A	Not designed for reverse bias		
Junction Temperature ²	125°C			
Power Dissipation	750mW			
Storage and Operating Temperature	-40° ~ +100 ° C			
ESD Threshold (HBM)	2000V			

Notes:

1. Pulse width $t_p \leq 10\mu\text{s}$, Duty cycle = 0.1
2. Thermal Resistance = 5 C/W

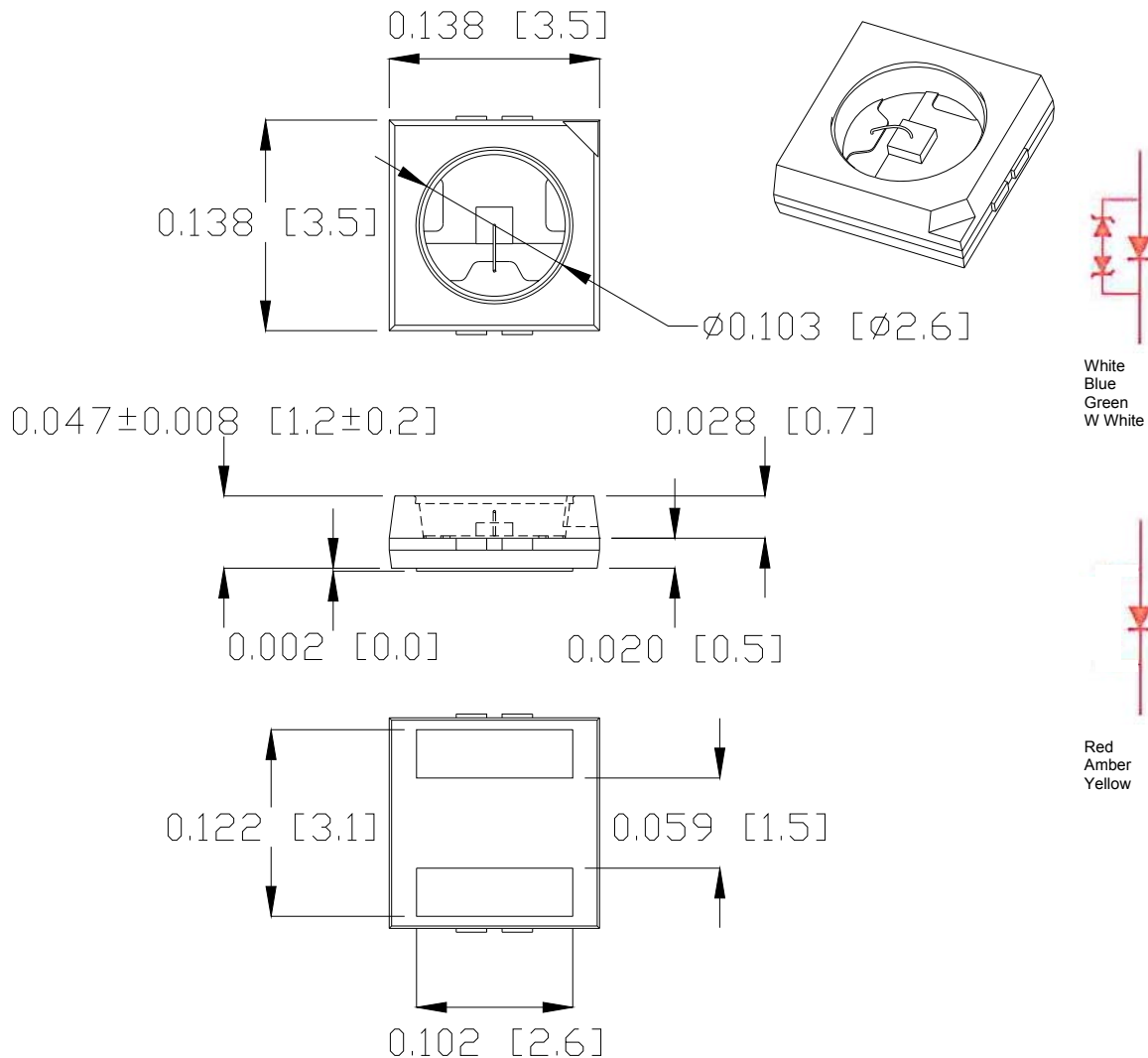

OPTEK reserves the right to make changes at any time in order to improve design and to supply the best product possible.

Optical and Electrical Characteristics - Red, Amber, Yellow ($I_F = 150 \text{ mA}$, $T_A = 25^\circ \text{ C}$)

SYMBOL	PARAMETER	MIN	TYP	MAX	UNITS	
V_F	Forward Voltage	1.8	2.2	2.9	V	
Φ	Luminous Intensity	Red	2850	4000	5600	mcd
		Amber	2850	4500	5600	
		Yellow	3550	5000	7150	
λ_D	Dominant Wavelength	Red	620	625	630	nm
		Amber	610	615	621	
		Yellow	585	590	594	
I_R	Reverse Current @ 12 V	----	10	----	μA	
$2\theta_{1/2}$	50% Power Angle	----	120	----	deg	

Optical and Electrical Characteristics - Blue, Green ($I_F = 150 \text{ mA}$, $T_A = 25^\circ \text{ C}$)

SYMBOL	PARAMETER	MIN	TYP	MAX	UNITS	
V_F	Forward Voltage	3.0	3.4	3.9	V	
Φ	Luminous Flux	Blue	4	6.7	-	lm
		Green	17	25	-	
λ_D	Dominant Wavelength	Blue	464	470	476	nm
		Green	520	527	535	
$2\theta_{1/2}$	50% Power Angle	----	120	----	deg	

Optical and Electrical Characteristics - White, Warm White ($I_F = 150 \text{ mA}$, $T_A = 25^\circ \text{ C}$)

SYMBOL	PARAMETER	MIN	TYP	MAX	UNITS	
V_F	Forward Voltage	3.0	3.6	4.1	V	
Φ	Luminous Flux	White	18.1	-	30.6	lm
		Warm White				
$2\theta_{1/2}$	50% Power Angle	----	120	----	deg	

OPTEK reserves the right to make changes at any time in order to improve design and to supply the best product possible.

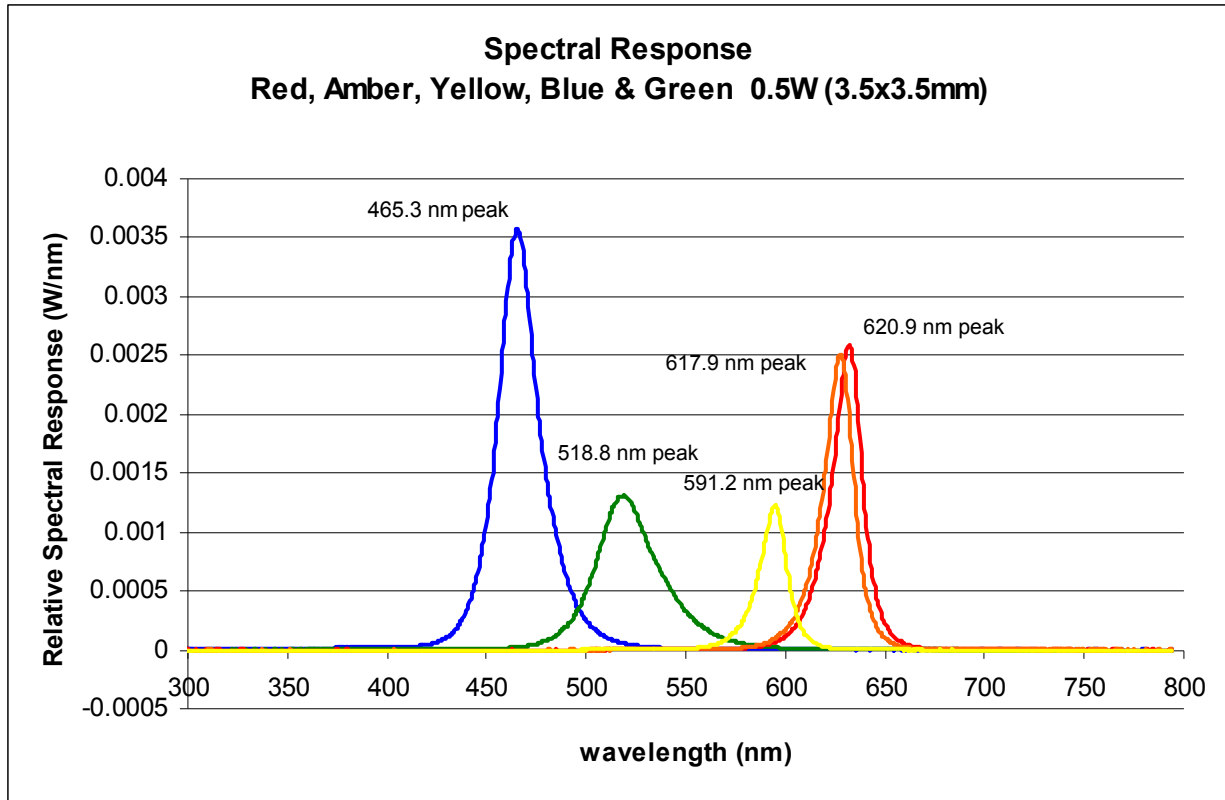

OVS5MBBCR4 (Blue)

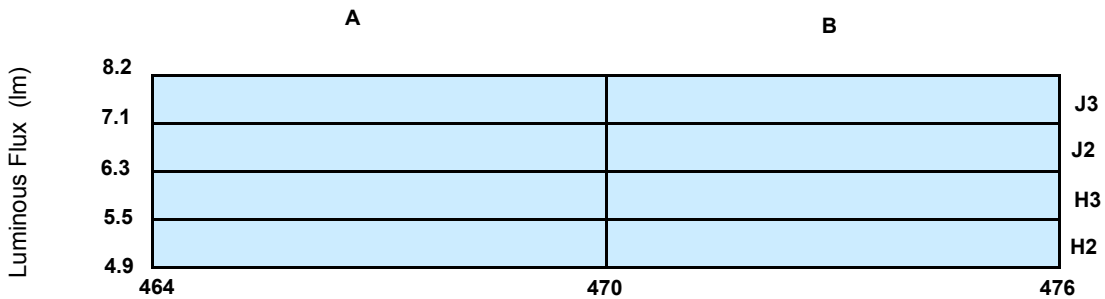

OVS5MGBCR4 (Green)

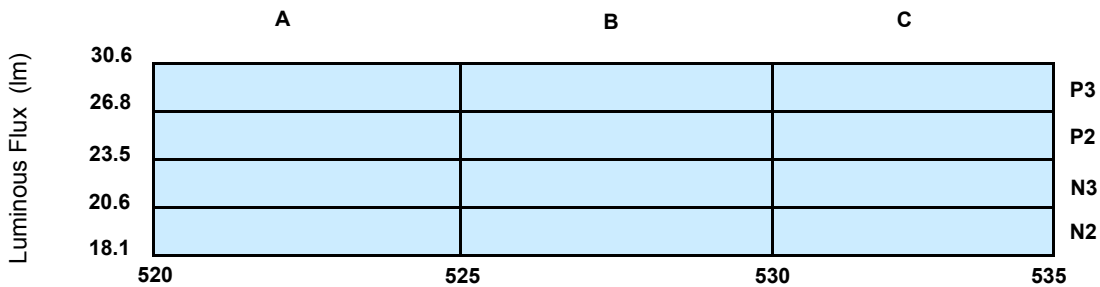

OPTeK reserves the right to make changes at any time in order to improve design and to supply the best product possible.

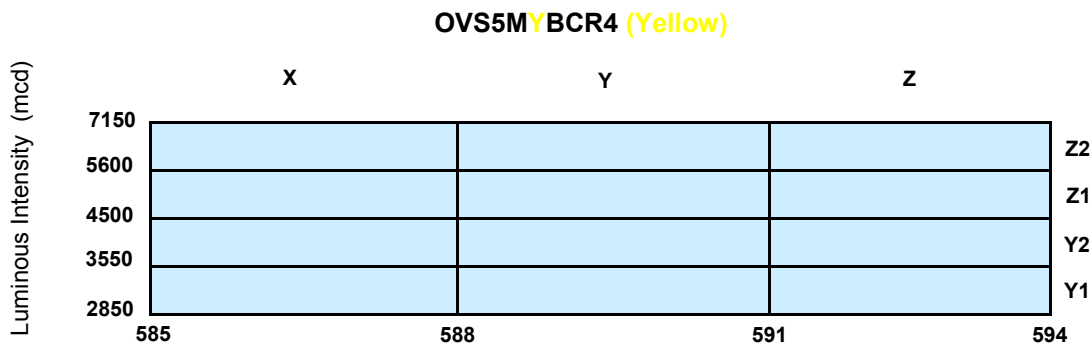
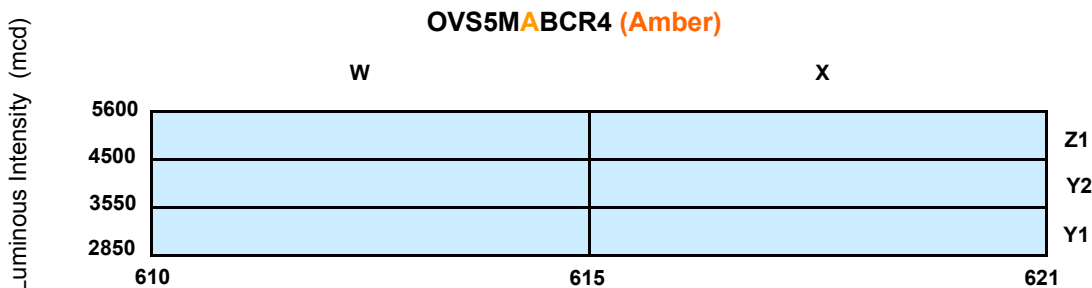
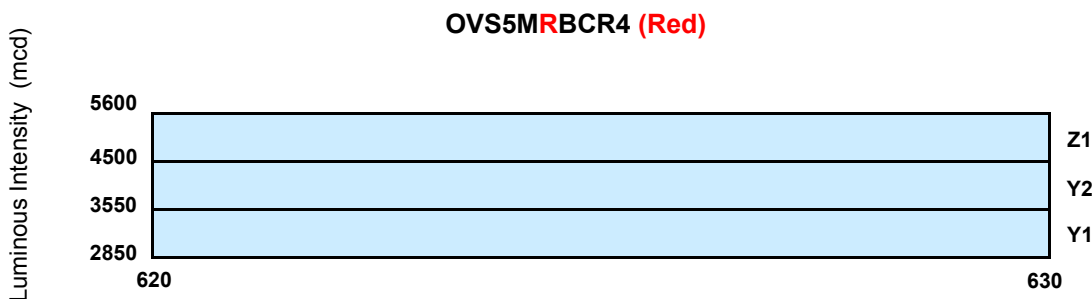

OPTEK reserves the right to make changes at any time in order to improve design and to supply the best product possible.

Mini half-watt SMD 3.5mm OVS5MxBCR4



Standard Bins ($I_F = 150 \text{ mA}$) **OVS5MWBCR4 (White)**

Lamps are sorted to luminous flux (Φ), chromaticity coordinates, and correlated color temperature (CCT) bins shown. Orders may be filled with any or all bins contained as below.

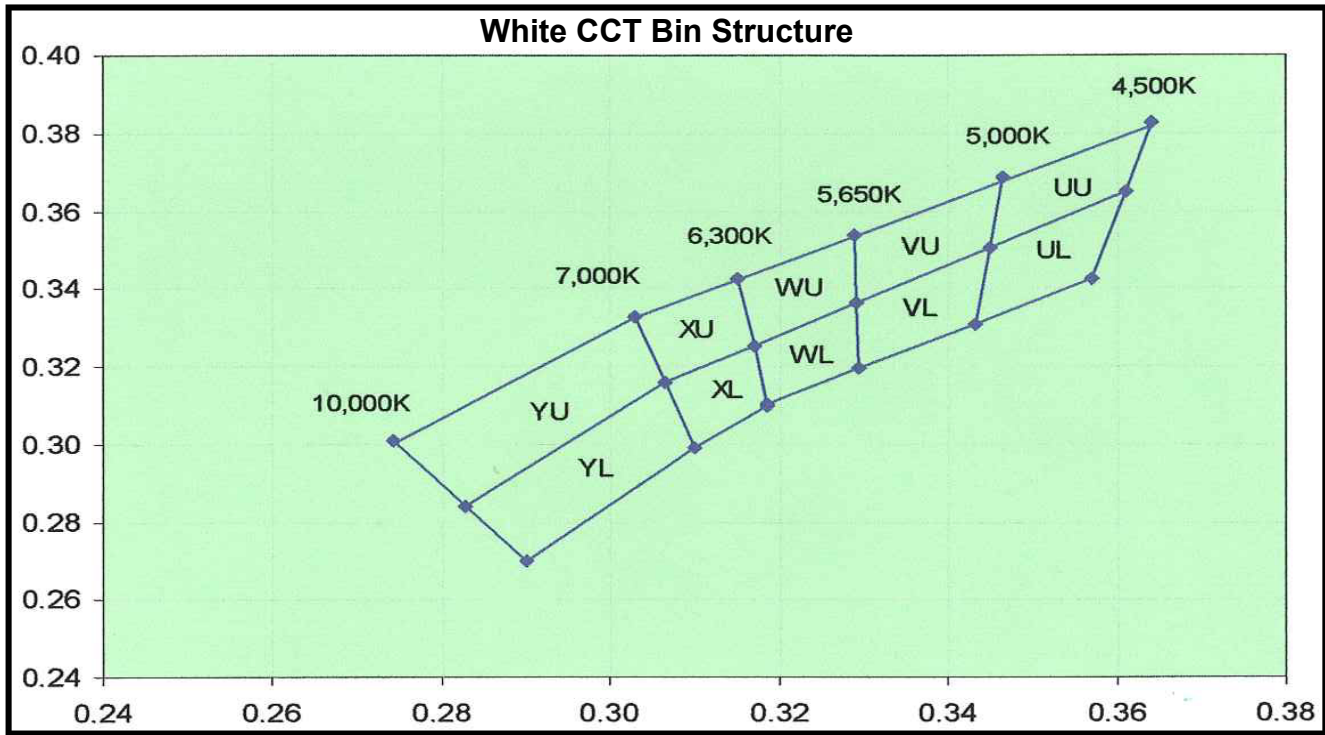

Bin		1	2	3	4
YU	C_x	0.274	0.283	0.307	0.303
	C_y	0.301	0.284	0.316	0.333
YL	C_x	0.283	0.290	0.310	0.307
	C_y	0.284	0.270	0.299	0.316
XU	C_x	0.303	0.307	0.317	0.315
	C_y	0.333	0.316	0.325	0.343
XL	C_x	0.307	0.310	0.319	0.317
	C_y	0.316	0.299	0.310	0.325
WU	C_x	0.315	0.317	0.329	0.329
	C_y	0.343	0.325	0.336	0.354
WL	C_x	0.317	0.319	0.329	0.329
	C_y	0.325	0.310	0.319	0.336
VU	C_x	0.329	0.329	0.345	0.347
	C_y	0.354	0.336	0.350	0.368
VL	C_x	0.329	0.329	0.343	0.345
	C_y	0.336	0.319	0.331	0.350
UU	C_x	0.347	0.345	0.361	0.364
	C_y	0.368	0.350	0.365	0.383
UL	C_x	0.345	0.343	0.357	0.361
	C_y	0.350	0.331	0.343	0.365

Φ	Luminous Flux (lm)	
Bin	Min	Max
N2	18.1	20.6
N3	20.6	23.5
P2	23.5	26.8
P3	26.8	30.6

OPTeK reserves the right to make changes at any time in order to improve design and to supply the best product possible.

Mini half-watt SMD 3.5mm OVS5MxBCR4



Standard Bins ($I_F = 150 \text{ mA}$) OVS5MWWBCR4 (Warm White)

Lamps are sorted to luminous flux (Φ), chromaticity coordinates, and correlated color temperature (CCT) bins shown. Orders may be filled with any or all bins contained as below.

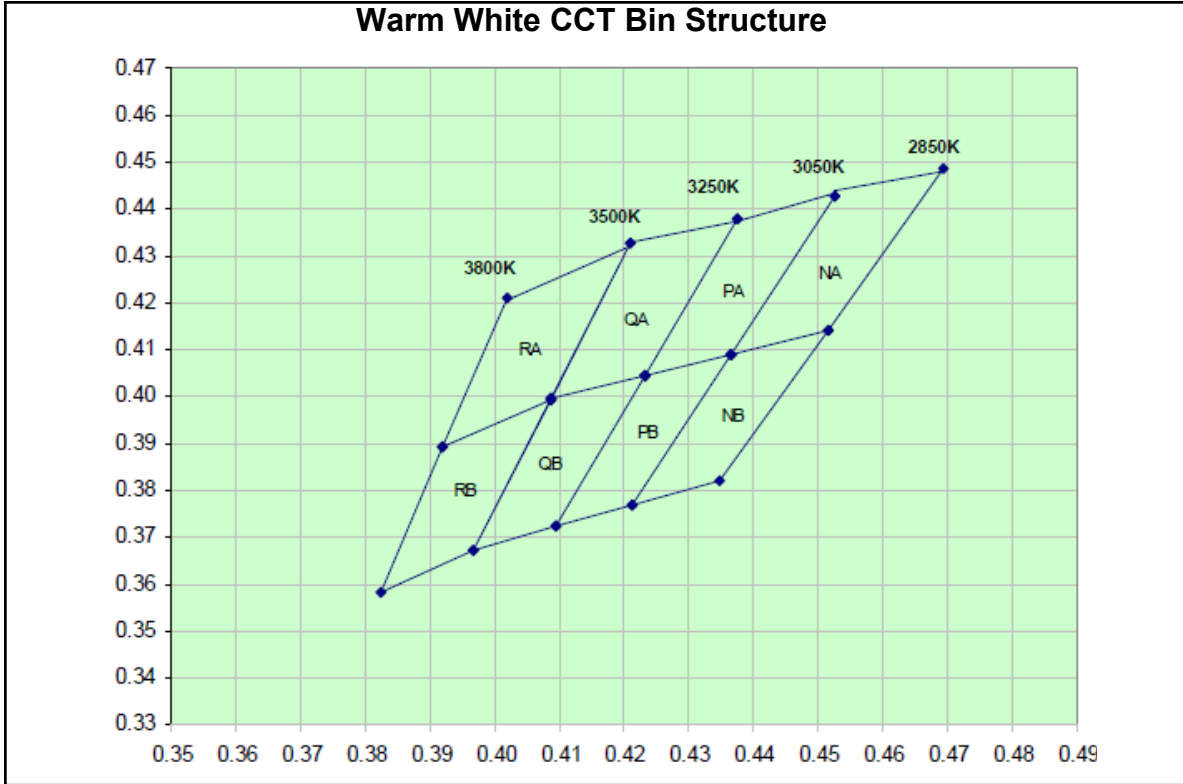

Bin		1	2	3	4
RA	C _X	0.402	0.392	0.409	0.421
	C _Y	0.421	0.389	0.399	0.433
RB	C _X	0.392	0.382	0.397	0.409
	C _Y	0.389	0.358	0.367	0.399
QA	C _X	0.421	0.409	0.423	0.437
	C _Y	0.433	0.400	0.405	0.438
QB	C _X	0.409	0.397	0.409	0.423
	C _Y	0.40	0.367	0.372	0.405
PA	C _X	0.437	0.423	0.436	0.452
	C _Y	0.438	0.405	0.409	0.443
PB	C _X	0.423	0.409	0.421	0.436
	C _Y	0.405	0.372	0.377	0.409
NA	C _X	0.452	0.436	0.451	0.469
	C _Y	0.443	0.409	0.414	0.448
NB	C _X	0.436	0.4521	0.435	0.451
	C _Y	0.409	0.377	0.382	0.414

Bin	Φ Luminous Flux (lm)	
	Min	Max
N2	18.1	20.6
N3	20.6	23.5
P2	23.5	26.8
P3	26.8	30.6

OPTEK reserves the right to make changes at any time in order to improve design and to supply the best product possible.

Relative Intensity vs Forward Current - All

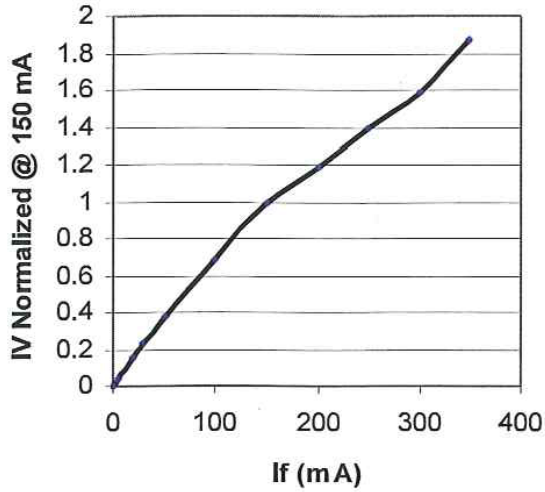

Forward Voltage vs Forward Current - All

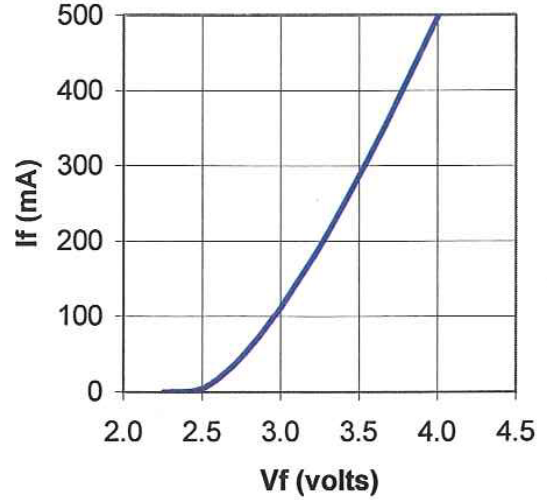

Spectral Response - White

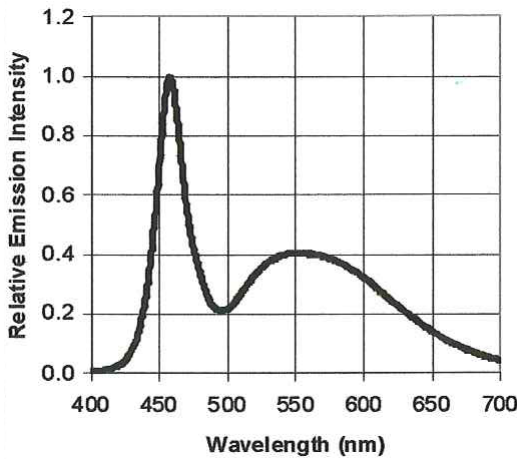

Spectral Response - Warm White

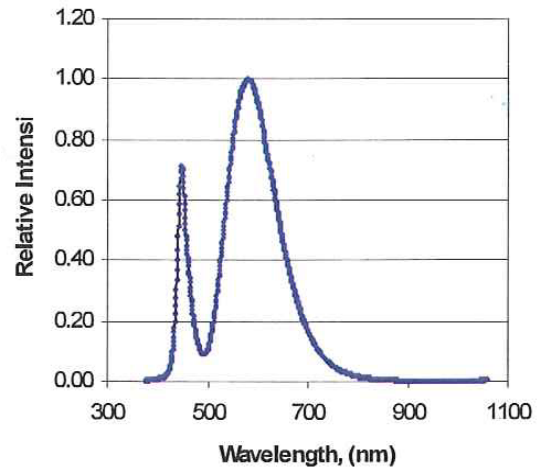

Maximum Current Vs Ambient Temperature—All

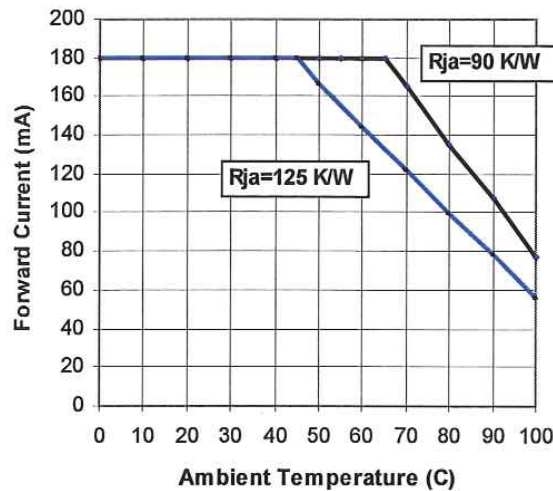

OPTEK reserves the right to make changes at any time in order to improve design and to supply the best product possible.

Mini half-watt SMD 3.5mm OVS5MxBCR4



Reliability Data - 10K Hour Projection
OVS5MWBCR4 White @ 150 mA & 25°C Ambient

Preconditioning Steps	
Preconditioning as per JEDEC Level 2A requirements of JESD22-A113-B	<ul style="list-style-type: none"> Bake @ 125°C for 24 hours Storage @ 60°C / 60% RH for 120 hours 3 x IR Reflow Soldering @ 260°C / 10 second minimum @ max profile temp
IR Reflow Soldering on FR4 PCBoard	

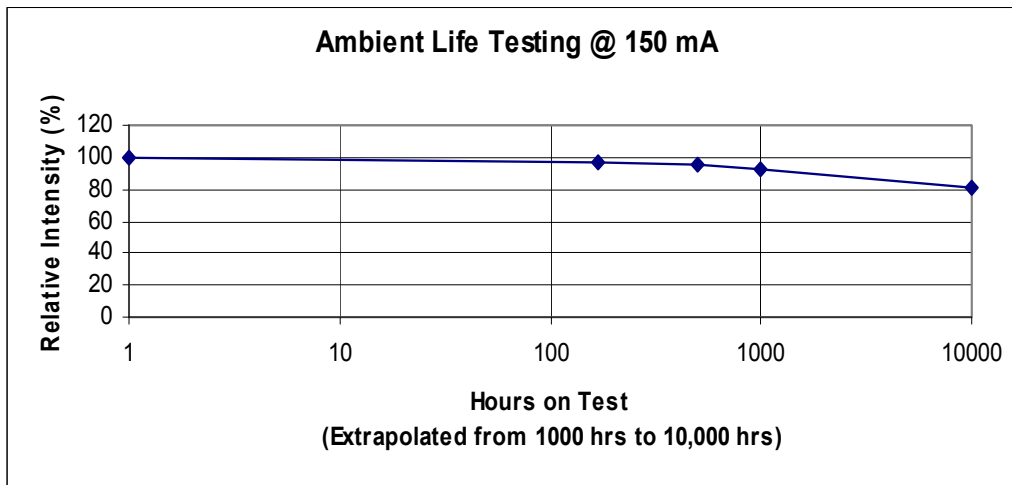

Failure Criteria (0 Failures)	
Electrical Fail Point	<ul style="list-style-type: none"> VF Shift > 20% of Initial Ir > 2X standard Limits 3 x IR Reflow Soldering @ 260°C / 10 second minimum @ max profile temp
Light Output Degradation	<ul style="list-style-type: none"> % IV Shift > 50% Average of Initial
Visual Failure Criteria	<ul style="list-style-type: none"> Broken or Damaged Package or Contacts Solderability < 95% Wetting Dimension Out of Tolerance

Conclusion: All Qualification Samples passed Failure Criteria

OPTEK reserves the right to make changes at any time in order to improve design and to supply the best product possible.

Radiation Pattern

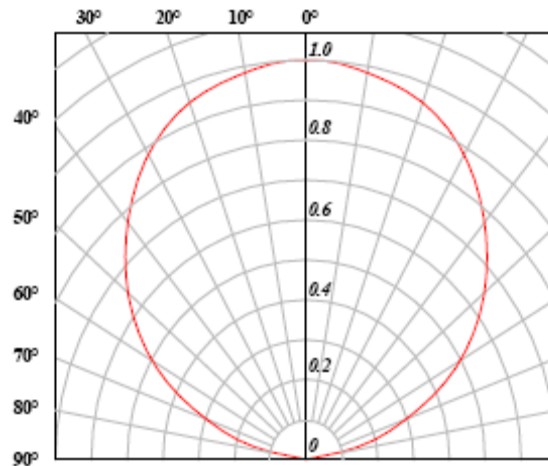

Solder Pad Design

Note: Metal core circuit board (MCPCB) is highly recommended for high density applications. FR-4 board is recommended for other applications

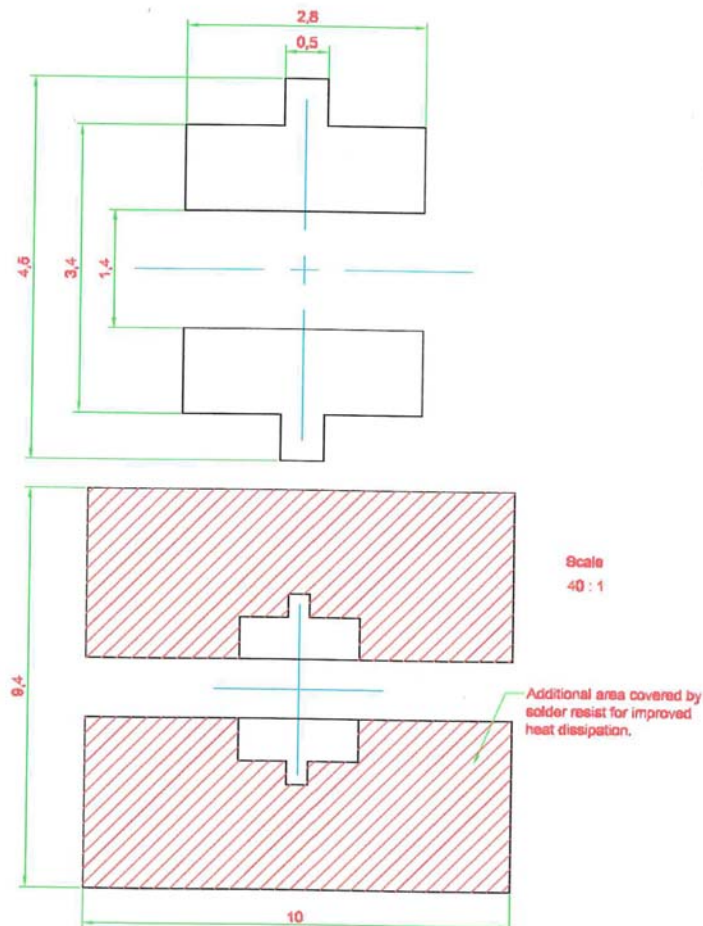

OPTEK reserves the right to make changes at any time in order to improve design and to supply the best product possible.

Recommended Sn-Pb IR-Reflow Soldering Profile.

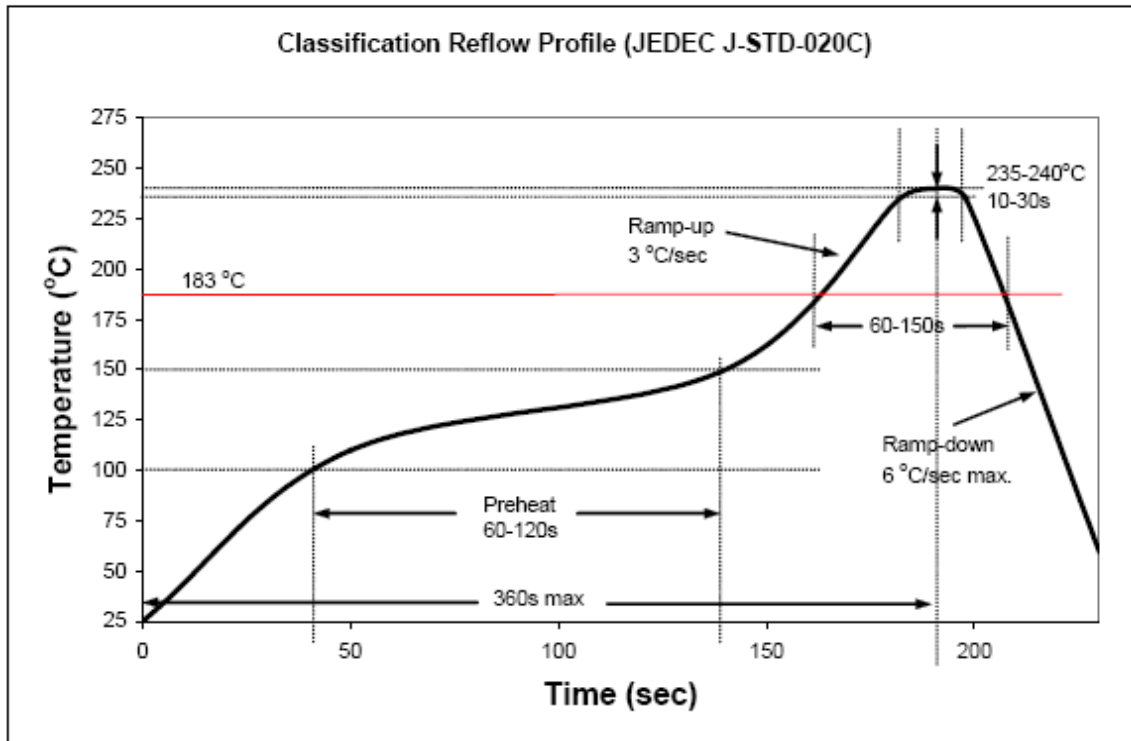

Recommended Pb Free IR-Reflow Soldering Profile.

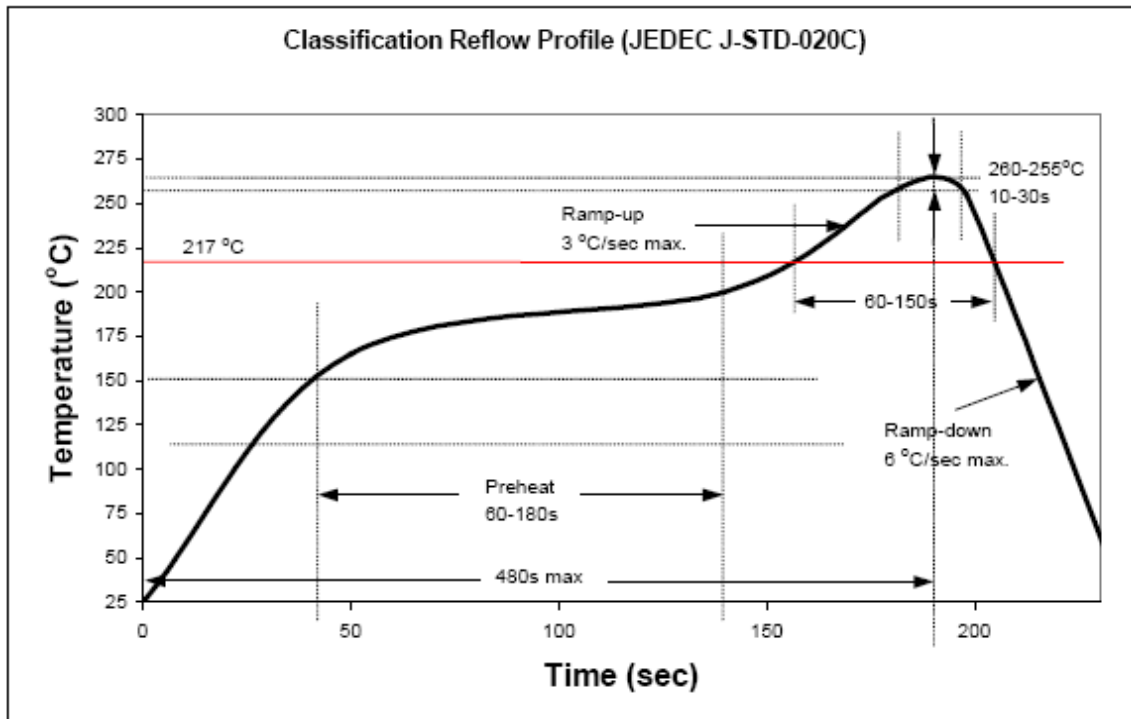

OPTeK reserves the right to make changes at any time in order to improve design and to supply the best product possible.

Mini half-watt SMD 3.5mm OVS5MxBCR4

Taping and Orientation

Loaded quantity 1000 pieces per reel
Reel Diameter is 180 mm / 7" reel

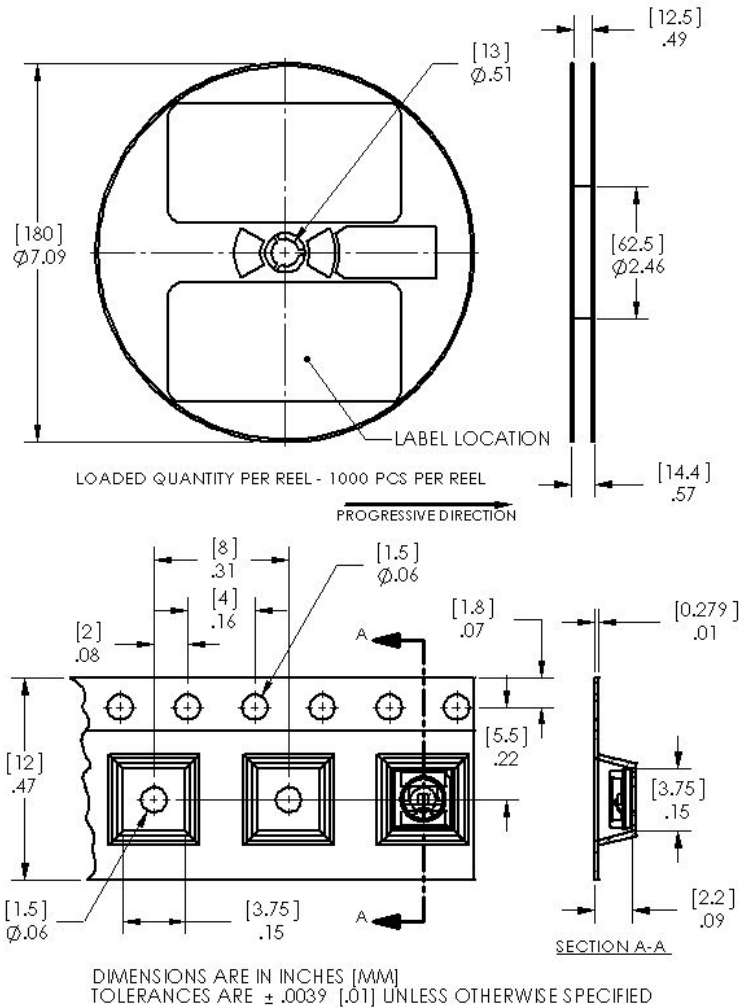

OPTEK reserves the right to make changes at any time in order to improve design and to supply the best product possible.