

Features

- * Integral current limiting resistor LED.
- * Chip resistor built in, required with 12 volts supply.
- * Cost effective (save external resistor space and cost)

Package Dimensions

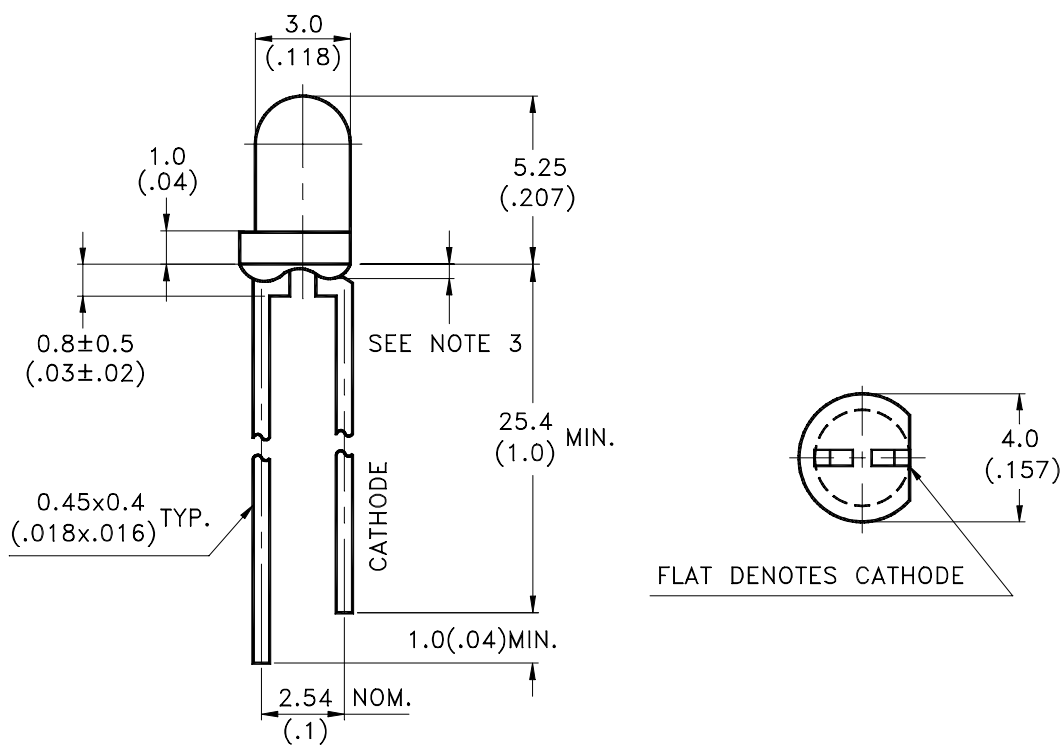

| Part No. | Lens | Source Color |
|--------------|-----------------|--------------|
| LTL-4251T-R2 | Yellow Diffused | Yellow |

Notes:

1. All dimensions are in millimeters (inches).
2. Tolerance is $\pm 0.25\text{mm}(.010\text{'})$ unless otherwise noted.
3. Protruded resin under flange is 1.0mm(.04") max.
4. Lead spacing is measured where the leads emerge from the package.
5. Specifications are subject to change without notice.

Absolute Maximum Ratings at TA=25°C

| Parameter | Maximum Rating | Unit |
|--|---------------------|------|
| DC Forward Voltage (TA=25°C) | 15 | V |
| Derating Linear From 50°C | 0.086 | V/°C |
| Reverse Voltage | 5 | V |
| Operating Temperature Range | -40°C to + 85°C | |
| Storage Temperature Range | -55°C to + 100°C | |
| Lead Soldering Temperature [1.6mm(.063") From Body] | 260°C for 5 Seconds | |

Equivalent circuit:

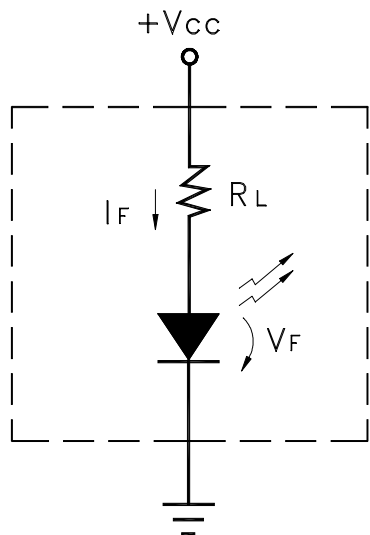

Vcc = 12 Volts
(RL = 800 ohms±20%)

$$I_F = \frac{V_{CC} - V_F}{R_L}$$



Electrical / Optical Characteristics at TA=25°C

| Parameter | Symbol | Min. | Typ. | Max. | Unit | Test Condition |
|--------------------------|-------------------|------|------|------|------|-----------------------------------|
| Luminous Intensity | I _v | 3.7 | 12.6 | | mcd | V _{CC} = 12V Note 1,4 |
| Viewing Angle | 2θ _{1/2} | | 40 | | deg | Note 2 (Fig.5) |
| Peak Emission Wavelength | λ _P | | 585 | | nm | Measurement @Peak (Fig.1) |
| Dominant Wavelength | λ _d | | 588 | | nm | Note 3 |
| Spectral Line Half-Width | Δλ | | 35 | | nm | |
| Forward Current | I _F | 8 | 12 | 16 | mA | V _{CC} = 12V |
| Reverse Current | I _R | | | 100 | μA | V _R = 5V |

- Note: 1. Luminous intensity is measured with a light sensor and filter combination that approximates the CIE (Commission International De L'Eclairage) eye-response curve.
2. θ_{1/2} is the off-axis angle at which the luminous intensity is half the axial luminous intensity.
3. The dominant wavelength, λ_d is derived from the CIE chromaticity diagram and represents the single wavelength which defines the color of the device.
4. The I_v guarantee should be added ± 15% .

Typical Electrical / Optical Characteristics Curves

(25°C Ambient Temperature Unless Otherwise Noted)

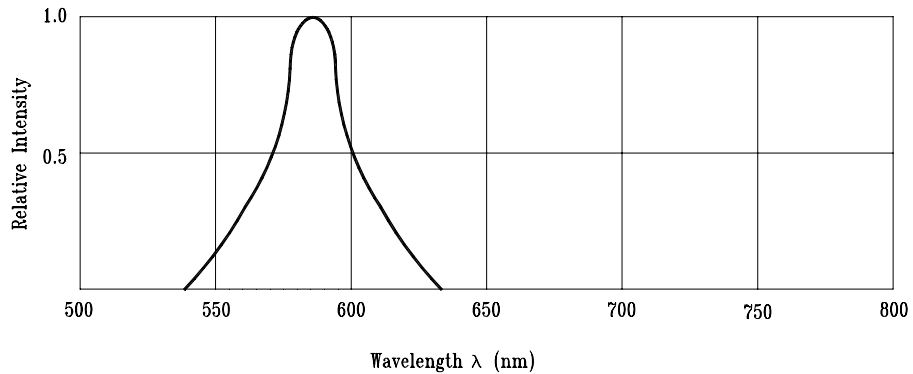

Fig.1 Relative Intensity vs. Wavelength

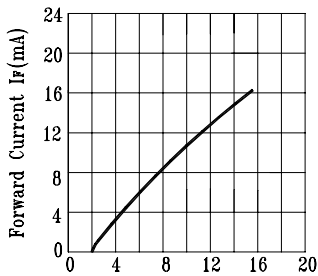

Fig.2 Forward Current vs. Applied Forward Voltage
12 Volts Devices

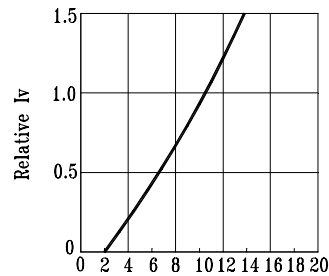

Fig.3 Relative Luminous Intensity vs. Applied Forward Voltage
12 Volts Devices

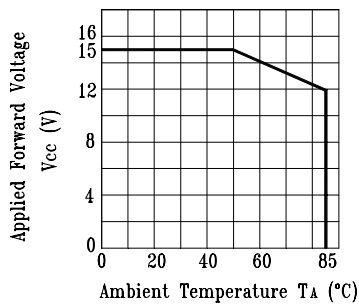

Fig.4. Maximum Allowed Applied Forward Voltage vs. Ambient Temperature
12 Volts Devices

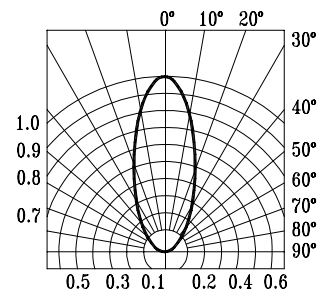

Fig.5 Spatial Distribution