

## Standard SMD LED PLCC-2

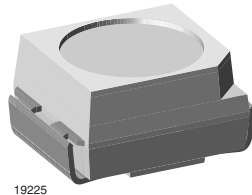

19225

### DESCRIPTION

These new devices have been designed to meet the increasing demand for surface mounting technology.

This device is used for outdoor or for low power applications.

The package of the TLMD310. is the PLCC-2 (equivalent to a size B tantalum capacitor).

It consists of a lead frame which is embedded in a white thermoplast. The reflector inside this package is filled up with clear epoxy.

### PRODUCT GROUP AND PACKAGE DATA

- Product group: LED
- Package: SMD PLCC-2
- Product series: standard
- Angle of half intensity:  $\pm 60^\circ$

### FEATURES

- SMD LEDs with exceptional brightness
- Luminous intensity categorized
- Compatible with automatic placement equipment
- EIA and ICE standard package
- Compatible with infrared, vapor phase and wave solder processes according to CECC
- Available in 8 mm tape
- Low profile package
- Non-diffused lens: excellent for coupling to light pipes and backlighting
- Low power consumption
- Luminous intensity ratio in one packaging unit  $I_{Vmax}/I_{Vmin} \leq 2.0$ , optional  $\leq 1.6$
- Lead (Pb)-free device



### APPLICATIONS

- Automotive: backlighting in dashboards and switches
- Telecommunication: indicator and backlighting in telephone and fax
- Indicator and backlight for audio and video equipment
- Indicator and backlight for battery driven equipment
- Small indicator for outdoor applications
- Indicator and backlight in office equipment
- Flat backlight for LCDs, switches and symbols
- General use

### PARTS TABLE

PART	COLOR, LUMINOUS INTENSITY	TECHNOLOGY
TLMD3100	Red, $I_V > 20$ mcd (typ.)	GaAIAs on GaAs
TLMD3101	Red, $I_V = (16 \text{ to } 50)$ mcd	GaAIAs on GaAs
TLMD3105	Red, $I_V = (10 \text{ to } 32)$ mcd	GaAIAs on GaAs

<b>ABSOLUTE MAXIMUM RATINGS<sup>1)</sup> TLMD310.</b>				
PARAMETER	TEST CONDITION	SYMBOL	VALUE	UNIT
Reverse voltage		$V_R$	6	V
DC Forward current		$I_F$	30	mA
Surge forward current	$t_p \leq 10 \mu\text{s}$	$I_{FSM}$	0.5	A
Power dissipation	$T_{amb} \leq 60 \text{ }^\circ\text{C}$	$P_V$	100	mW
Junction temperature		$T_j$	100	$^\circ\text{C}$
Operating temperature range		$T_{amb}$	- 40 to + 100	$^\circ\text{C}$
Storage temperature range		$T_{stg}$	- 55 to + 100	$^\circ\text{C}$
Soldering temperature	$t \leq 5 \text{ s}$	$T_{sd}$	260	$^\circ\text{C}$
Thermal resistance junction/ ambient	mounted on PC board (pad size > 16 mm <sup>2</sup> )	$R_{thJA}$	400	K/W

Note:

<sup>1)</sup>  $T_{amb} = 25 \text{ }^\circ\text{C}$ , unless otherwise specified

<b>OPTICAL AND ELECTRICAL CHARACTERISTICS<sup>1)</sup> TLMD310., RED</b>							
PARAMETER	TEST CONDITION	PART	SYMBOL	MIN	TYP.	MAX	UNIT
Luminous intensity <sup>3)</sup>	$I_F = 10 \text{ mA}$	TLMD3100	$I_V$	10	20		mcd
		TLMD3101	$I_V$	16		50	mcd
Luminous intensity <sup>2)</sup>	$I_F = 10 \text{ mA}$	TLMD3105	$I_V$	10		32	mcd
Luminous intensity	$I_F = 1 \text{ mA}$		$I_V$		2		mcd
Dominant wavelength	$I_F = 10 \text{ mA}$		$\lambda_d$		648		nm
Peak wavelength	$I_F = 10 \text{ mA}$		$\lambda_p$		650		nm
Angle of half intensity	$I_F = 10 \text{ mA}$		$\varphi$		$\pm 60$		deg
Forward voltage	$I_F = 20 \text{ mA}$		$V_F$		1.8	2.2	V
Reverse voltage	$I_R = 10 \mu\text{A}$		$V_R$	6	15		V
Junction capacitance	$V_R = 0, f = 1 \text{ MHz}$		$C_j$		15		pF

Note:

<sup>1)</sup>  $T_{amb} = 25 \text{ }^\circ\text{C}$ , unless otherwise specified

<sup>2)</sup> in one packing unit  $I_{Vmax}/I_{Vmin} \leq 1.6$

<sup>3)</sup> in one packing unit  $I_{Vmax}/I_{Vmin} \leq 2.0$

**TYPICAL CHARACTERISTICS**

$T_{amb} = 25\text{ }^{\circ}\text{C}$ , unless otherwise specified

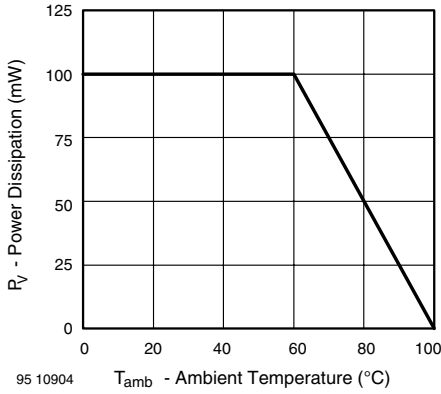

Figure 1. Power Dissipation vs. Ambient Temperature

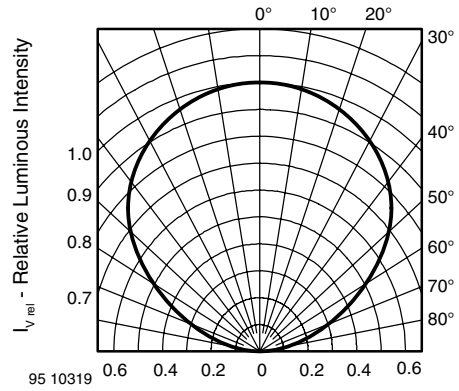

Figure 4. Rel. Luminous Intensity vs. Angular Displacement

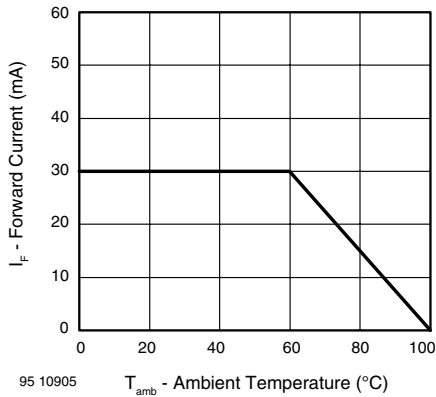

Figure 2. Forward Current vs. Ambient Temperature for InGaN

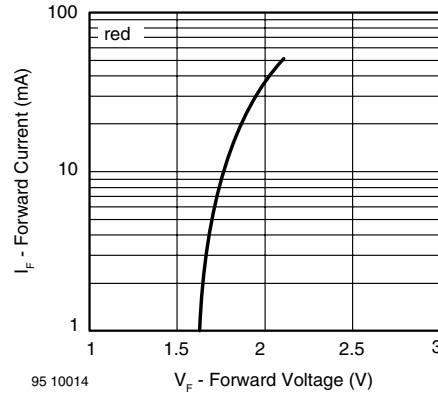

Figure 5.

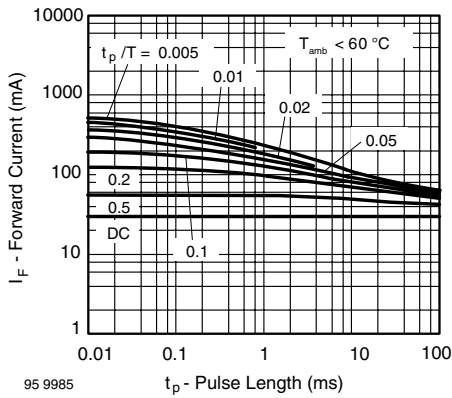

Figure 3. Pulse Forward Current vs. Pulse Duration

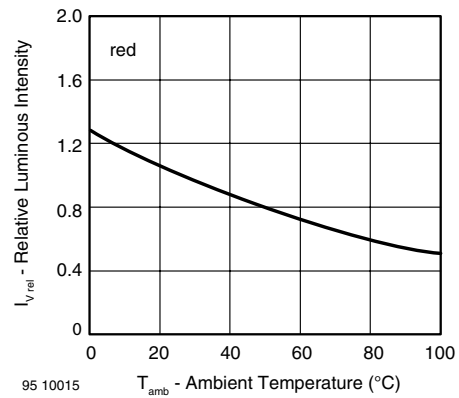

Figure 6. Rel. Luminous Intensity vs. Ambient Temperature

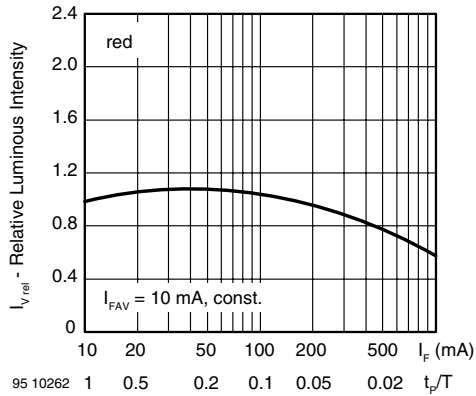

Figure 7. Rel. Lumin. Intensity vs. Forw. Current/Duty Cycle

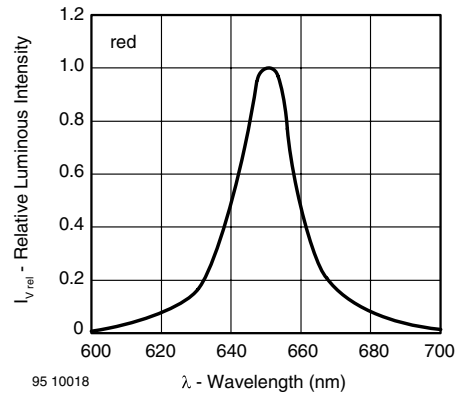

Figure 9. Relative Intensity vs. Wavelength

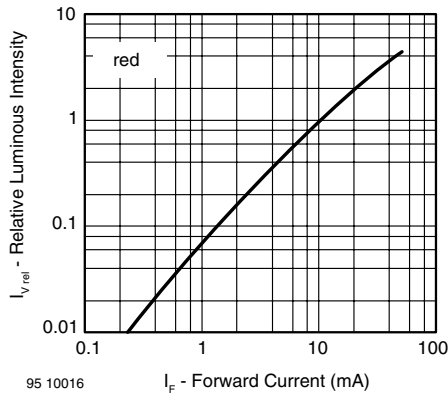
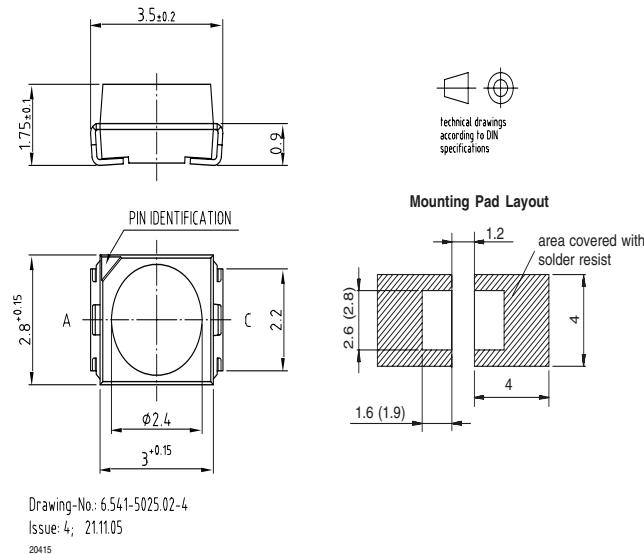

Figure 8. Relative Luminous Intensity vs. Forward Current

**PACKAGE DIMENSIONS** in millimeters





## Ozone Depleting Substances Policy Statement

It is the policy of Vishay Semiconductor GmbH to

1. Meet all present and future national and international statutory requirements.
2. Regularly and continuously improve the performance of our products, processes, distribution and operating systems with respect to their impact on the health and safety of our employees and the public, as well as their impact on the environment.

It is particular concern to control or eliminate releases of those substances into the atmosphere which are known as ozone depleting substances (ODSs).

The Montreal Protocol (1987) and its London Amendments (1990) intend to severely restrict the use of ODSs and forbid their use within the next ten years. Various national and international initiatives are pressing for an earlier ban on these substances.

Vishay Semiconductor GmbH has been able to use its policy of continuous improvements to eliminate the use of ODSs listed in the following documents.

1. Annex A, B and list of transitional substances of the Montreal Protocol and the London Amendments respectively
2. Class I and II ozone depleting substances in the Clean Air Act Amendments of 1990 by the Environmental Protection Agency (EPA) in the USA
3. Council Decision 88/540/EEC and 91/690/EEC Annex A, B and C (transitional substances) respectively.

Vishay Semiconductor GmbH can certify that our semiconductors are not manufactured with ozone depleting substances and do not contain such substances.

We reserve the right to make changes to improve technical design  
and may do so without further notice.

Parameters can vary in different applications. All operating parameters must be validated for each customer application by the customer. Should the buyer use Vishay Semiconductors products for any unintended or unauthorized application, the buyer shall indemnify Vishay Semiconductors against all claims, costs, damages, and expenses, arising out of, directly or indirectly, any claim of personal damage, injury or death associated with such unintended or unauthorized use.

Vishay Semiconductor GmbH, P.O.B. 3535, D-74025 Heilbronn, Germany



## Disclaimer

All product specifications and data are subject to change without notice.

Vishay Intertechnology, Inc., its affiliates, agents, and employees, and all persons acting on its or their behalf (collectively, "Vishay"), disclaim any and all liability for any errors, inaccuracies or incompleteness contained herein or in any other disclosure relating to any product.

Vishay disclaims any and all liability arising out of the use or application of any product described herein or of any information provided herein to the maximum extent permitted by law. The product specifications do not expand or otherwise modify Vishay's terms and conditions of purchase, including but not limited to the warranty expressed therein, which apply to these products.

No license, express or implied, by estoppel or otherwise, to any intellectual property rights is granted by this document or by any conduct of Vishay.

The products shown herein are not designed for use in medical, life-saving, or life-sustaining applications unless otherwise expressly indicated. Customers using or selling Vishay products not expressly indicated for use in such applications do so entirely at their own risk and agree to fully indemnify Vishay for any damages arising or resulting from such use or sale. Please contact authorized Vishay personnel to obtain written terms and conditions regarding products designed for such applications.

Product names and markings noted herein may be trademarks of their respective owners.