

# 4N25

## Phototransistor Optocoupler General Purpose Type



### Data Sheet



#### Description

The 4N25 is an optocoupler for general purpose applications. It contains a light emitting diode optically coupled to a photo-transistor. It is packaged in a 6-pin DIP package and available in wide-lead spacing option and lead bend SMD option. Response time,  $t_r$ , is typically 3  $\mu$ s and minimum CTR is 20% at input current of 10 mA.

#### Applications

- I/O interfaces for computers
- System appliances, measuring instruments
- Signal transmission between circuits of different potentials and impedances

#### Features

- Response time  
( $t_r$ : typ., 3  $\mu$ s at  $V_{CE} = 10$  V,  $I_C = 2$  mA,  $R_L = 100 \Omega$ )
- Current Transfer Ratio (CTR: min. 20% at  $I_F = 10$  mA,  $V_{CE} = 10$  V)
- Input-output isolation voltage ( $V_{iso} = 2500$  Vrms)
- Dual-in-line package
- UL approved
- CSA approved
- IEC/EN/DIN EN 60747-5-2 approved
- Options available:
  - Leads with 0.4" (10.16 mm) spacing (W00)
  - Leads bends for surface mounting (300)
  - Tape and reel for SMD (500)
  - IEC/EN/DIN EN 60747-5-2 approvals (060)

*CAUTION: It is advised that normal static precautions be taken in handling and assembly of this component to prevent damage and/or degradation which may be induced by ESD.*

4N25 is UL Recognized with 2500 Vrms for 1 minute per UL1577 and is approved under CSA Component Acceptance Notice #5, File CA 88324.

Part Number	RoHS Compliant Option	Package	Surface Mount	Gull Wing	Tape & Reel	IEC/EN/DIN EN 60747-5-2	Quantity
	Rank '0' 20%<CTR						
4N25	-000E	300 mil DIP-6					65 pcs per tube
	-300E	300 mil DIP-6	X	X			65 pcs per tube
	-500E	300 mil DIP-6	X	X	X		1000 pcs per reel
	-060E	300 mil DIP-6				X	65 pcs per tube
	-360E	300 mil DIP-6	X	X		X	65 pcs per tube
	-560E	300 mil DIP-6	X	X	X	X	1000 pcs per reel
	-W00E	400 mil DIP-6					65 pcs per tube
	-W60E	400 mil DIP-6				X	65 pcs per tube

To order, choose a part number from the part number column and combine with the desired option from the option column to form an order entry.

Example 1:

4N25-360E to order product of 300 mil DIP-6 DC Gull Wing Surface Mount package in Tube packaging with 20%<CTR, IEC/EN/DIN EN 60767-5-2 Safety Approval and RoHS compliant.

Example 2:

4N25-W00E to order product of 400 mil DIP-6 DC package in Tube packaging with 20%<CTR and RoHS compliant. Option data sheets are available. Contact your Avago sales representative or authorized distributor for information.

### Functional Diagram

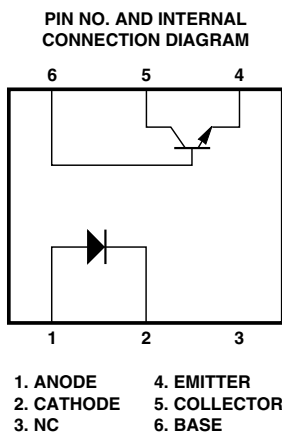

### Schematic

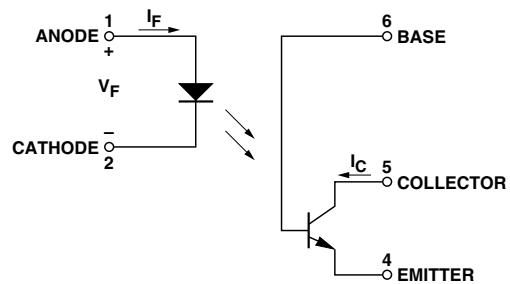

## Package Outline Drawings

### 4N25-000E

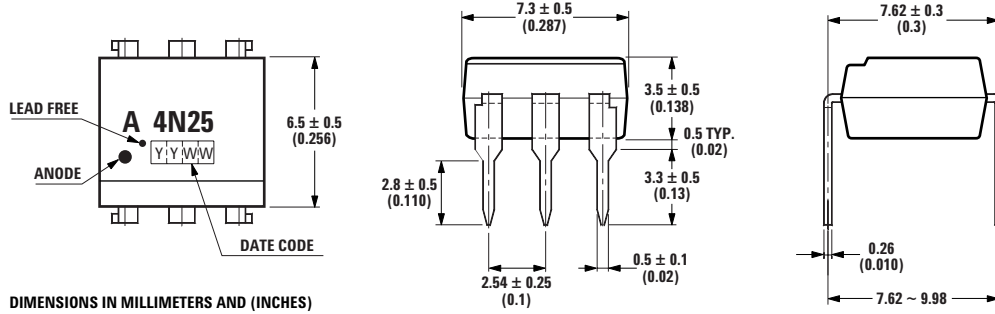

DIMENSIONS IN MILLIMETERS AND (INCHES)

### 4N25-060E

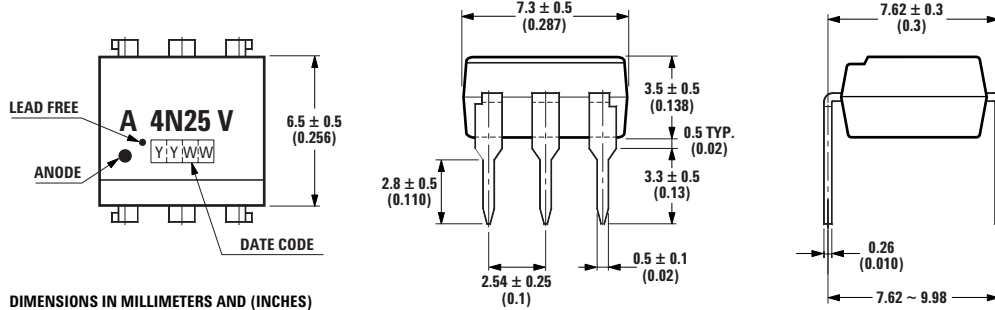

DIMENSIONS IN MILLIMETERS AND (INCHES)

### 4N25-W00E

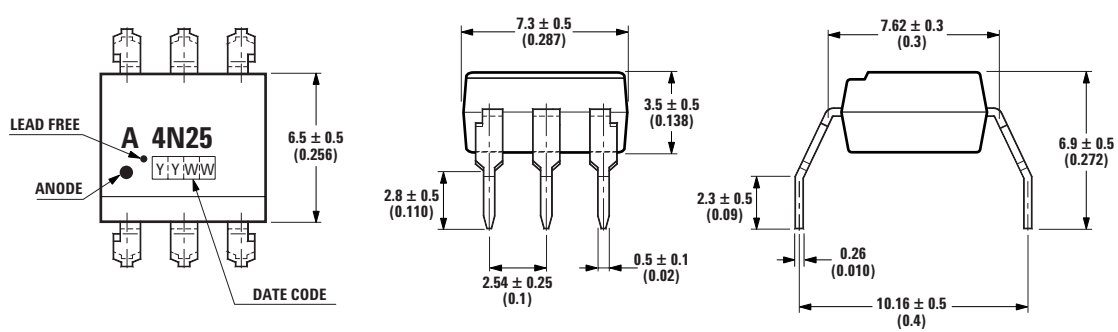

DIMENSIONS IN MILLIMETERS AND (INCHES)

### 4N25-300E

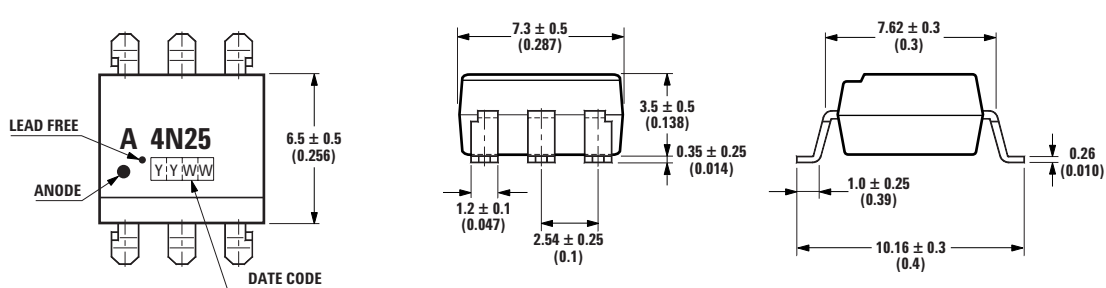

DIMENSIONS IN MILLIMETERS AND (INCHES)

### Solder Reflow Temperature Profile

1. One-time soldering reflow is recommended within the condition of temperature and time profile shown at right.
2. When using another soldering method such as infrared ray lamp, the temperature may rise partially in the mold of the device. Keep the temperature on the package of the device within the condition of (1) above.

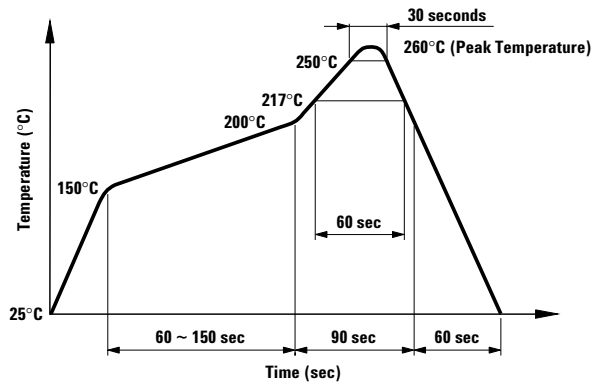

Note: Non-halide flux should be used.

### Absolute Maximum Ratings

Storage Temperature, $T_S$	-55°C to +150°C
Operating Temperature, $T_A$	-55°C to +100°C
Lead Solder Temperature, max. (1.6 mm below seating plane)	260°C for 10 s
Average Forward Current, $I_F$	80 mA
Reverse Input Voltage, $V_R$	6 V
Input Power Dissipation, $P_I$	150 mW
Collector Current, $I_C$	100 mA
Collector-Emitter Voltage, $V_{CE0}$	30 V
Emitter-Collector Voltage, $V_{EC0}$	7 V
Collector-Base Voltage, $V_{CB0}$	70 V
Collector Power Dissipation	150 mW
Total Power Dissipation	250 mW
Isolation Voltage, $V_{iso}$ (AC for 1 minute, R.H. = 40 ~ 60%)	2500 Vrms

### Electrical Specifications (T<sub>A</sub> = 25°C)

Parameter	Symbol	Min.	Typ.	Max.	Units	Test Conditions
Forward Voltage	V <sub>F</sub>	–	1.2	1.5	V	I <sub>F</sub> = 10 mA
Reverse Current	I <sub>R</sub>	–	–	10	μA	V <sub>R</sub> = 4 V
Terminal Capacitance	C <sub>t</sub>	–	50	–	pF	V = 0, f = 1 KHz
Collector Dark Current	I <sub>CEO</sub>	–	–	50	nA	V <sub>CE</sub> = 10 V, I <sub>F</sub> = 0
Collector-Emitter Breakdown Voltage	BV <sub>CEO</sub>	30	–	–	V	I <sub>C</sub> = 0.1 mA, I <sub>F</sub> = 0
Emitter-Collector Breakdown Voltage	BV <sub>ECO</sub>	7	–	–	V	I <sub>E</sub> = 10 μA, I <sub>F</sub> = 0
Collector-Base Breakdown Voltage	BV <sub>CBO</sub>	70	–	–	V	I <sub>C</sub> = 0.1 mA, I <sub>F</sub> = 0
Collector Current	I <sub>C</sub>	2	–	–	mA	I <sub>F</sub> = 10 mA
*Current Transfer Ratio	CTR	20	–	–	%	V <sub>CE</sub> = 10 V
Collector-Emitter Saturation Voltage	V <sub>CE(sat)</sub>	–	0.1	0.5	V	I <sub>F</sub> = 50 mA, I <sub>C</sub> = 2 mA
Response Time (Rise)	t <sub>r</sub>	–	3	–	μs	V <sub>CE</sub> = 10 V, I <sub>C</sub> = 2 mA
Response Time (Fall)	t <sub>f</sub>	–	3	–	μs	R <sub>L</sub> = 100 Ω
Isolation Resistance	R <sub>iso</sub>	5 x 10 <sup>10</sup>	1 x 10 <sup>11</sup>	–	Ω	DC 500 V 40 ~ 60% R.H.
Floating Capacitance	C <sub>f</sub>	–	1	–	pF	V = 0, f = 1 MHz

$$* \text{CTR} = \frac{I_C}{I_F} \times 100\%$$

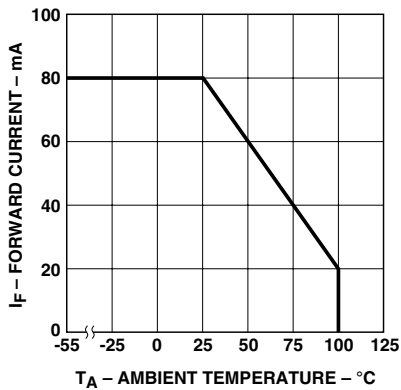

Figure 1. Forward current vs. temperature.

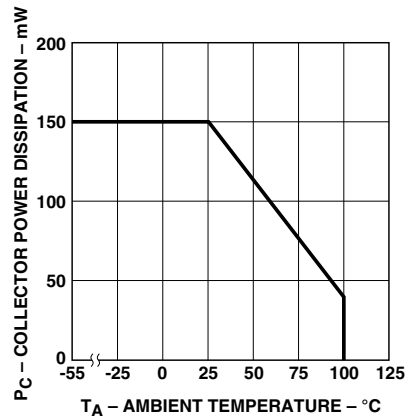

Figure 2. Collector power dissipation vs. temperature.

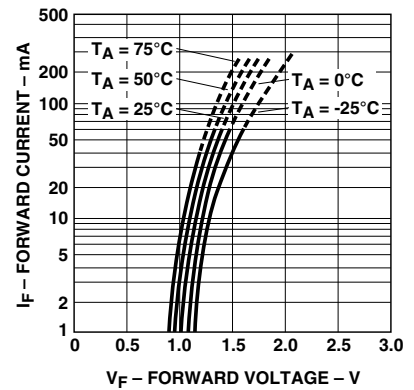

Figure 3. Forward current vs. forward voltage.

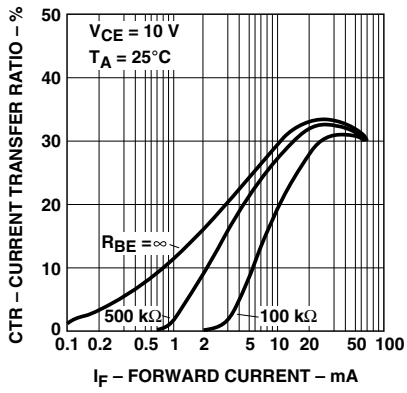

Figure 4. Current transfer ratio vs. forward current.

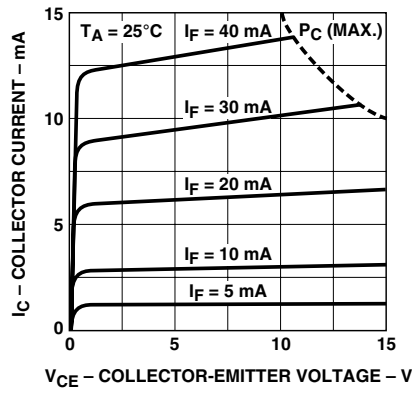

Figure 5. Collector current vs. collector-emitter voltage.

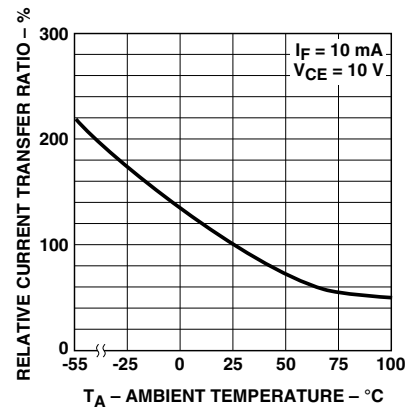

Figure 6. Relative current transfer ratio vs. temperature.

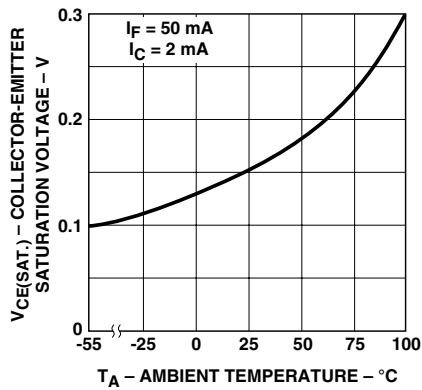

Figure 7. Collector-emitter saturation voltage vs. temperature.

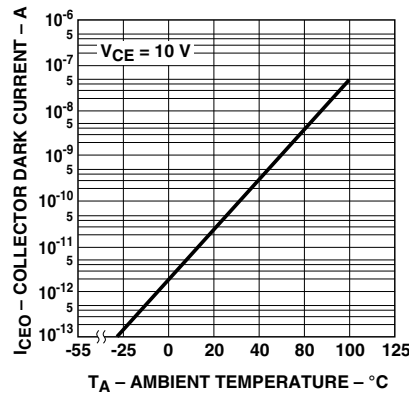

Figure 8. Collector dark current vs. temperature.

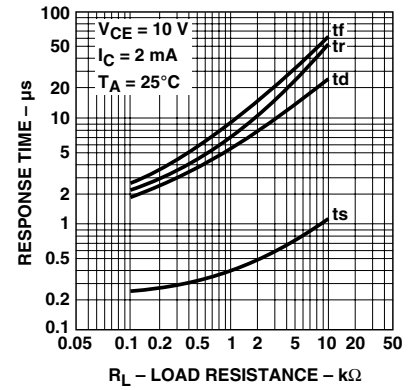

Figure 9. Response time vs. load resistance.

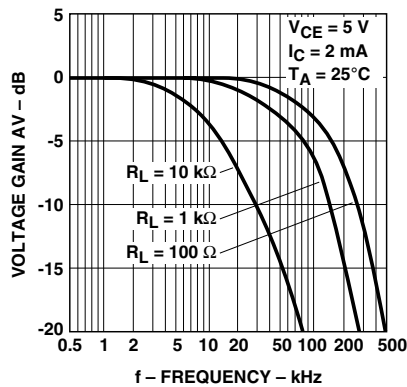

Figure 10. Frequency response.

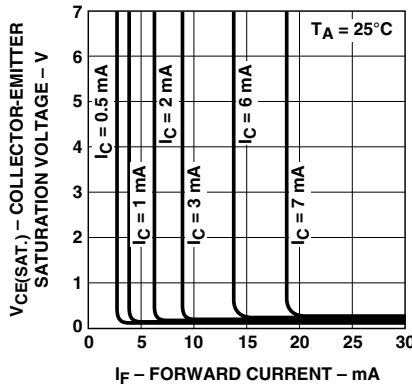
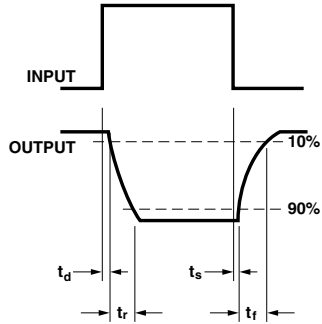
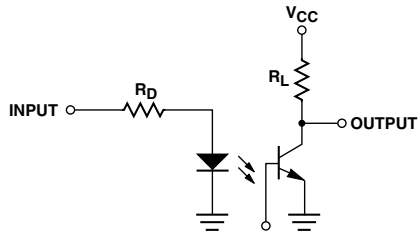
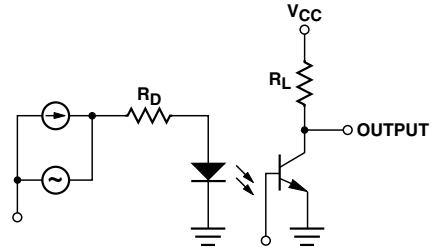

Figure 11. Collector-emitter saturation voltage vs. forward current.

### Test Circuit for Response Time



### Test Circuit for Frequency Response



For product information and a complete list of distributors, please go to our website: [www.avagotech.com](http://www.avagotech.com)

Avago, Avago Technologies, and the A logo are trademarks of Avago Technologies Limited in the United States and other countries. Data subject to change. Copyright © 2007 Avago Technologies Limited. All rights reserved. Obsoletes 5989-1733EN AV02-0412EN - October 18, 2007

**Avago**  
TECHNOLOGIES