

REV.	DESCRIPTION	DATE	APPROVED
B	Engineering Update, Corrected $\Delta\lambda$	03/10/04	M. C.
C	Electrical/Optical Characteristics Added.	01/03/06	M. C.
D	Specification Update, EMN-UVLED1	08/21/06	M. C.
E	Updated Specs	10/20/08	T.Y.

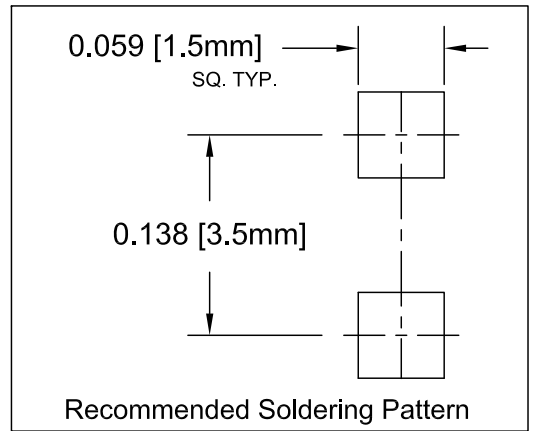
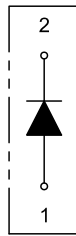
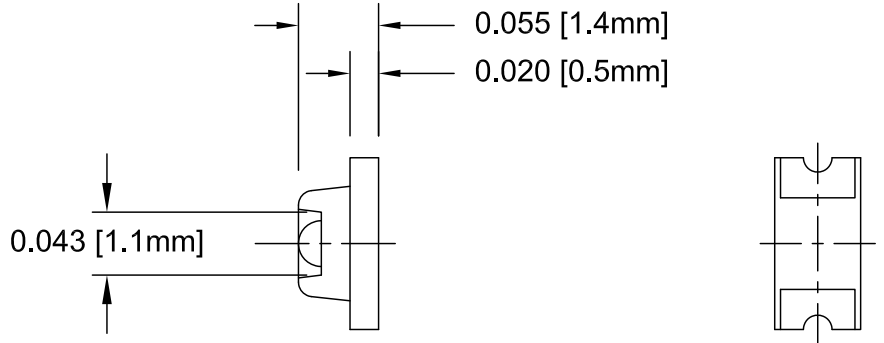
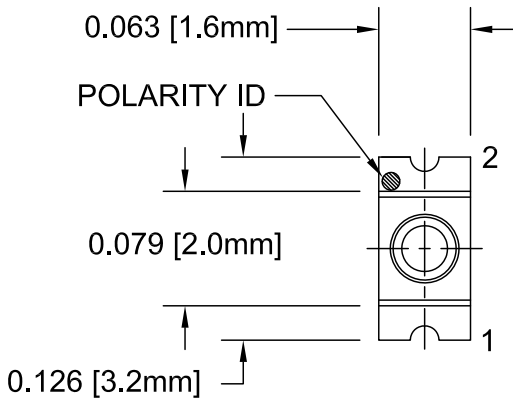

CAUTIONS: EMITS ULTRAVIOLET RADIATION!!
 This device radiates intense ultraviolet (UV) light when operated. Exposure to UV radiation can be harmful to your health. Protect your eyes and skin during operation.
 Do not look directly at this device during operation. Exposure to UV light, even for a brief period, can damage your eyes.
 Do not operate the device unless you have had proper safety training and take appropriate precautions.
 Do not permit children or untrained personnel to operate the device.

ABSOLUTE MAXIMUM RATINGS (Ta=25°C)

ELECTROSTATIC DISCHARGE THRESHOLD (HBM)	_____	1000V
ELECTROSTATIC DISCHARGE CLASSIFICATION (MIL-STD-883E)	_____	CLASS 2 (CLASS 1 FOR UV)
LED JUNCTION TEMPERATURE	_____	125°C
REVERSE VOLTAGE	_____	5V
REVERSE CURRENT (V _R = 5V)	_____	10µA
OPERATING TEMPERATURE RANGE	_____	-30°C ~ 80°C
STORAGE TEMPERATURE	_____	-40°C ~ 85°C
LEAD SOLDERING TEMPERATURE(1/16" FROM BODY)	_____	260°C FOR 5 SECONDS



STANDARD TOLERANCE (UNLESS OTHERWISE SPECIFIED)		 4 THOMAS, IRVINE, CA, 92618 TEL: (949) 951-8808 FAX: (949) 951-3974			
DECIMALS	ANGULAR				
.X ±.1	X° ±1°	TITLE: SURFACE MOUNT LED, 1206 PACKAGE, UV			
.XX ±.02					
.XXX ±.010		DESIGNED: David Green	DATE: 05/19/03	PART NO: SM1206UV-XXX-IL	REVISION: E
CHECKED: T. Yin	DATE: 05/19/03	CAGE CODE : 32559	SHEET # 1 OF 5		
CAD GENERATED DOCUMENT, DO NOT MEASURE DRAWING.					

REV.	DESCRIPTION	DATE	APPROVED
	SEE SHEET#1.		

LED Part No.	Chip				Lens Appearance	Absolute Max. Ratings			Electro-Optical Data @ 20mA				Viewing Angle 2 θ 1/2 (Deg)
	Material	Emitted Color	Length λ_p (nm)			Pd (mW)	If (Typ) (mA)	Peak If(mA)	Vf (V)		Rad. Flux P(mW)	Optical Rise Time (t,ns)	
			MIN	MAX					TYP	MAX			
SM1206UV-395-IL	InGaNSiC	BLUE UV	395	400	WATER CLEAR	100	25	100	3.4	4.2	11.0	30.0	30
SM1206UV-405-IL	InGaNSiC	BLUE UV	405	410	WATER CLEAR	100	25	100	3.4	4.2	12.0	30.0	30

NOTES:

- Product resistance to electrostatic discharge (ESD) is measured by simulating ESD using a rapid avalanche energy test (RAET). The RAET procedures are designed to approximate the maximum ESD ratings shown. Seller gives no other assurances regarding the ability of Products to withstand ESD.
- LED power rating is the average power rating for the LEDs 1,000 hour lifespan.
- Driving LEDs at greater than the recommended current will increase the degradation of the LED.

STANDARD TOLERANCE (UNLESS OTHERWISE SPECIFIED) <small>±10% ALL VALUES ANGULAR</small>		 4 THOMAS, IRVINE, CA, 92618 TEL: (949) 951-8808 FAX: (949) 951-3974	
			
		DESIGNED: David Green	DATE: 05/19/03
CHECKED: M. Chen	DATE: 05/19/03	CAGE CODE : 32559	SHEET # 2 OF 5
CAD GENERATED DOCUMENT. DO NOT MEASURE DRAWING.			

REV.	DESCRIPTION	DATE	APPROVED
	SEE SHEET#1.		

RELIABILITY TEST RESULTS

NO.	Item	Test Conditions	Test Hours / Cycle	Sample Q'ty	Ac / Re
1	Solder Heat	TEMP : 260°C±5°C	5 sec	36 pcs	0 / 1
2	Temperature Cycle	H : +100°C 30min. ∫ 5min. L : -40°C 30min.	50 cycle	36 pcs	0 / 1
3	Thermal Shock	H : +100°C 5min. ∫ 10sec L : -40°C 5min.	50 cycle	36 pcs	0 / 1
4	High Temperature Storage	TEMP : 100°C	1000 hrs	36 pcs	0 / 1
5	Low Temperature Storage	TEMP : -40°C	1000 hrs	36 pcs	0 / 1
6	DC Operating Life	I _F = 20mA	1000 hrs	36 pcs	0 / 1
7	High Temperature / High Humidity	85°C / 90~95%R.H.	1000 hrs	36 pcs	0 / 1

STANDARD TOLERANCE (UNLESS OTHERWISE SPECIFIED) ±10% ALL VALUES ANGULAR		BIVAR [®] 4 THOMAS, IRVINE, CA, 92618 TEL: (949) 951-8808 FAX: (949) 951-3974	
		TITLE: SURFACE MOUNT LED, 1206 PACKAGE, UV	
		DESIGNED: David Green	DATE: 05/19/03
CHECKED: M. Chen		DATE: 05/19/03	CAGE CODE : 32559 SHEET # 3 OF 5
CAD GENERATED DOCUMENT, DO NOT MEASURE DRAWING.			

REV.	DESCRIPTION	DATE	APPROVED
	SEE SHEET#1.		

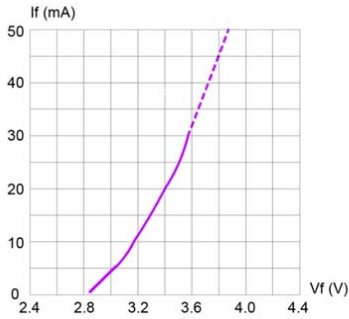

Fig. 1 Forward Current vs. Forward Voltage

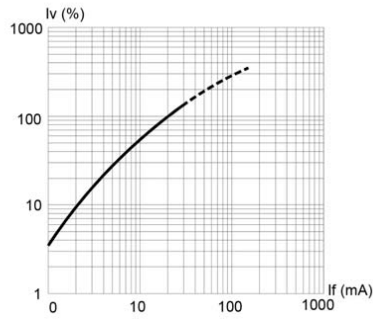

Fig. 2 Relative Luminous Intensity vs. Forward Current

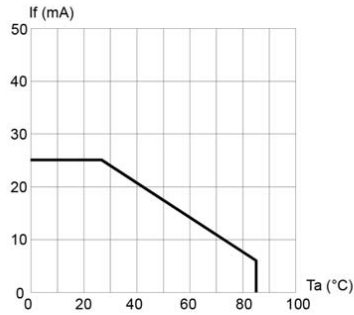

Fig. 3 Forward Current vs. Temperature

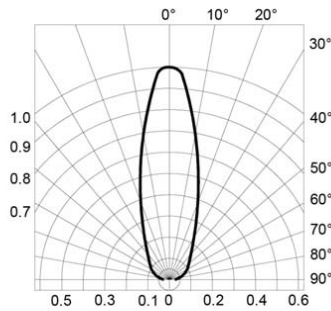

Fig. 4 Directivity Radiation Diagram

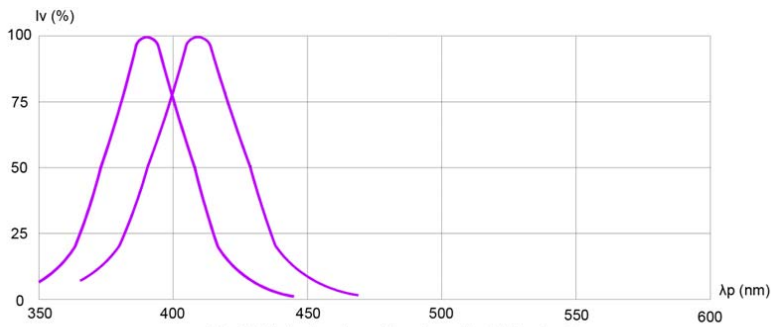
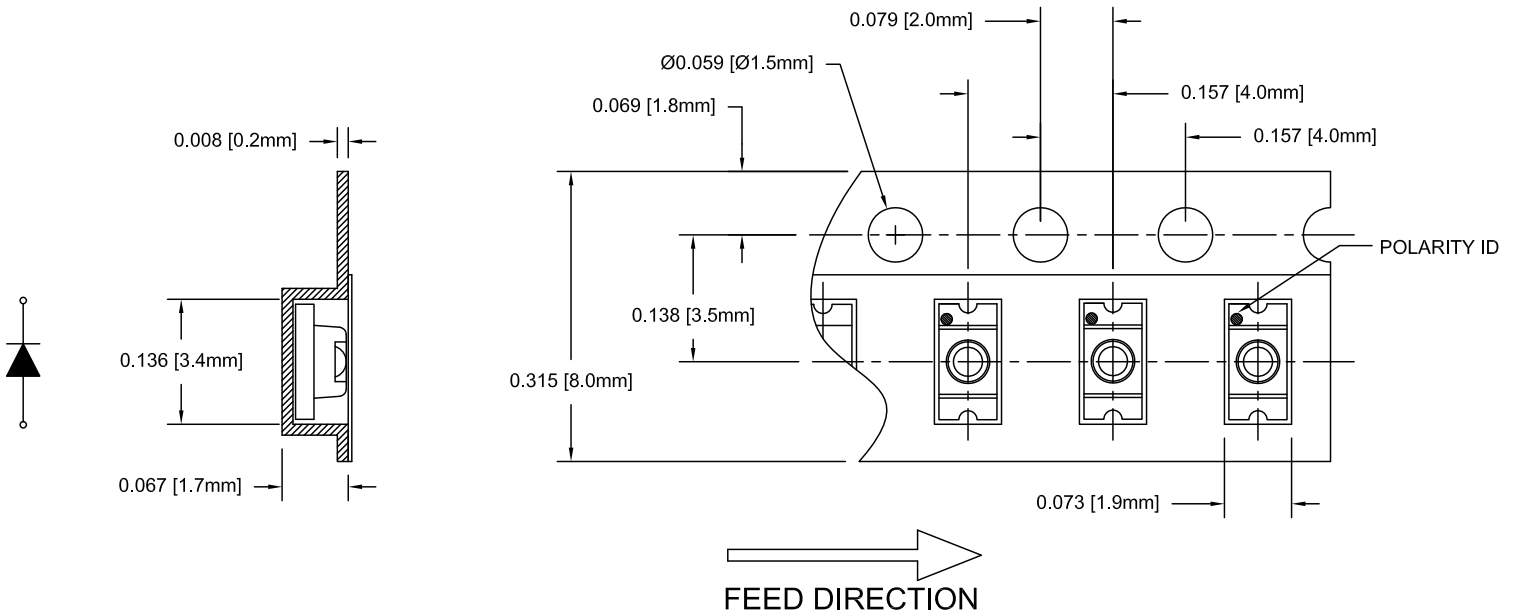



Fig. 5 Relative Luminous Intensity vs. Peak Wavelength

STANDARD TOLERANCE (UNLESS OTHERWISE SPECIFIED) ±10% ALL VALUES		ANGULAR		 4 THOMAS, IRVINE, CA, 92618 TEL: (949) 951-8808 FAX: (949) 951-3974	
DESIGNED: David Green		DATE: 05/19/03		TITLE: SURFACE MOUNT LED, 1206 PACKAGE, UV	
CHECKED: M. Chen		DATE: 05/19/03		PART NO: SM1206UV-XXX-IL	
				REVISION: E	
				CAGE CODE : 32559	
				SHEET # 4 OF 5	
CAD GENERATED DOCUMENT, DO NOT MEASURE DRAWING.					

REV.	DESCRIPTION	DATE	APPROVED
	SEE SHEET#1.		



2. UNLESS OTHERWISE SPECIFIED,
PACKAGING TO COMPLY WITH EIA-481-B
1. 3000 pcs PER REEL

STANDARD TOLERANCE (UNLESS OTHERWISE SPECIFIED) ±10% ALL VALUES		ANGULAR X° ± 5°		 BIVAR 4 THOMAS, IRVINE, CA, 92618 TEL: (949) 951-8808 FAX: (949) 951-3974
.X ± .1	.XX ± .02	.XXX ± .010		
DESIGNED: David Green	DATE: 05/19/03	PART NO: SM1206UV-XXX-IL		REVISION: E
CHECKED: M. Chen	DATE: 05/19/03	CAGE CODE : 32559	SHEET # 5 OF 5	
CAD GENERATED DOCUMENT. DO NOT MEASURE DRAWING.				