

Cree® PLCC4 3-in-1 SMD LED

CLPPA-FKB

Data Sheet

These SMD LEDs are packaged in an industry-standard PLCC4 package. These high-reliability and high-brightness LEDs are designed to work in a wide range of environmental conditions. A wide viewing angle and high brightness makes these LEDs suitable for indoor signage applications.

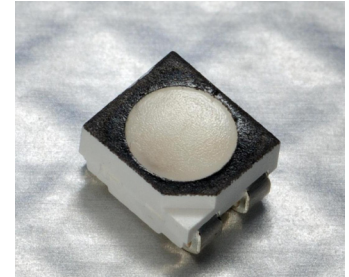

FEATURES

- Size (mm): 3.2 x 2.8
- Dominant Wavelength (nm):
 - » Red (612-622)
 - » Green (520-540)
 - » Blue (460-480)
- Luminous Intensity (mcd)
 - » Red (180-450)
 - » Green (280-710)
 - » Blue (71-180)
- Lead-Free
- RoHS-Compliant

APPLICATIONS

- Full-Color Video Screen
- Decorative lighting
- Amusement



Absolute Maximum Ratings ($T_A = 25^\circ\text{C}$)

Items	Symbol	Absolute Maximum Rating			Unit
		R	G	B	
Forward Current ^{Note 1}	I_F	50	25	25	mA
Peak Forward Current ^{Note 2}	I_{FP}	200	100	100	mA
Reverse Voltage	V_R	5	5	5	V
Power Dissipation	P_D	125	100	100	mW
Operation Temperature	T_{opr}	-40 ~ +100			$^\circ\text{C}$
Storage Temperature	T_{stg}	-40 ~ +100			$^\circ\text{C}$
Junction Temperature	T_J	110	110	110	$^\circ\text{C}$
Junction/ambient 1 chip on	R_{THJA}	450	400	450	$^\circ\text{C}/\text{W}$
Junction/ambient 3 chips on	R_{THJA}	650	580	680	$^\circ\text{C}/\text{W}$
Junction/solder point 1 chip on	R_{THJS}	300	280	300	$^\circ\text{C}/\text{W}$
Junction/solder point 3 chips on	R_{THJS}	450	430	480	$^\circ\text{C}/\text{W}$

Notes:

1. Single-color light.
2. Pulse width ≤ 0.1 msec, duty $\leq 1/10$.

Typical Electrical & Optical Characteristics ($T_A = 25^\circ\text{C}$)

Characteristics	Condition	Symbol	Values			Unit
			R	G	B	
Wavelength at peak emission	$I_F = 20$ mA	λ_{PEAK}	620	520	465	nm
Dominant Wavelength	$I_F = 20$ mA	λ_{DOM}	612~622	520~540	460~480	nm
Spectral bandwidth at 50% I_{REL} max	$I_F = 20$ mA	$\Delta \lambda$	24	38	28	nm
Viewing Angle at 50% I_V	$I_F = 20$ mA	$2\theta_{1/2}$	120	120	120	deg
Forward Voltage	$I_F = 20$ mA	$V_{F(avg)}$	2.0	3.4	3.4	V
		$V_{F(max)}$	2.5	4.0	4.0	V
Luminous Intensity	$I_F = 20$ mA	$I_{V(min)}$	180	280	71	mcd
		$I_{V(avg)}$	300	450	110	mcd
Reverse Current (max)	$V_R = 5$ V	I_R	10	10	10	μA



Intensity Bin Limit ($I_F = 20 \text{ mA}$)

Red

Bin Code	Min. (mcd)	Max. (mcd)
E	180	224
F	224	280
G	280	355
H	355	450

Green

Bin Code	Min. (mcd)	Max. (mcd)
G	280	355
H	355	450
J	450	560
K	560	710

Blue

Bin Code	Min. (mcd)	Max. (mcd)
A	71.0	90.0
B	90.0	112
C	112	140
D	140	180

Tolerance of measurement of luminous intensity is $\pm 10\%$.

Color Bin Limit ($I_F = 20 \text{ mA}$)

Red

Bin Code	Min. (nm)	Max. (nm)
PE	612	622

Green

Bin Code	Min. (nm)	Max. (nm)
G7	520	525
G8	525	530
G9	530	535
Ga	535	540

Blue

Bin Code	Min. (nm)	Max. (nm)
B3	460	465
B4	465	470
B5	470	475
B6	475	480

Tolerance of measurement of dominant wavelength is $\pm 1 \text{ nm}$.



Order Code Table*

Kit Number	Color	Luminous Intensity (mcd)		Dominant Wavelength (nm)				Package
		Min.	Max.	Color Bin	Min. (nm)	Color Bin	Max. (nm)	
CLPPA-FKB-CEHGKADEE7a363	Red	180	450	PE	612	PE	622	Reel
	Green	280	710	G7	520	Ga	540	Reel
	Blue	71	180	B3	460	B6	480	Reel

Notes:

- The above kit numbers represent order codes that include multiple intensity-bin and color-bin codes. Only one intensity-bin code and one color-bin code will be shipped on each reel. Single intensity-bin codes and single color-bin codes will not be orderable. For example, any one intensity bin from E - H means only one intensity (E or F or G or H) will be shipped by Cree. Any one color bin from G8 - Ga means only one color bin (G8 or G9 or Ga) will be shipped by Cree.
- Please refer to the "Cree LED Lamp Reliability Test Standards" document for reliability test conditions.
- Please refer to the "Cree LED Lamp Soldering & Handling" document for information about how to use this LED product safely.

Graphs

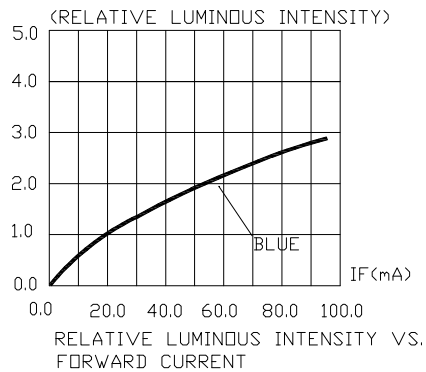
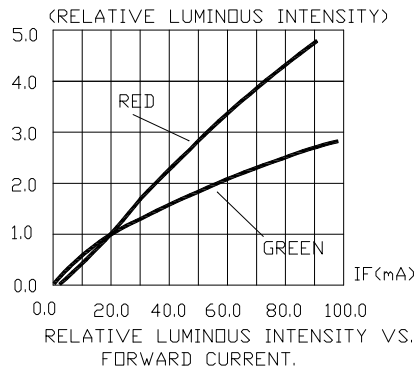
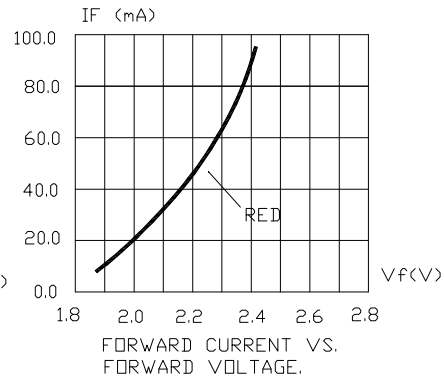
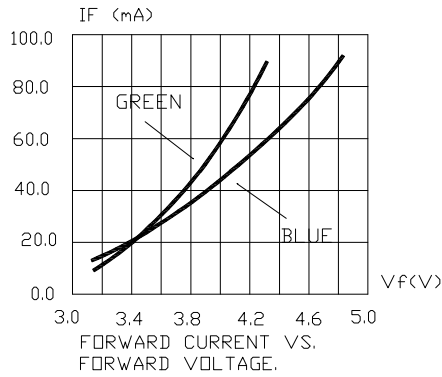
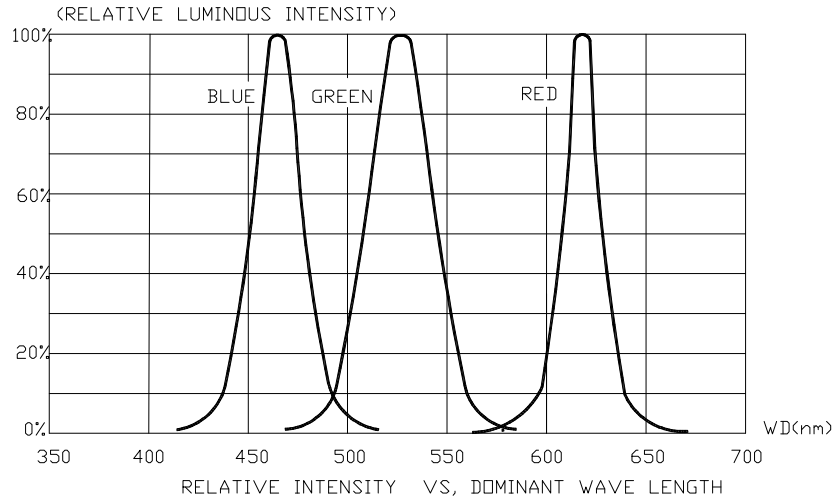

The above data are collected from statistical figures that do not necessarily correspond to the actual parameters of each single LED. Hence, these data will be changed without further notice.

Graphs

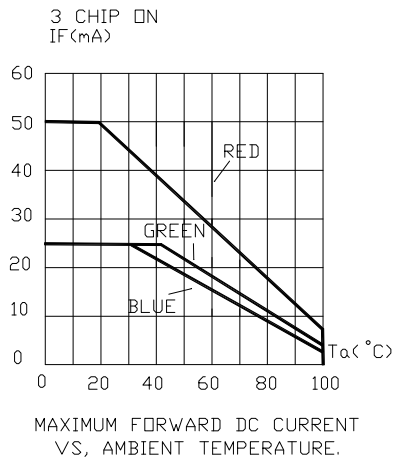
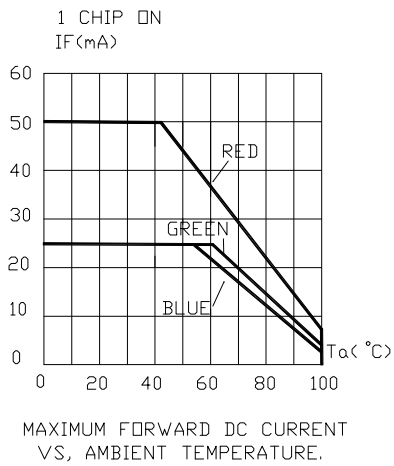
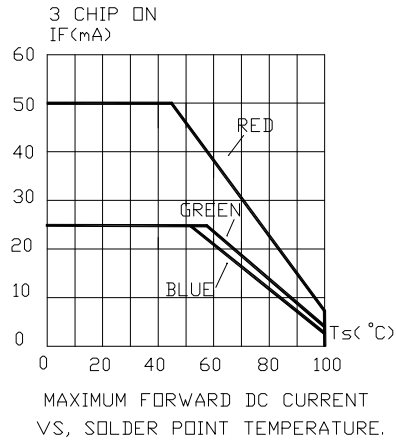
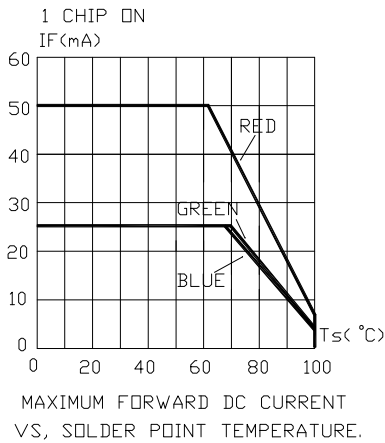
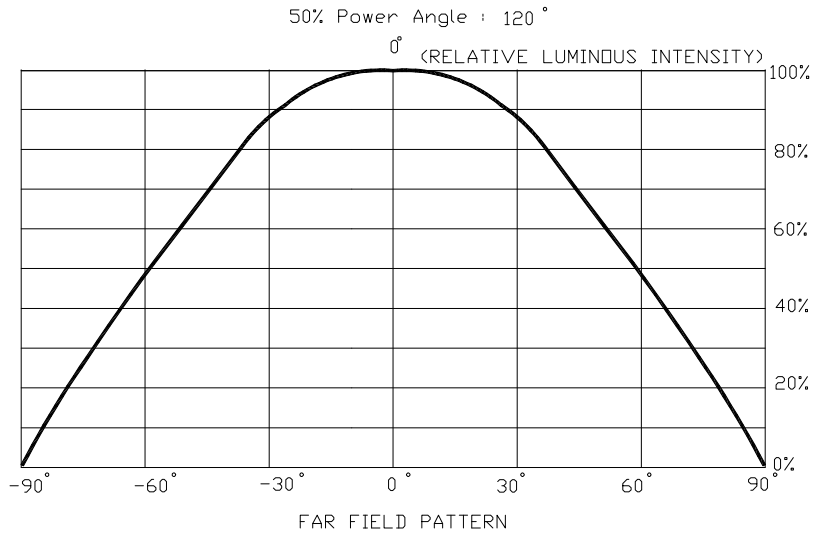

The above data are collected from statistical figures that do not necessarily correspond to the actual parameters of each single LED. Hence, these data will be changed without further notice.

Mechanical Dimensions

All dimensions are in mm.

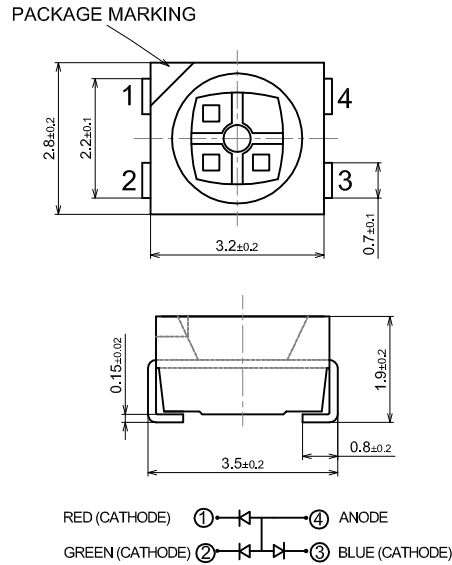

Notes

RoHS Compliance

The levels of environmentally sensitive, persistent biologically toxic (PBT), persistent organic pollutants (POP), or otherwise restricted materials in this product are below the maximum concentration values (also referred to as the threshold limits) permitted for such substances, or are used in an exempted application, in accordance with EU Directive 2002/95/EC on the restriction of the use of certain hazardous substances in electrical and electronic equipment (RoHS), as amended through April 21, 2006.

Vision Advisory Claim

Users should be cautioned not to stare at the light of this LED product. The bright light can damage the eye.

Kit Number System

Cree LED lamps are tested and sorted into performance bins. A bin is specified by ranges of color, forward voltage, and brightness. Sorted LEDs are packaged for shipping in various convenient options. Please refer to the "Cree LED Lamp Packaging Standard" document for more information about shipping and packaging options.

Cree LEDs are sold by order codes in combinations of bins called kits. Order codes are configured in the following manner:

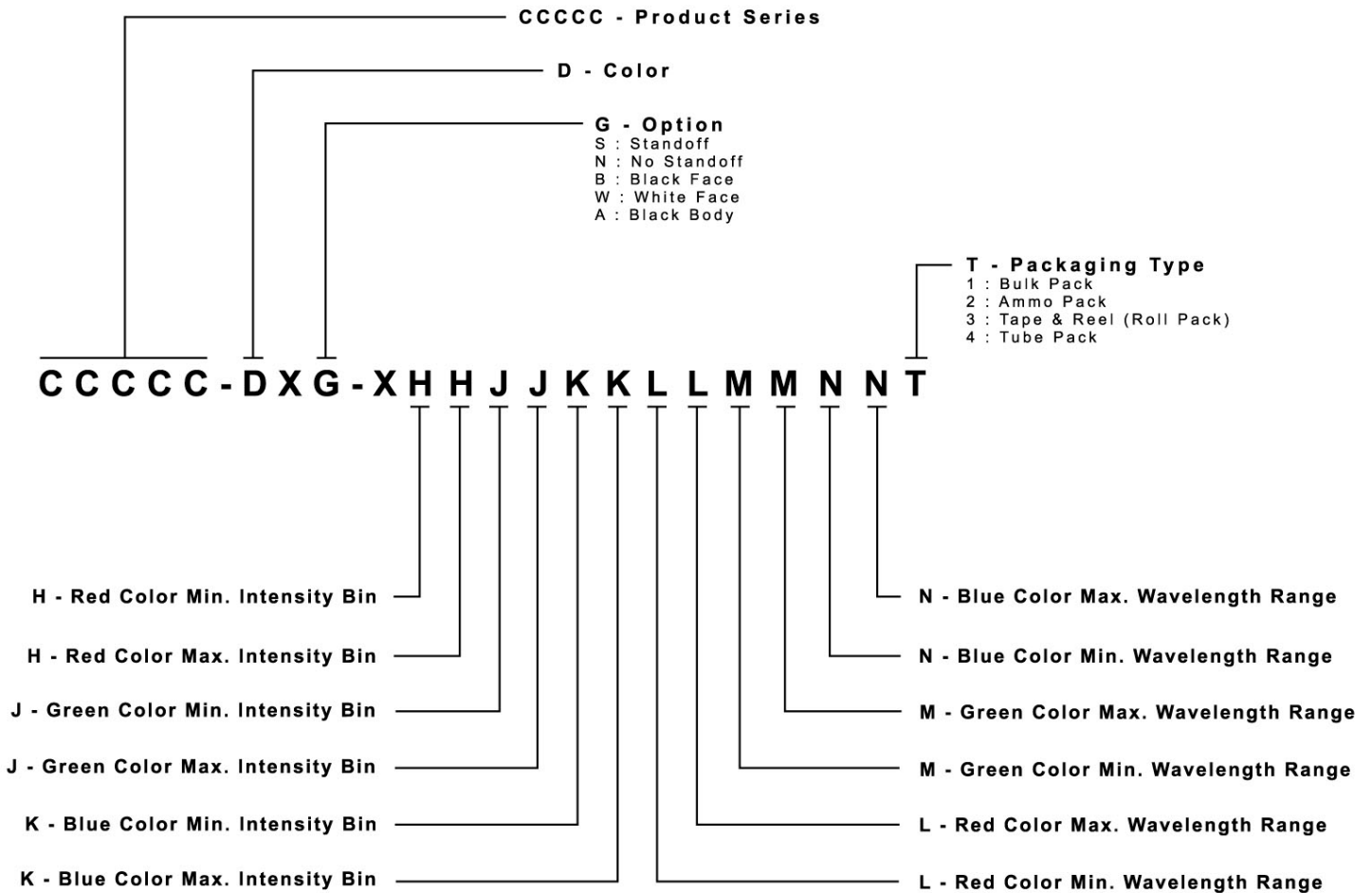

Package

- The boxes are not water-resistant, and they must be kept away from water and moisture.
- The LEDs are packed in cardboard boxes after packaging in normal or anti-electrostatic bags.
- Cardboard boxes will be used to protect the LEDs from mechanical shocks during transportation.
- The reel pack is applied in SMD LED.
- Max 2000 pcs per reel.

