

# HLMP-ED80

## Radiometrically Tested AllnGaP II LED Lamps for Sensor-Based Applications



### Data Sheet



#### Description

Radiometrically Tested Precision Optical Performance AllnGaP II (aluminum indium gallium phosphide) LEDs offer increased sensor-based application design flexibility. High-resolution radiometric intensity bins (mW/sr) enable customers to precisely match LED lamp performance with sensor functionality.

Visible LEDs offer new styling alternatives — light can be leveraged to develop more attractive products. In comparison to invisible infrared sources, safety concerns are significantly improved by the human autonomic pupil response and reflexive movement away from bright light. Visible LEDs further indicate system on/off status.

The AllnGaP II technology provides extremely stable light output over very long periods of time, with low power consumption.

These lamps are made with an advanced optical grade epoxy system offering superior high temperature and moisture resistance performance in outdoor systems. The epoxy contains both uv-a and uv-b inhibitors to reduce the effects of long term exposure to direct sunlight.

Please contact your Avago Technologies Representative for more information and design for manufacture advice. Application Brief I-024 *Pulsed Operating Ranges for AllnGaP LEDs vs. Projected Long Term Light Output Performance* and other application information is available at: [www.avago-tech.com/go/led\\_lamps](http://www.avago-tech.com/go/led_lamps).

#### Features

- Characterized by radiometric intensity
- High optical power output
- Extremely long useful life
- Low power consumption
- Well defined spatial radiation patterns
- 639 nm<sub>PEAK</sub> red color
- 30° viewing angle
- High operating temperature:  $T_{jLED} = +130^{\circ}C$
- Superior resistance to moisture
- Suitable for outdoor use

#### Applications

- Photo sensor stimulus
- Infrared emitter replacement
- Solid state optical mouse sensors
- Surface imaging sensors
- Optical position and motion sensors
- Human interface devices
- Computer printer dot quality control
- Battery powered systems

#### Benefits

- Radiometric LED characterization decreases system variability
- Improved system reliability
- Visual styling
- Visible color for improved application safety
- On/off indication
- Suitable for a variety of sensor-based applications

## Device Selection Guide

Part Number	Minimum Radiometric Intensity (mW/Sr) at 20 mA	Maximum Forward Voltage (V) at 20 mA
HLMP-ED80-KOT00	7.2	2.6
HLMP-ED80-K0000	7.2	2.4

## Package Dimensions

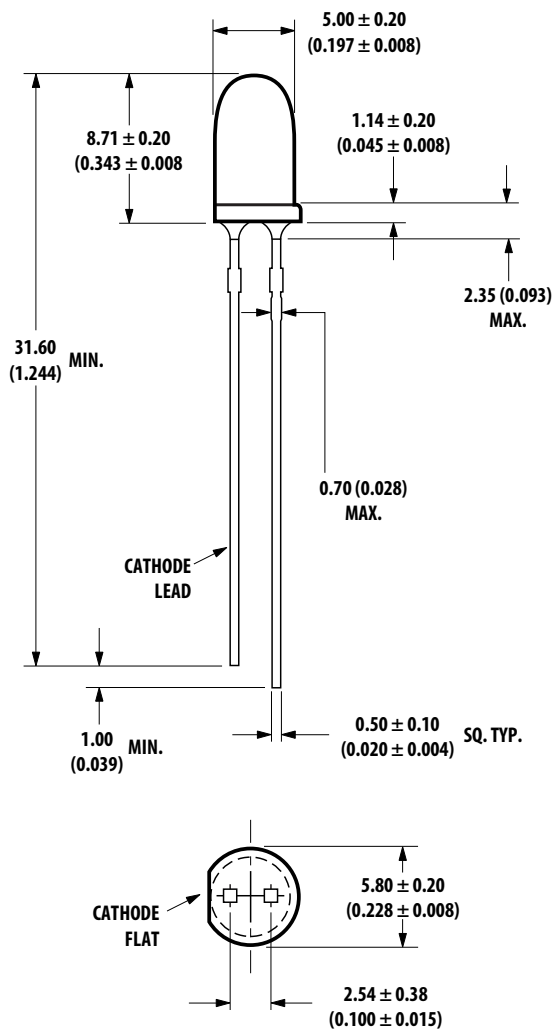

**NOTE:**  
ALL DIMENSIONS ARE IN mm (INCHES).

## Part Numbering System

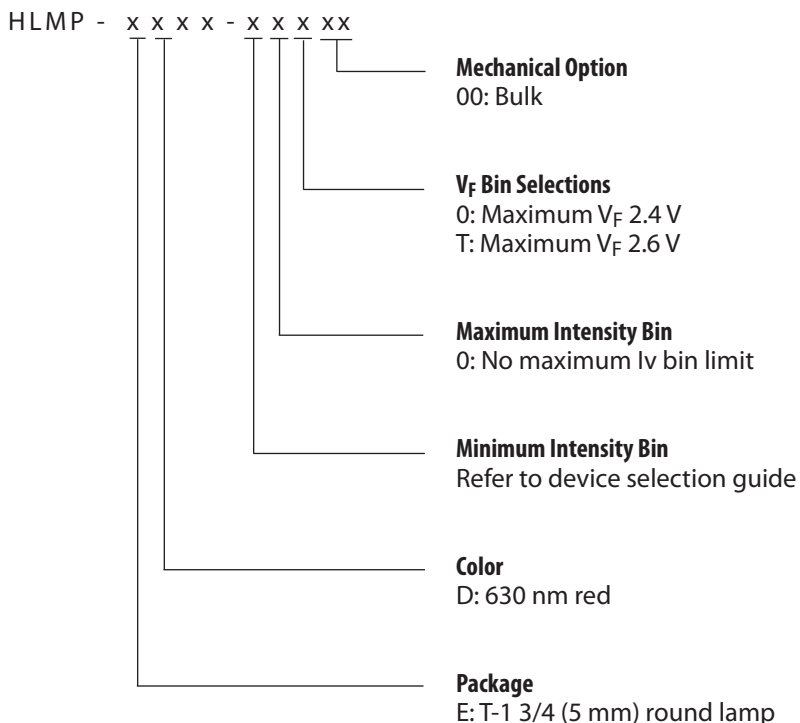

Note: Please refer to AB 5337 for complete information on part numbering system.

## Absolute Maximum Ratings at T<sub>A</sub> = 25°C

DC Forward Current <sup>[1,2,3]</sup> .....	50 mA
Peak Pulsed Forward Current <sup>[2,3]</sup> .....	100 mA
Average Forward Current .....	30 mA
Reverse Voltage (I <sub>R</sub> = 100 μA).....	5 V
LED Junction Temperature.....	130°C
Operating Temperature .....	-40°C to +100°C
Storage Temperature .....	-40°C to +100°C

### Notes:

1. Derate linearly as shown in Figure 4.
2. For long term performance with minimal light output degradation, drive currents between 10 mA and 30 mA are recommended. For more information on recommended drive conditions, please refer to HP Application Brief I-024 (5966-3087E).
3. Please contact your Avago sales representative about operating currents below 10 mA.

## Electrical/Optical Characteristics at $T_A = 25^\circ\text{C}$

Parameter	Symbol	Min.	Typ.	Max.	Units	Test Conditions
Forward Voltage						
ED80-xx0xx	$V_F$		2.00	2.40	V	$I_F = 20\text{ mA}$
ED80-xxTxx			2.35	2.60		
Reverse Voltage	$V_R$	5	20		V	$I_R = 100\ \mu\text{A}$
Peak Wavelength	$\lambda_{\text{PEAK}}$		639		nm	Peak of Wavelength of Spectral Distribution at $I_F = 20\text{ mA}$
Dominant Wavelength <sup>[1]</sup>	$\lambda_d$		630		nm	
Spectral Halfwidth	$\Delta\lambda_{1/2}$		17		nm	Wavelength Width at Spectral Distribution $1/2$ Power Point at $I_F = 20\text{ mA}$
Speed of Response	$\tau_s$		20		ns	Exponential Time Constant, $e^{-t/\tau_s}$
Capacitance	C		40		pF	$V_F = 0, f = 1\text{ MHz}$
Thermal Resistance	$R_{\Theta\text{J-PIN}}$		240		$^\circ\text{C/W}$	LED Junction-to-Cathode Lead
Luminous Efficacy <sup>[5]</sup>	$\eta_v$		155		lm/W	Emitted Luminous Power/Emitted Radiant Power at $I_F = 20\text{ mA}$
Viewing Angle <sup>[2]</sup>	$2\ \theta_{1/2}$		30		Deg.	
Radiometric Intensity <sup>[3,4]</sup>	$I_e$	7.23		50.50	mW/sr	Emitted Radiant Power at $I_F = 20\text{ mA}$

### Notes:

1. Dominant wavelength,  $\lambda_d$ , is derived from the CIE Chromaticity Diagram referenced to Illuminant E.
2.  $\theta_{1/2}$  is the off-axis angle where the luminous intensity is one half the on-axis intensity.
3. The radiometric intensity is measured on the mechanical axis of the lamp package.
4. The optical axis is closely aligned with the package mechanical axis.
5. The luminous intensity,  $I_v$ , in candelas, may be found from the equation  $I_v = I_e \eta_v$ , where  $I_e$  is the radiometric intensity in watts per steradian and  $\eta_v$  is the luminous efficacy in lumens/watt.
6. For option -xxTxx, max. forward voltage ( $V_f$ ) is 2.6 V. Refer to  $V_f$  bin table.

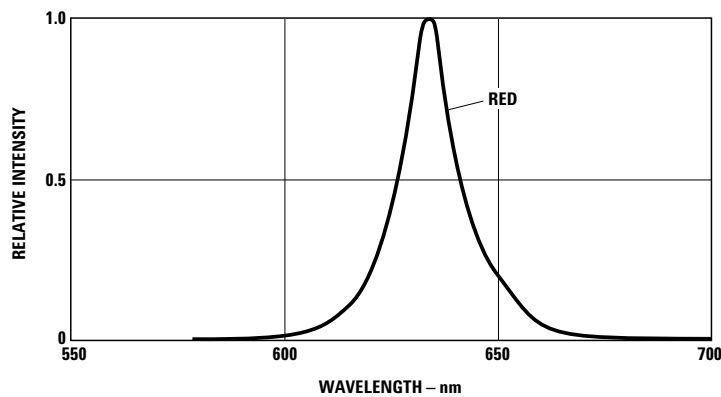

Figure 1. Relative Intensity vs. Peak Wavelength.

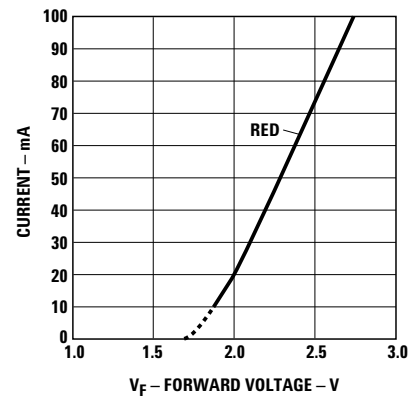

Figure 2a. Forward Current vs. Forward Voltage for Option -xx0xx.

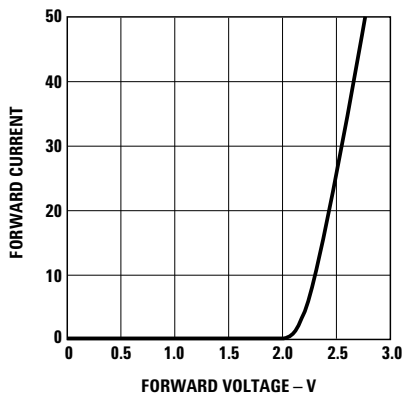

Figure 2b. Forward Current vs. Forward Voltage for Option -xxTxx.

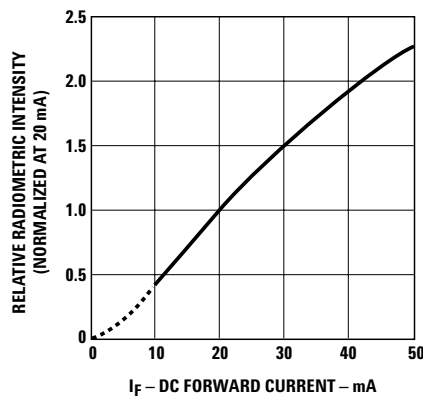

Figure 3. Relative Luminous Intensity vs. Forward Current.

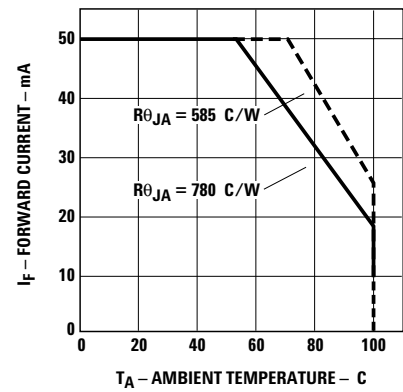

Figure 4. Maximum Forward Current vs. Ambient Temperature. Derating Based on  $T_{JMAX} = 130^{\circ}C$ .

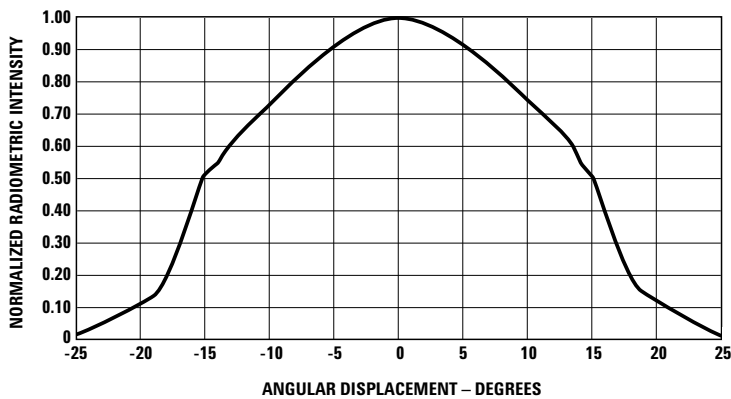

Figure 5. Representative Spatial Radiation Pattern for 30° Viewing Angle Lamps.

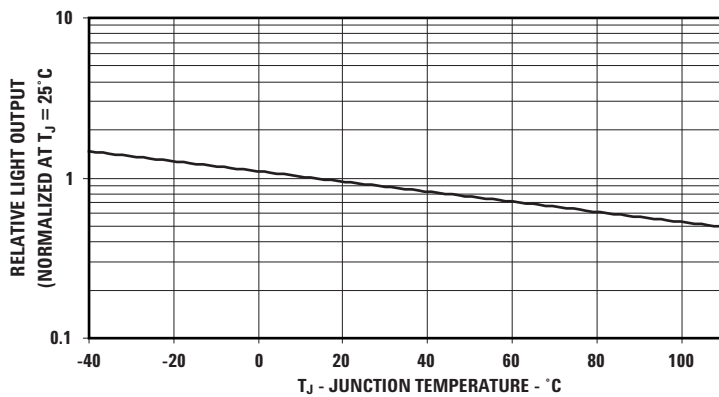

Figure 6. Relative Light Output vs Junction Temperature

### Radiometric Intensity Bin Limits (mW/sr at 20 mA)

Bin ID	Min.	Max.
K	8.5	10.2
L	10.2	12.2
M	12.2	14.7
N	14.7	17.6
P	17.6	21.2
Q	21.2	25.4
R	25.4	30.5
S	30.5	36.5
T	36.5	43.9

### Vf Bin Table<sup>[3]</sup>

Bin ID	Min.	Max.
VA	2.0	2.2
VB	2.2	2.4
VC	2.4	2.6

Tolerance for each bin limit is  $\pm 0.05$  V.

#### Notes:

1. Tolerance for each bin will be  $\pm 15\%$ .
2. Bin categories are established for classification of products. Products may not be available in all bin categories.
3. Vf bin table only available for those number with options -xxTxx.

## Precautions:

### Lead Forming:

- The leads of an LED lamp may be preformed or cut to length prior to insertion and soldering on PC board.
- For better control, it is recommended to use proper tool to precisely form and cut the leads to applicable length rather than doing it manually.
- If manual lead cutting is necessary, cut the leads after the soldering process. The solder connection forms a mechanical ground which prevents mechanical stress due to lead cutting from traveling into LED package. This is highly recommended for hand solder operation, as the excess lead length also acts as small heat sink.

### Soldering and Handling:

- Care must be taken during PCB assembly and soldering process to prevent damage to the LED component.
- LED component may be effectively hand soldered to PCB. However, it is only recommended under unavoidable circumstances such as rework. The closest manual soldering distance of the soldering heat source (soldering iron's tip) to the body is 1.59mm. Soldering the LED using soldering iron tip closer than 1.59mm might damage the LED.

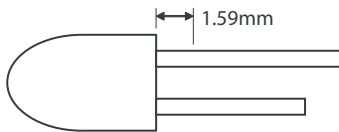

- ESD precaution must be properly applied on the soldering station and personnel to prevent ESD damage to the LED component that is ESD sensitive. Do refer to Avago application note AN 1142 for details. The soldering iron used should have grounded tip to ensure electrostatic charge is properly grounded.
- Recommended soldering condition:

	Wave Soldering [1, 2]	Manual Solder Dipping
Pre-heat temperature	105 °C Max.	-
Preheat time	60 sec Max	-
Peak temperature	250 °C Max.	260 °C Max.
Dwell time	3 sec Max.	5 sec Max

#### Note:

1. Above conditions refers to measurement with thermocouple mounted at the bottom of PCB.
  2. It is recommended to use only bottom preheaters in order to reduce thermal stress experienced by LED.
- Wave soldering parameters must be set and maintained according to the recommended temperature and dwell time. Customer is advised to perform daily check on the soldering profile to ensure that it is always conforming to recommended soldering conditions.

#### Note:

1. PCB with different size and design (component density) will have different heat mass (heat capacity). This might cause a change in temperature experienced by the board if same wave soldering setting is used. So, it is recommended to re-calibrate the soldering profile again before loading a new type of PCB.

## Avago Technologies LED configuration

Note: Electrical connection between bottom surface of LED die and the lead frame is achieved through conductive paste.

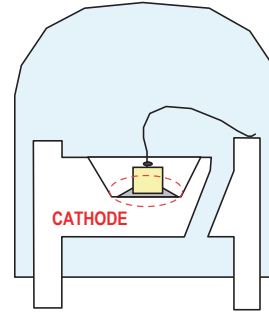

AllnGaP Device

- Any alignment fixture that is being applied during wave soldering should be loosely fitted and should not apply weight or force on LED. Non metal material is recommended as it will absorb less heat during wave soldering process.
- At elevated temperature, LED is more susceptible to mechanical stress. Therefore, PCB must allowed to cool down to room temperature prior to handling, which includes removal of alignment fixture or pallet.
- If PCB board contains both through hole (TH) LED and other surface mount components, it is recommended that surface mount components be soldered on the top side of the PCB. If surface mount need to be on the bottom side, these components should be soldered using reflow soldering prior to insertion the TH LED.
- Recommended PC board plated through holes (PTH) size for LED component leads.

LED component lead size	Diagonal	Plated through hole diameter
0.45 x 0.45 mm (0.018x 0.018 inch)	0.636 mm (0.025 inch)	0.98 to 1.08 mm (0.039 to 0.043 inch)
0.50 x 0.50 mm (0.020x 0.020 inch)	0.707 mm (0.028 inch)	1.05 to 1.15 mm (0.041 to 0.045 inch)

- Over-sizing the PTH can lead to twisted LED after clinching. On the other hand under sizing the PTH can cause difficulty inserting the TH LED.

Refer to Application Note 5334 for more information about soldering and handling of high brightness TH LED lamps.

### Example of Wave Soldering Temperature Profile for TH LED

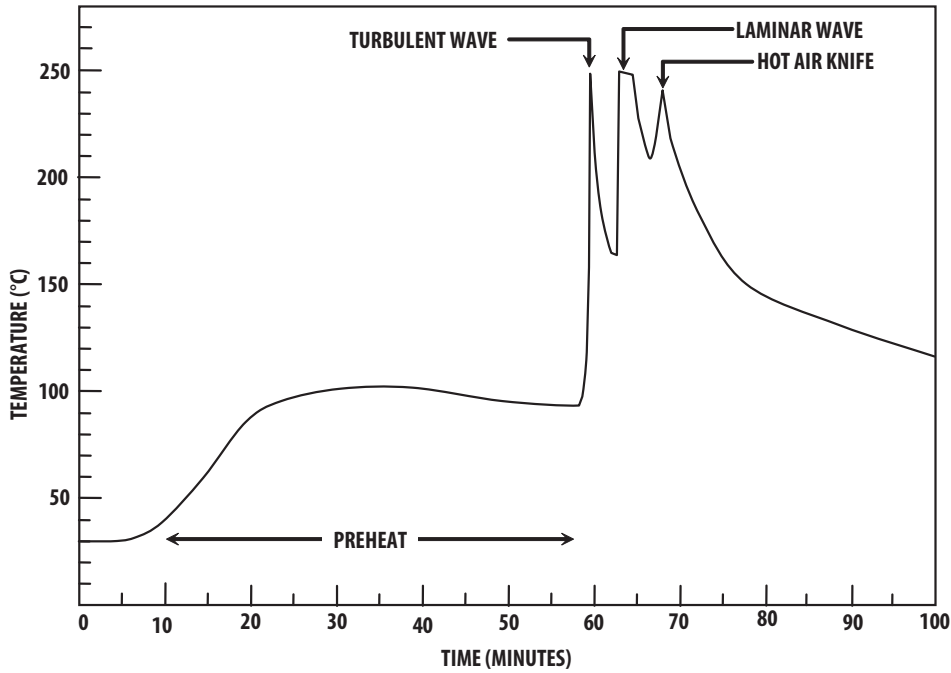

Recommended solder:  
 Sn63 (Leaded solder alloy)  
 SAC305 (Lead free solder alloy)

Flux: Rosin flux

Solder bath temperature:  
 245°C ± 5°C (maximum peak  
 temperature = 250°C)

Dwell time: 1.5 sec - 3.0 sec  
 (maximum = 3sec)

Note: Allow for board to be  
 sufficiently cooled to room  
 temperature before exerting  
 mechanical force.

### Ammo Packs Drawing

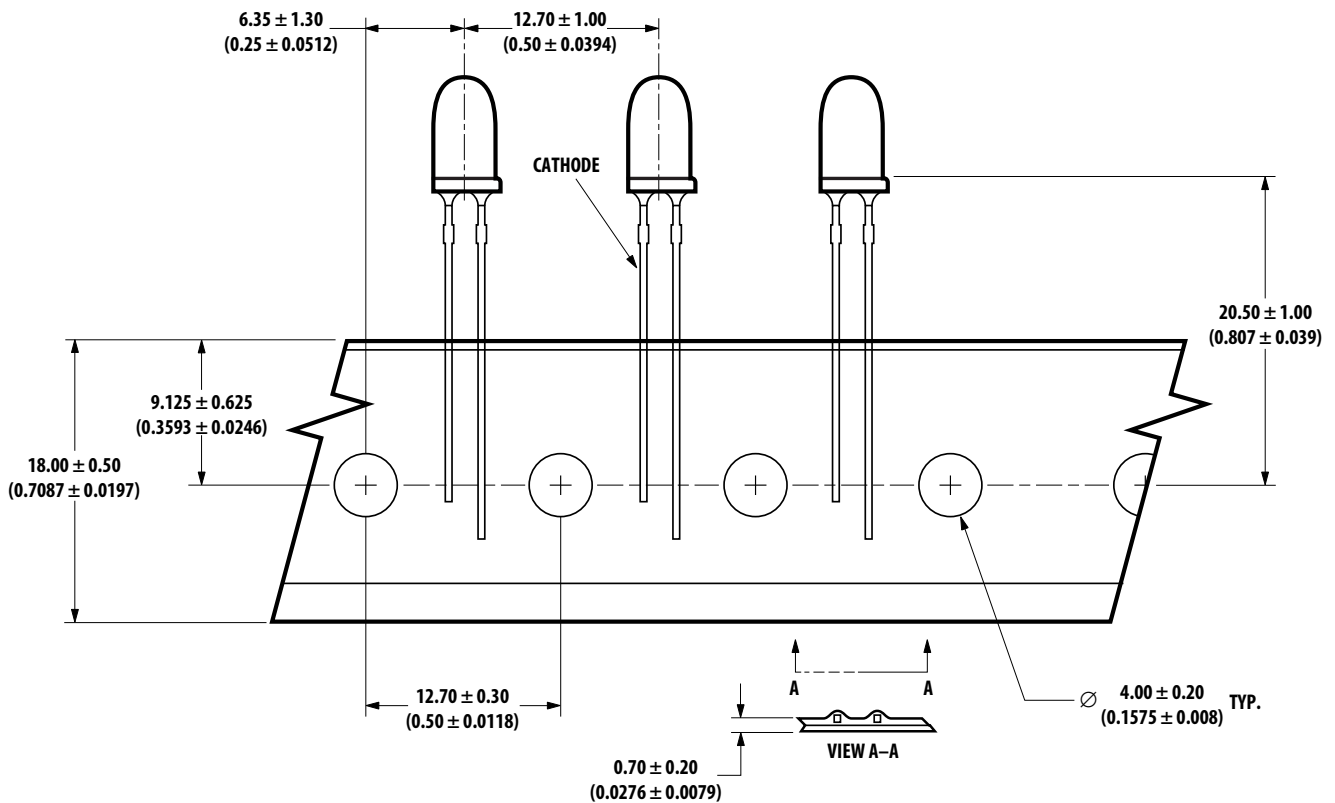

ALL DIMENSIONS IN MILLIMETERS (INCHES).

NOTE: THE AMMO-PACKS DRAWING IS APPLICABLE FOR PACKAGING OPTION -DD & -ZZ AND REGARDLESS OF STANDOFF OR NON-STANDOFF.

## Packaging Box for Ammo Packs

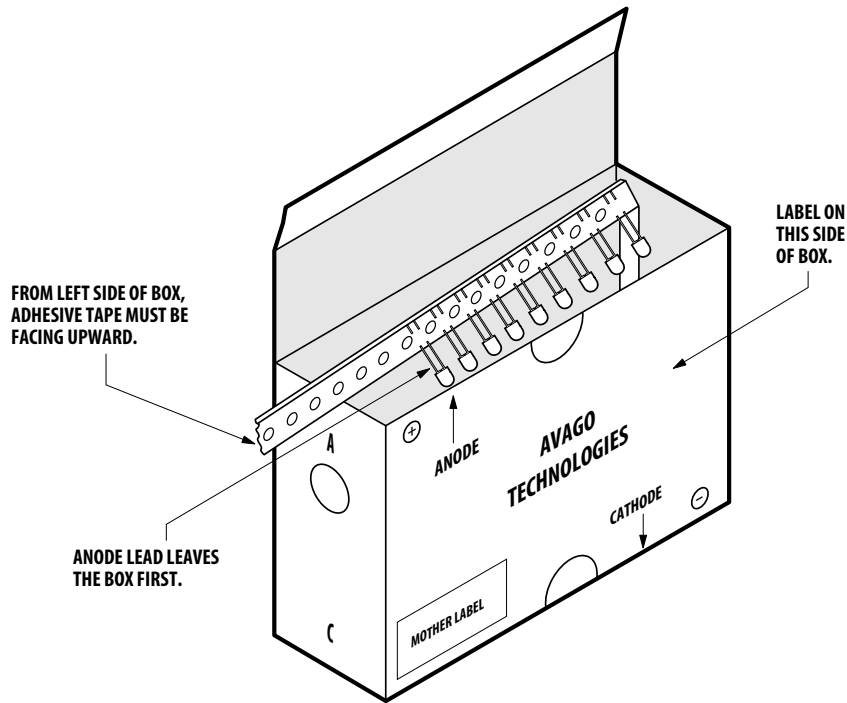

**NOTE:**  
THE DIMENSION FOR AMMO PACK IS APPLICABLE FOR THE DEVICE WITH STANDOFF AND WITHOUT STANDOFF.

## Packaging Label

(i) Avago Mother Label: (Available on packaging box of ammo pack and shipping box)

<b>AVAGO</b> TECHNOLOGIES	
(1P) Item: <b>Part Number</b> [Barcode]	STANDARD LABEL LS0002 RoHS Compliant e3 max temp 250C
(1T) Lot: <b>Lot Number</b> [Barcode]	(Q) QTY: <b>Quantity</b> [Barcode]
LPN: [Barcode]	CAT: <b>Intensity Bin</b> [Barcode]
(9D)MFG Date: <b>Manufacturing Date</b> [Barcode]	BIN: <b>Refer to below information</b>
<hr/>	
(P) Customer Item: [Barcode]	(9D) Date Code: <b>Date Code</b> [Barcode]
(V) Vendor ID: [Barcode]	Made In: <b>Country of Origin</b> [Barcode]
DeptID: [Barcode]	



(ii) Avago Baby Label (Only available on bulk packaging)

 <b>Lamps Baby Label</b>		RoHS Compliant e3 max temp 250C
(1P) PART #: Part Number 		
(1T) LOT #: Lot Number 		
(9D)MFG DATE: Manufacturing Date 	QUANTITY: Packing Quantity 	
C/O: Country of Origin		
Customer P/N: 	CAT: Intensity Bin 	
Supplier Code: 	BIN: Refer to below information 	
	DATECODE: Date Code 	

**Acronyms and Definition:**

**BIN:**

- (i) Color bin only or VF bin only  
(Applicable for part number with color bins but without VF bin OR part number with VF bins and no color bin)  
OR
- (ii) Color bin incorporated with VF Bin  
(Applicable for part number that have both color bin and VF bin)

**Example:**

- (i) Color bin only or VF bin only  
BIN: 2 (represent color bin 2 only)  
BIN: VB (represent VF bin "VB" only)
- (ii) Color bin incorporate with VF Bin  
BIN: 2VB

*DISCLAIMER: AVAGO'S PRODUCTS AND SOFTWARE ARE NOT SPECIFICALLY DESIGNED, MANUFACTURED OR AUTHORIZED FOR SALE AS PARTS, COMPONENTS OR ASSEMBLIES FOR THE PLANNING, CONSTRUCTION, MAINTENANCE OR DIRECT OPERATION OF A NUCLEAR FACILITY OR FOR USE IN MEDICAL DEVICES OR APPLICATIONS. CUSTOMER IS SOLELY RESPONSIBLE, AND WAIVES ALL RIGHTS TO MAKE CLAIMS AGAINST AVAGO OR ITS SUPPLIERS, FOR ALL LOSS, DAMAGE, EXPENSE OR LIABILITY IN CONNECTION WITH SUCH USE.*

For product information and a complete list of distributors, please go to our website: [www.avagotech.com](http://www.avagotech.com)

Avago, Avago Technologies, and the A logo are trademarks of Avago Technologies in the United States and other countries. Data subject to change. Copyright © 2005-2009 Avago Technologies. All rights reserved. Obsoletes 5989-4366EN AV02-1523EN - January 20, 2009

