

# HLMP-AG62/AG63, AH62/AH63, AL62/AL63 HLMP-HG62/HG63, HH62/HH63, HL62/HL63 5mm Mini Oval and Standard Oval AllnGaP LEDs



## Data Sheet



Lead (Pb) Free  
RoHS 6 fully  
compliant



### Description

These Precision Optical Performance AllnGaP Oval LEDs are specifically designed for full color/video and passenger information signs. The oval shaped radiation pattern and high luminous intensity ensure that these devices are excellent for wide field of view outdoor applications where a wide viewing angle and readability in sunlight are essential. The package epoxy contains both UV-A and UV-B inhibitors to reduce the effects of long term exposure to direct sunlight.

### Applications

- Full color signs

### Features

- Viewing Angle: 30°x70° and 40°x100°
- Colors:
  - 590nm Amber
  - 615nm Red-Orange
  - 626nm Red
- Well defined spatial radiation pattern
- High brightness material
- Superior resistance to moisture
- Package options:
  - Stand-off and Non Stand-off Leads
- Tinted and diffused

## Package Dimensions

For 5mm Mini Oval 30°x70°  
Package Drawing A

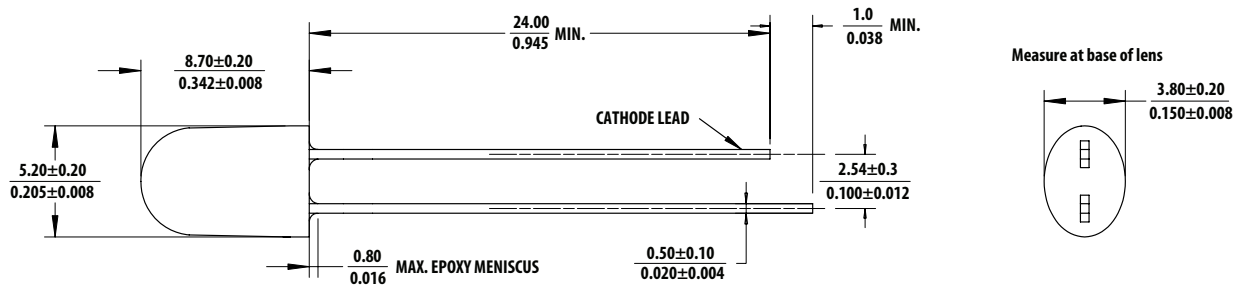

## Package Drawing B

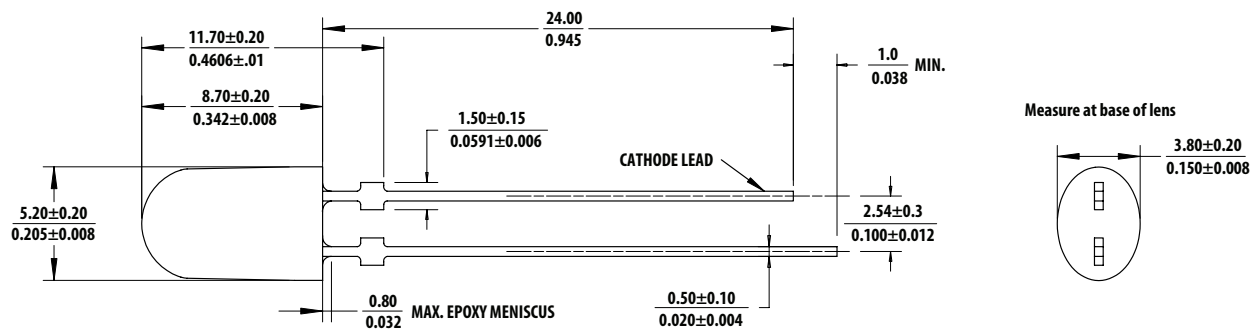

For 5mm Standard Oval 40°x100°  
Package Drawing C

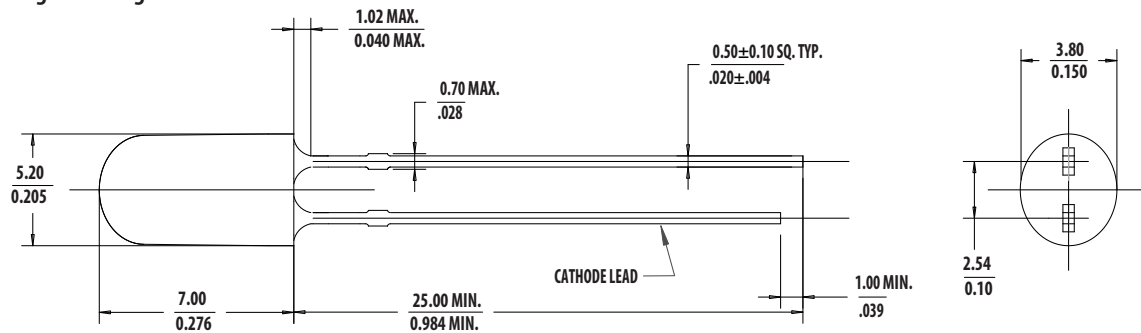

## Package Drawing D

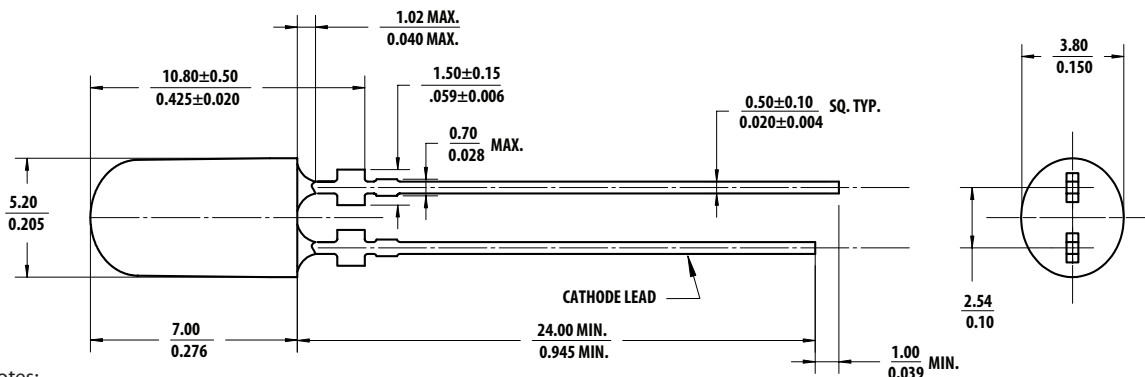

### Notes:

All dimensions in millimeters (inches).

Tolerance is  $\pm 0.20$ mm unless otherwise specified.

## Device Selection Guide

### 5mm Mini Oval 30°x70°

Part Number	Color and Dominant Wavelength $\lambda_d$ (nm) Typ.	Luminous Intensity Iv (mcd) at 20 mA Min.	Luminous Intensity Iv (mcd) at 20 mA Max.	Stand-Off	Package Drawing
HLMP-AL62-UX0DD	Amber 590	960	1990	No	A
HLMP-AL62-X10DD	Amber 590	1660	3500	No	A
HLMP-AH62-UX0DD	Red-Orange 615	960	1990	No	A
HLMP-AH62-X10DD	Red-Orange 615	1660	3500	No	A
HLMP-AG62-UX0DD	Red 626	960	1990	No	A
HLMP-AG62-X10DD	Red 626	1660	3500	No	A
HLMP-AL63-UX0DD	Amber 590	960	1990	Yes	B
HLMP-AL63-X10DD	Amber 590	1660	3500	Yes	B
HLMP-AH63-UX0DD	Red-Orange 615	960	1990	Yes	B
HLMP-AH63-X10DD	Red-Orange 615	1660	3500	Yes	B
HLMP-AG63-UX0DD	Red 626	960	1990	Yes	B
HLMP-AG63-X10DD	Red 626	1660	3500	Yes	B

### 5mm Standard Oval 40°x100°

Part Number	Color and Dominant Wavelength $\lambda_d$ (nm) Typ.	Luminous Intensity Iv (mcd) at 20 mA Min.	Luminous Intensity Iv (mcd) at 20 mA Max.	Stand-Off	Package Drawing
HLMP-HL62-TX0DD	Amber 590	800	1990	No	C
HLMP-HH62-TX0DD	Red-Orange 615	800	1990	No	C
HLMP-HG62-TX0DD	Red 626	800	1990	No	C
HLMP-HL63-TX0DD	Amber 590	800	1990	Yes	D
HLMP-HH63-TX0DD	Red-Orange 615	800	1990	Yes	D
HLMP-HG63-TX0DD	Red 626	800	1990	Yes	D

Notes:

1. The luminous intensity is measured on the mechanical axis of the lamp package.
2. Tolerance for each intensity limit is  $\pm 15\%$ .
3. Please refer to AN 5352 for detail information on features of stand-off and non stand-off LEDs.

## Part Numbering System

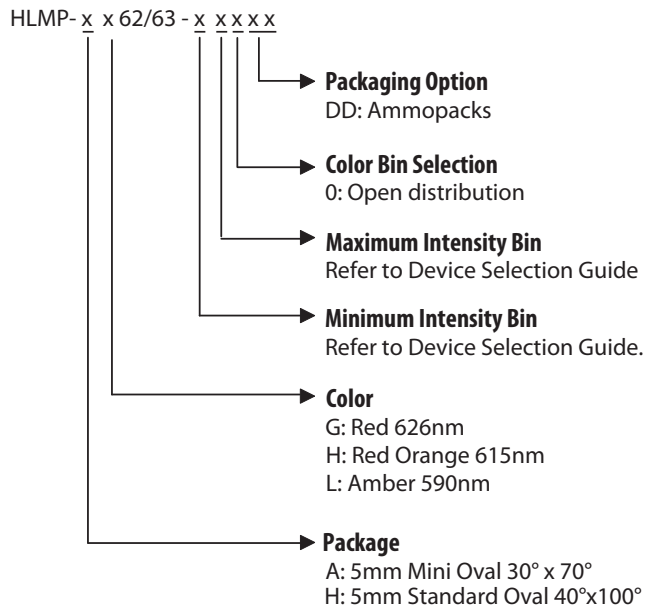

Note: Please refer to AB 5337 for complete information on part numbering system.

## Absolute Maximum Ratings

$T_A = 25^\circ\text{C}$

Parameter	Value	Unit
DC Forward Current <sup>[1]</sup>	50	mA
Peak Forward Current	100 <sup>[2]</sup>	mA
Power Dissipation	120	mW
Reverse Voltage	5 (IR = 100 $\mu\text{A}$ )	V
LED Junction Temperature	130	$^\circ\text{C}$
Operating Temperature Range	-40 to +100	$^\circ\text{C}$
Storage Temperature Range	-40 to +100	$^\circ\text{C}$

Notes:

1. Derate linearly as shown in Figure 4.
2. Duty Factor 30%, frequency 1kHz.

## Electrical / Optical Characteristics

$T_A = 25^\circ\text{C}$

Parameter	Symbol	Min.	Typ.	Max.	Units	Test Conditions
Forward Voltage						
Amber			2.2			
Red	$V_F$	1.8	2.1	2.4	V	$I_F = 20\text{ mA}$
Red-Orange			2.0			
Reverse Voltage	$V_R$	5			V	$I_R = 100\ \mu\text{A}$
Dominant Wavelength <sup>[1]</sup>						
Amber		584.5		594.5		
Red	$\lambda_d$	620		630	nm	$I_F = 20\text{ mA}$
Red-Orange		612		621.7		
Peak Wavelength						
Amber			590			
Red	$\lambda_{PEAK}$		626		nm	Peak of Wavelength of Spectral Distribution at $I_F = 20\text{ mA}$
Red-Orange			615			
Thermal Resistance	$R\theta_{J-PIN}$		240		$^\circ\text{C/W}$	LED Junction-to-Anode Lead
Luminous Efficacy <sup>[2]</sup>						
Amber			480			
Red	$\eta_V$		150		lm/W	Emitted Luminous Power/Emitted Radiant Power
Red-Orange			260			

Notes:

1. The dominant wavelength is derived from the chromaticity Diagram and represents the color of the lamp. Tolerance for each color of dominant wavelength is  $\pm 0.5\text{nm}$ .
2. The radiant intensity,  $I_e$  in watts per steradian, may be found from the equation  $I_e = I_V/\eta_V$  where  $I_V$  is the luminous intensity in candelas and  $\eta_V$  is the luminous efficacy in lumens/watt.

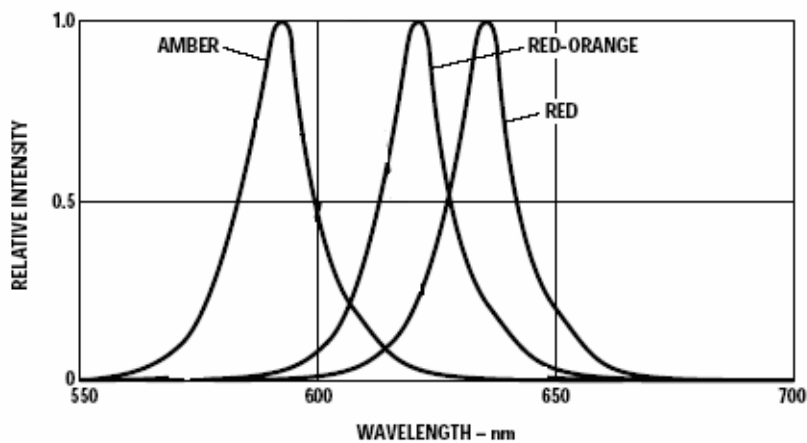

Figure 1. Relative intensity vs. peak wavelength

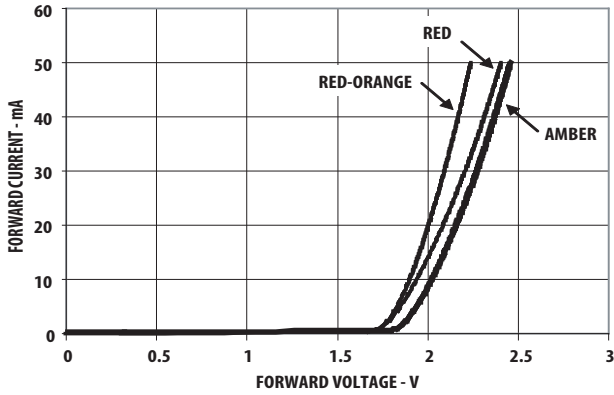

Figure 2. Forward current vs. forward voltage

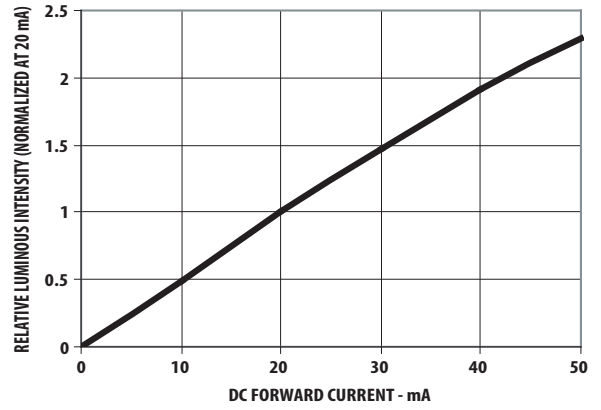

Figure 3. Relative luminous intensity vs. forward current

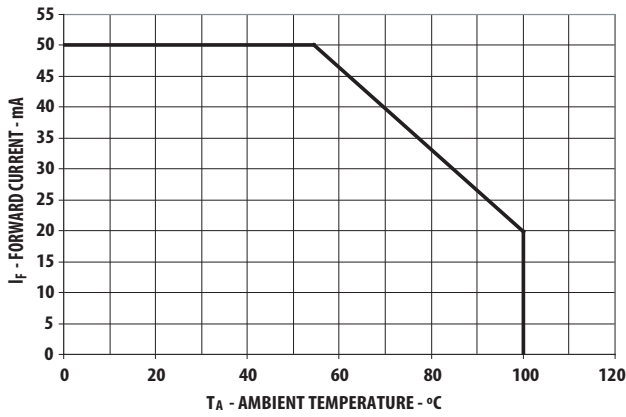

Figure 4. Maximum forward current vs. ambient temperature

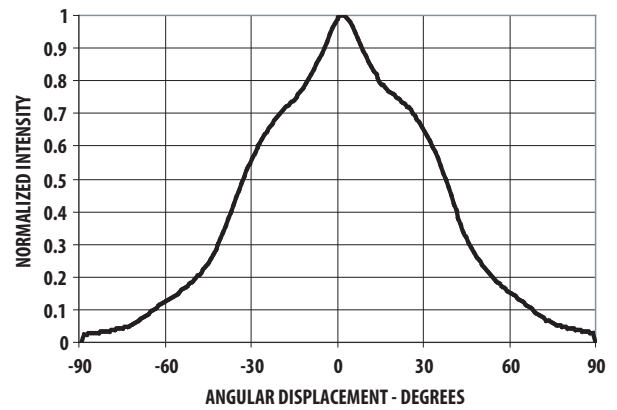

Figure 5. Representative Radiation pattern for 30°x70° Lamp -Major Axis

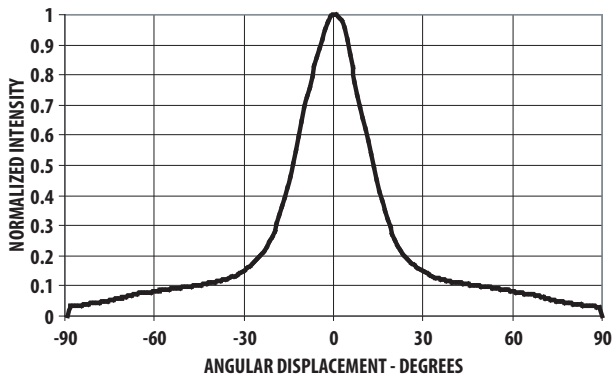

Figure 6. Representative Radiation pattern 30°x70° Lamp -Minor Axis

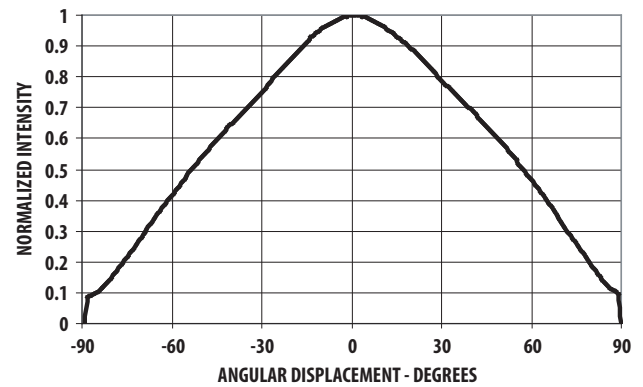

Figure 7. Representative Radiation pattern for 40°x100° Lamp -Major Axis

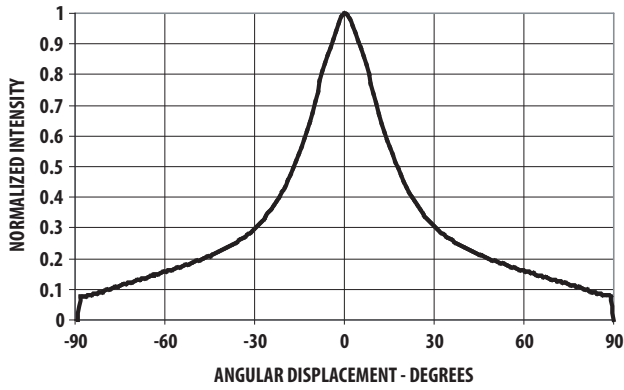

Figure 8. Representative Radiation pattern 40°x100° Lamp –Minor Axis

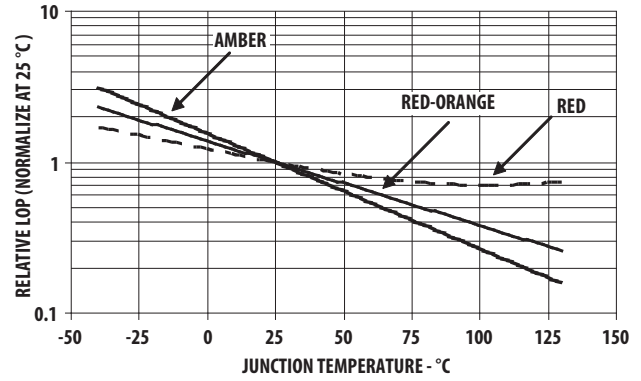

Figure 9. Relative Light Output vs Junction temperature

#### Intensity Bin Limit Table (1.2: 1 Iv Bin Ratio)

Bin	Intensity (mcd) at 20 mA	
	Min	Max
U	960	1150
V	1150	1380
W	1380	1660
X	1660	1990
Y	1990	2400
Z	2400	2900
1	2900	3500

Tolerance for each bin limit is  $\pm 15\%$

#### Vf Bin Table (V at 20mA)

Bin ID	Min	Max
VD	1.8	2.0
VA	2.0	2.2
VB	2.2	2.4

Tolerance for each bin limit is  $\pm 0.05V$

#### Amber Color Bin Limits

Bin	Min	Max
1	584.5	587.0
2	587.0	589.5
4	589.5	592.0
6	592.0	594.5

Tolerance for each bin limit is  $\pm 0.5nm$ .

**Precautions:**

**Lead Forming:**

- The leads of an LED lamp may be preformed or cut to length prior to insertion and soldering on PC board.
- For better control, it is recommended to use proper tool to precisely form and cut the leads to applicable length rather than doing it manually.
- If manual lead cutting is necessary, cut the leads after the soldering process. The solder connection forms a mechanical ground which prevents mechanical stress due to lead cutting from traveling into LED package. This is highly recommended for hand solder operation, as the excess lead length also acts as small heat sink.

**Soldering and Handling:**

- Care must be taken during PCB assembly and soldering process to prevent damage to the LED component.
- LED component may be effectively hand soldered to PCB. However, it is only recommended under unavoidable circumstances such as rework. The closest manual soldering distance of the soldering heat source (soldering iron's tip) to the body is 1.59mm. Soldering the LED using soldering iron tip closer than 1.59mm might damage the LED.

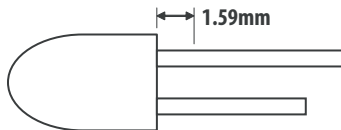

- ESD precaution must be properly applied on the soldering station and personnel to prevent ESD damage to the LED component that is ESD sensitive. Do refer to Avago application note AN 1142 for details. The soldering iron used should have grounded tip to ensure electrostatic charge is properly grounded.
- Recommended soldering condition:

	<b>Wave Soldering</b> [1, 2]	<b>Manual Solder Dipping</b>
Pre-heat temperature	105 °C Max.	-
Preheat time	60 sec Max	-
Peak temperature	250 °C Max.	260 °C Max.
Dwell time	3 sec Max.	5 sec Max

**Note:**

1. Above conditions refers to measurement with thermocouple mounted at the bottom of PCB.
  2. It is recommended to use only bottom preheaters in order to reduce thermal stress experienced by LED.
- Wave soldering parameters must be set and maintained according to the recommended temperature and dwell time. Customer is advised to perform daily check on the soldering profile to ensure that it is always conforming to recommended soldering conditions.

**Note:**

1. PCB with different size and design (component density) will have different heat mass (heat capacity). This might cause a change in temperature experienced by the board if same wave soldering setting is used. So, it is recommended to re-calibrate the soldering profile again before loading a new type of PCB.
2. Avago Technologies' high brightness LED are using high efficiency LED die with single wire bond as shown below. Customer is advised to take extra precaution during wave soldering to ensure that the maximum wave temperature does not exceed 250°C and the solder contact time does not exceeding 3sec. Over-stressing the LED during soldering process might cause premature failure to the LED due to delamination.

**Avago Technologies LED configuration**

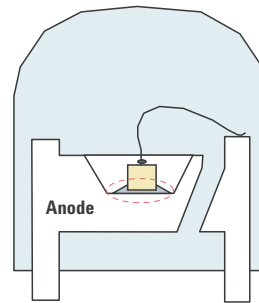

Note: Electrical connection between bottom surface of LED die and the lead frame is achieved through conductive paste.

- Any alignment fixture that is being applied during wave soldering should be loosely fitted and should not apply weight or force on LED. Non metal material is recommended as it will absorb less heat during wave soldering process.

Note: In order to further assist customer in designing jig accurately that fit Avago Technologies' product, 3D model of the product is available upon request.

- At elevated temperature, LED is more susceptible to mechanical stress. Therefore, PCB must allowed to cool down to room temperature prior to handling, which includes removal of alignment fixture or pallet.
- If PCB board contains both through hole (TH) LED and other surface mount components, it is recommended that surface mount components be soldered on the top side of the PCB. If surface mount need to be on the bottom side, these components should be soldered using reflow soldering prior to insertion the TH LED.
- Recommended PC board plated through holes (PTH) size for LED component leads.

<b>LED component lead size</b>	<b>Diagonal</b>	<b>Plated through hole diameter</b>
0.45 x 0.45 mm (0.018x 0.018 inch)	0.636 mm (0.025 inch)	0.98 to 1.08 mm (0.039 to 0.043 inch)
0.50 x 0.50 mm (0.020x 0.020 inch)	0.707 mm (0.028 inch)	1.05 to 1.15 mm (0.041 to 0.045 inch)

- Over-sizing the PTH can lead to twisted LED after clinching. On the other hand under sizing the PTH can cause difficulty inserting the TH LED



### Example of Wave Soldering Temperature Profile for TH LED

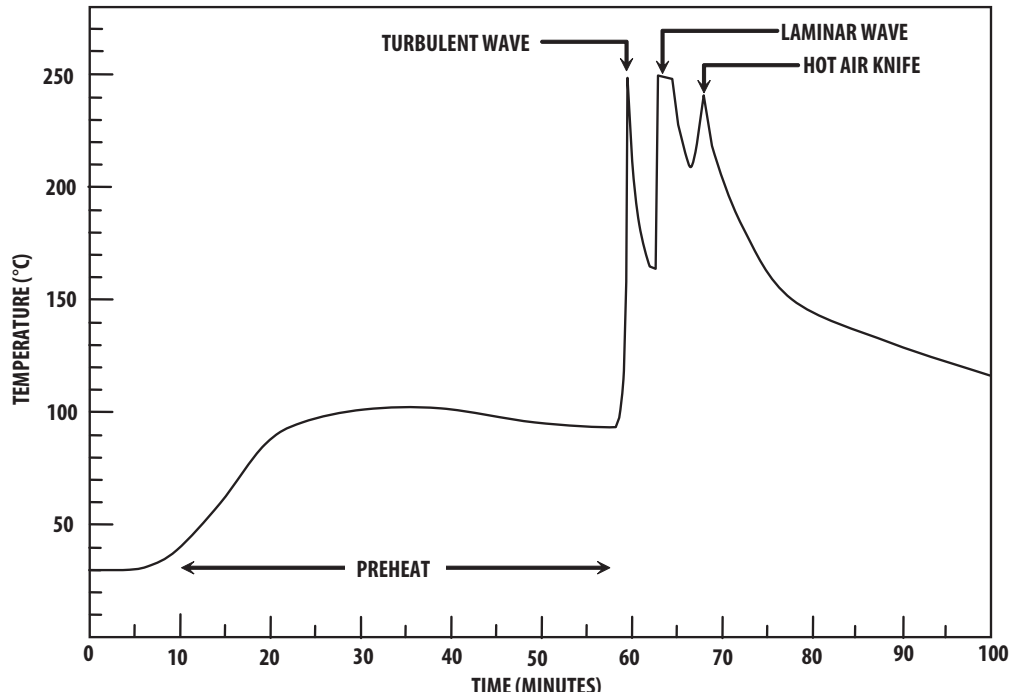

Recommended solder:  
 Sn63 (Leaded solder alloy)  
 SAC305 (Lead free solder alloy)

Flux: Rosin flux

Solder bath temperature:  
 245°C ± 5°C (maximum peak  
 temperature = 250°C)

Dwell time: 1.5 sec - 3.0 sec  
 (maximum = 3sec)

Note: Allow for board to be  
 sufficiently cooled to room  
 temperature before exerting  
 mechanical force.

### Ammo Packs Drawing

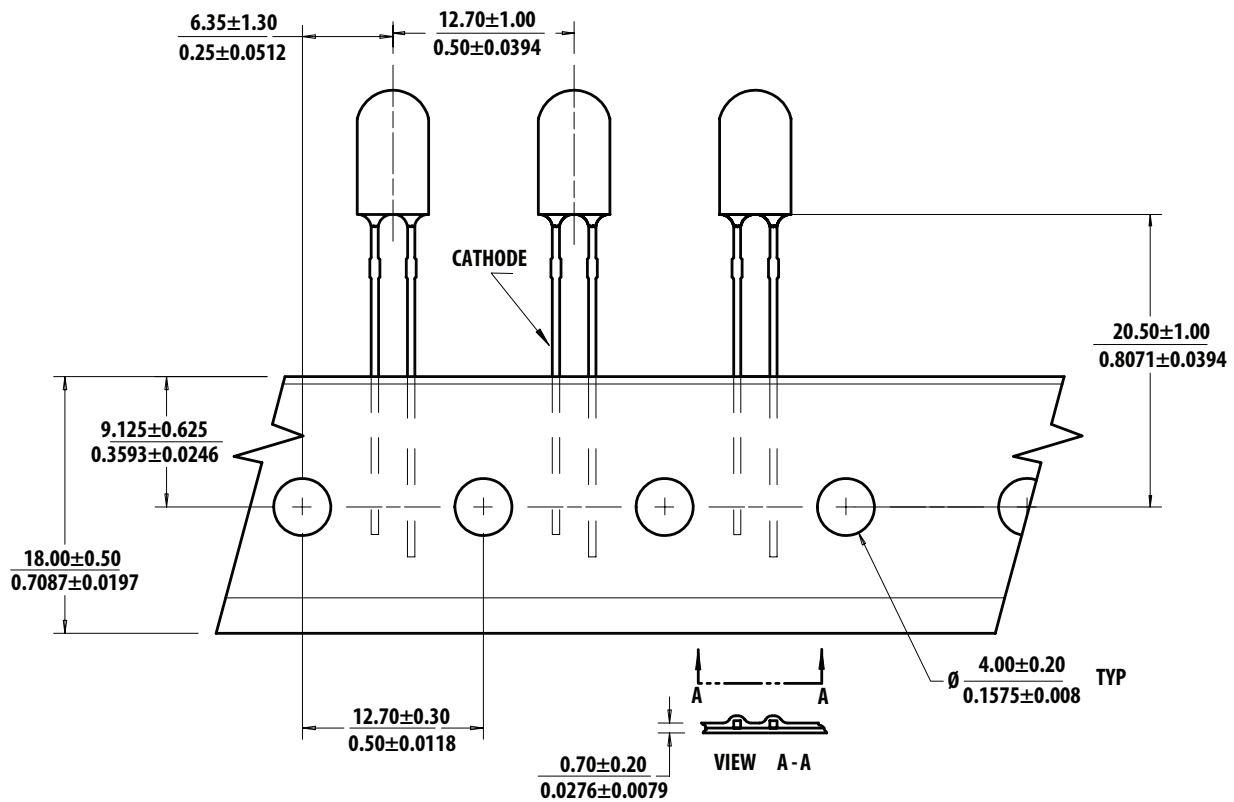

## Packaging Box for Ammo Packs

FROM LEFT SIDE OF BOX  
ADHESIVE TAPE MUST BE  
FACING UPWARDS.

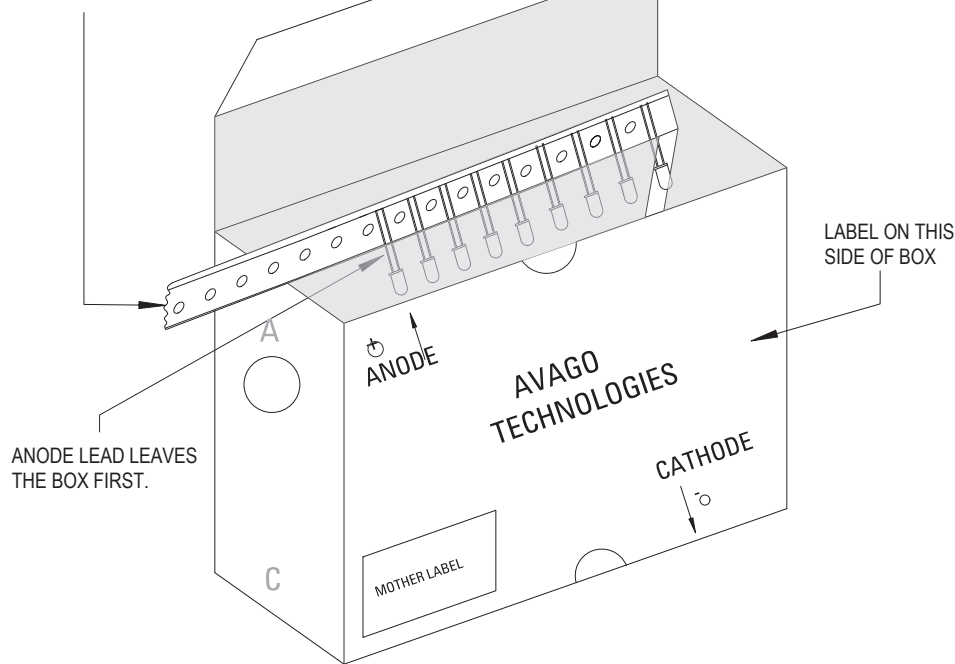











Note: For InGaN device, the ammo pack packaging box contain ESD logo

## Packaging Label

(i) Avago Mother Label: (Available on packaging box of ammo pack and shipping box)

<b>AVAGO</b> TECHNOLOGIES	
STANDARD LABEL LS0002	
RoHS Compliant	
e3 max temp 250C	
(1P) Item: <b>Part Number</b>	(Q) QTY: <b>Quantity</b>
(1T) Lot: <b>Lot Number</b>	CAT: <b>Intensity Bin</b>
LPN:	BIN: <b>Refer to below information</b>
(9D)MFG Date: <b>Manufacturing Date</b>	
<hr/>	
(P) Customer Item:	(9D) Date Code: <b>Date Code</b>
(V) Vendor ID:	Made In: <b>Country of Origin</b>
DeptID:	

(ii) Avago Baby Label (Only available on bulk packaging)

		RoHS Compliant e3 max temp 250C	
<b>Lamps Baby Label</b>			
(1P) PART #: Part Number			
			
(1T) LOT #: Lot Number			
			
(9D)MFG DATE: Manufacturing Date		QUANTITY: Packing Quantity	
			
C/O: Country of Origin			
Customer P/N:		CAT: Intensity Bin	
			
Supplier Code:		BIN: Refer to below information	
			
		DATECODE: Date Code	
			

**Acronyms and Definition:**

BIN:

(i) Color bin only or VF bin only

(Applicable for part number with color bins but without VF bin OR part number with VF bins and no color bin)

OR

(ii) Color bin incorporated with VF Bin

(Applicable for part number that have both color bin and VF bin)

**Example:**

(i) Color bin only or VF bin only

BIN: 2 (represent color bin 2 only)

BIN: VB (represent VF bin "VB" only)

(ii) Color bin incorporate with VF Bin

BIN: 2VB

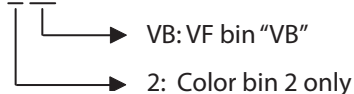

**DISCLAIMER:** AVAGO'S PRODUCTS AND SOFTWARE ARE NOT SPECIFICALLY DESIGNED, MANUFACTURED OR AUTHORIZED FOR SALE AS PARTS, COMPONENTS OR ASSEMBLIES FOR THE PLANNING, CONSTRUCTION, MAINTENANCE OR DIRECT OPERATION OF A NUCLEAR FACILITY OR FOR USE IN MEDICAL DEVICES OR APPLICATIONS. CUSTOMER IS SOLELY RESPONSIBLE, AND WAIVES ALL RIGHTS TO MAKE CLAIMS AGAINST AVAGO OR ITS SUPPLIERS, FOR ALL LOSS, DAMAGE, EXPENSE OR LIABILITY IN CONNECTION WITH SUCH USE.

For product information and a complete list of distributors, please go to our web site: [www.avagotech.com](http://www.avagotech.com)

Avago, Avago Technologies, and the A logo are trademarks of Avago Technologies in the United States and other countries. Data subject to change. Copyright © 2005-2009 Avago Technologies. All rights reserved. AV02-1314EN - January 20, 2009

