

# Cree® PLCC2 1 in 1 SMD LED

## CLM1C-WKW

### Data Sheet

SMD LEDs is packaged in the industry standard package. These LEDs have high reliability performance and are designed to work under a wide range of environmental conditions. This high reliability feature makes them ideally suited to be used under illumination application conditions.

Its wide viewing angle makes these LEDs ideally suited for channel letter, or general backlighting and illumination applications. The flat top emitting surface makes it easy for these LEDs to mate with light pipes.



#### FEATURES

- Size (mm): 3.2 x 2.7
- Color Temperatures (K):  
Cool White : Min. (4600) / Typical (6800)
- Luminous Intensity (mcd)  
Cool White (710-2240)
- Viewing Angle: 120 degree
- Lead-Free
- RoHS Compliant

#### APPLICATIONS

- Light Strip
- Channel Letter
- Backlight



## Absolute Maximum Ratings ( $T_A = 25^\circ\text{C}$ )

| Items                                | Symbol     | Absolute Maximum Rating | Unit                      |
|--------------------------------------|------------|-------------------------|---------------------------|
| Forward Current                      | $I_F$      | 25                      | mA                        |
| Peak Forward Current <sup>Note</sup> | $I_{FP}$   | 100                     | mA                        |
| Reverse Voltage                      | $V_R$      | 5                       | V                         |
| Power Dissipation                    | $P_D$      | 100                     | mW                        |
| Operation Temperature                | $T_{opr}$  | -40 ~ +100              | $^\circ\text{C}$          |
| Storage Temperature                  | $T_{stg}$  | -40 ~ +100              | $^\circ\text{C}$          |
| Junction Temperature                 | $T_J$      | 110                     | $^\circ\text{C}$          |
| Junction/Ambient                     | $R_{THJA}$ | 450                     | $^\circ\text{C}/\text{W}$ |
| Junction/Solder Point                | $R_{THJS}$ | 300                     | $^\circ\text{C}/\text{W}$ |

**Note:** Pulse width  $\leq 0.1$  msec, duty cycle  $\leq 1/10$ .

## Typical Electrical & Optical Characteristics ( $T_A = 25^\circ\text{C}$ )

| Characteristics          | Symbol          | Condition     | Unit          | Minimum | Typical | Maximum |
|--------------------------|-----------------|---------------|---------------|---------|---------|---------|
| Forward Voltage          | $V_F$           | $I_F = 20$ mA | V             |         | 3.2     | 4.0     |
| Reverse Current          | $I_R$           | $V_R = 5$ V   | $\mu\text{A}$ |         |         | 10      |
| Luminous Intensity       | $I_V$           | $I_F = 20$ mA | mcd           | 710     | 1600    |         |
| Chromaticity Coordinates | x               | $I_F = 20$ mA |               |         | 0.3100  |         |
|                          | y               | $I_F = 20$ mA |               |         | 0.3200  |         |
| 50% Power Angle          | $2\theta_{1/2}$ | $I_F = 20$ mA | deg           |         | 120     |         |



## Intensity Bin Limit ( $I_F = 20 \text{ mA}$ )

Cool White

| Bin Code | Min.(mcd) | Max.(mcd) |
|----------|-----------|-----------|
| Va       | 710       | 900       |
| Vb       | 900       | 1120      |
| Wa       | 1120      | 1400      |
| Wb       | 1400      | 1800      |
| Xa       | 1800      | 2240      |

Tolerance of measurement of luminous intensity is  $\pm 10\%$ .

## VF Bin Limit ( $I_F = 20 \text{ mA}$ )

Cool White

| Bin Code | Min.(V) | Max.(V) |
|----------|---------|---------|
| 27       | 2.8     | 3.0     |
| 28       | 3.0     | 3.2     |
| 29       | 3.2     | 3.4     |
| 2a       | 3.4     | 3.6     |
| 2b       | 3.6     | 3.8     |
| 2c       | 3.8     | 4.0     |

Tolerance of measurement of VF is  $\pm 0.05V$ .

## Color Bin Limit ( $I_F = 20 \text{ mA}$ )

| Bin Code | Sub-bin | x      | y      |
|----------|---------|--------|--------|
| W1       | Wa      | 0.2545 | 0.2480 |
|          |         | 0.2633 | 0.2410 |
|          |         | 0.2545 | 0.2245 |
|          |         | 0.2450 | 0.2290 |
|          | Wb      | 0.2633 | 0.2410 |
|          |         | 0.2720 | 0.2340 |
|          |         | 0.2640 | 0.2200 |
|          |         | 0.2545 | 0.2245 |
|          | Wc      | 0.2545 | 0.2480 |
|          |         | 0.2640 | 0.2670 |
|          |         | 0.2720 | 0.2575 |
|          |         | 0.2633 | 0.2410 |
|          | Wd      | 0.2633 | 0.2410 |
|          |         | 0.2720 | 0.2575 |
|          |         | 0.2800 | 0.2480 |
|          |         | 0.2720 | 0.2340 |
| W2       | We      | 0.2640 | 0.2670 |
|          |         | 0.2735 | 0.2860 |
|          |         | 0.2808 | 0.2740 |
|          |         | 0.2720 | 0.2575 |
|          | Wf      | 0.2720 | 0.2575 |
|          |         | 0.2808 | 0.2740 |
|          |         | 0.2880 | 0.2620 |
|          |         | 0.2800 | 0.2480 |
|          | Wg      | 0.2735 | 0.2860 |
|          |         | 0.2830 | 0.3050 |
|          |         | 0.2895 | 0.2905 |
|          |         | 0.2808 | 0.2740 |
| Wh       | 0.2808  | 0.2740 |        |
|          | 0.2895  | 0.2905 |        |
|          | 0.2960  | 0.2760 |        |
|          | 0.2880  | 0.2620 |        |

| Bin Code | Sub-bin | x      | y      |
|----------|---------|--------|--------|
| W3       | Wj      | 0.2830 | 0.3050 |
|          |         | 0.2950 | 0.3210 |
|          |         | 0.2998 | 0.3028 |
|          |         | 0.2895 | 0.2905 |
|          | Wk      | 0.2895 | 0.2905 |
|          |         | 0.2998 | 0.3028 |
|          |         | 0.3045 | 0.2865 |
|          |         | 0.2960 | 0.2760 |
|          | Wm      | 0.2950 | 0.3210 |
|          |         | 0.3070 | 0.3370 |
|          |         | 0.3100 | 0.3150 |
|          |         | 0.2998 | 0.3028 |
| Wn       | 0.2998  | 0.3028 |        |
|          | 0.3100  | 0.3150 |        |
|          | 0.3130  | 0.2970 |        |
|          | 0.3045  | 0.2865 |        |
| W4       | Wp      | 0.3070 | 0.3370 |
|          |         | 0.3185 | 0.3485 |
|          |         | 0.3200 | 0.3270 |
|          |         | 0.3100 | 0.3150 |
|          | Wq      | 0.3100 | 0.3150 |
|          |         | 0.3200 | 0.3270 |
|          |         | 0.3215 | 0.3075 |
|          |         | 0.3130 | 0.2970 |
|          | Wr      | 0.3185 | 0.3485 |
|          |         | 0.3300 | 0.3600 |
|          |         | 0.3300 | 0.3390 |
|          |         | 0.3200 | 0.3270 |
| Ws       | 0.3200  | 0.3270 |        |
|          | 0.3300  | 0.3390 |        |
|          | 0.3300  | 0.3180 |        |
|          | 0.3215  | 0.3075 |        |

| Bin Code | Sub-bin | x      | y      |
|----------|---------|--------|--------|
| W5       | Wt      | 0.3300 | 0.3600 |
|          |         | 0.3455 | 0.3725 |
|          |         | 0.3443 | 0.3535 |
|          |         | 0.3300 | 0.3390 |
|          | Wu      | 0.3300 | 0.3390 |
|          |         | 0.3443 | 0.3535 |
|          |         | 0.3430 | 0.3345 |
|          |         | 0.3300 | 0.3180 |
|          | Wv      | 0.3455 | 0.3725 |
|          |         | 0.3610 | 0.3850 |
|          |         | 0.3585 | 0.3680 |
|          |         | 0.3443 | 0.3535 |
| Ww       | 0.3443  | 0.3535 |        |
|          | 0.3585  | 0.3680 |        |
|          | 0.3560  | 0.3510 |        |
|          | 0.3430  | 0.3345 |        |

Tolerance of measurement of the color coordinates is  $\pm 0.01$ .

## CIE Chromaticity Diagram

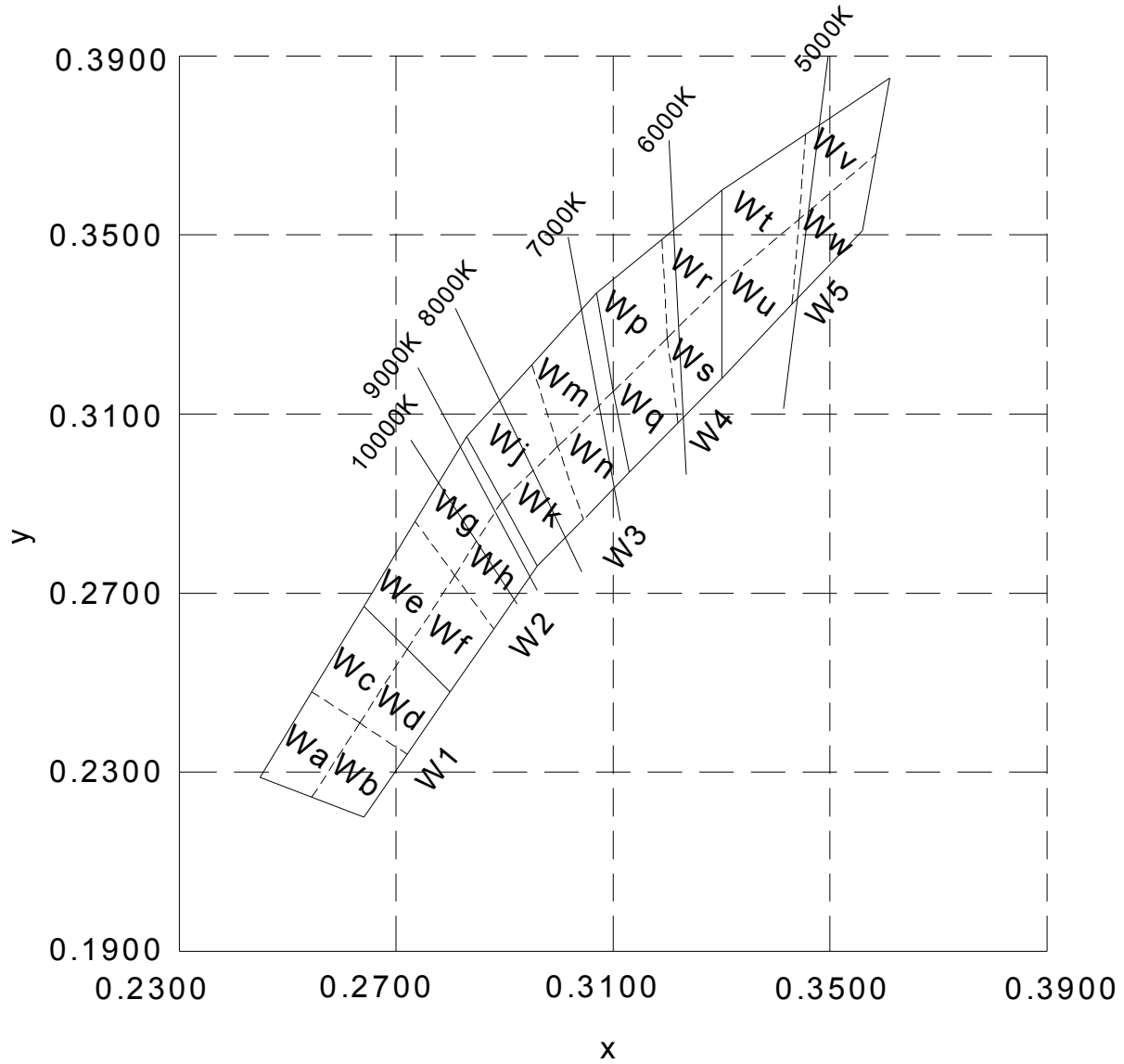



## Order Code Table\*

| Color      | Kit Number         | Viewing Angle | Luminous Intensity (mcd) |      | Color Bin Code |
|------------|--------------------|---------------|--------------------------|------|----------------|
|            |                    |               | Min.                     | Max. |                |
| Cool white | CLM1C-WKW-CVaXa153 | 120           | 710                      | 2240 | W1,W2,W3,W4,W5 |
| Cool white | CLM1C-WKW-CVaWb153 | 120           | 710                      | 1800 | W1,W2,W3,W4,W5 |
| Cool white | CLM1C-WKW-CVbWb233 | 120           | 900                      | 1800 | W2,W3          |
| Cool white | CLM1C-WKW-CVbWb453 | 120           | 900                      | 1800 | W4,W5          |
| Cool white | CLM1C-WKW-CWaWb233 | 120           | 1120                     | 1800 | W2,W3          |
| Cool white | CLM1C-WKW-CWaWb453 | 120           | 1120                     | 1800 | W4,W5          |

### Notes:

1. The above kit numbers represent order codes which include multiple intensity-bin and color-bin codes. Only one intensity-bin code and one color-bin code will be shipped on each reel. Single intensity-bin code and single color-bin codes will not be orderable.
2. Please refer to the "Cree LED Lamp Reliability Test Standards" document for reliability test conditions.
3. Please refer to the "Cree LED Lamp Soldering & Handling" document for information about how to use this LED product safely.

# Graphs

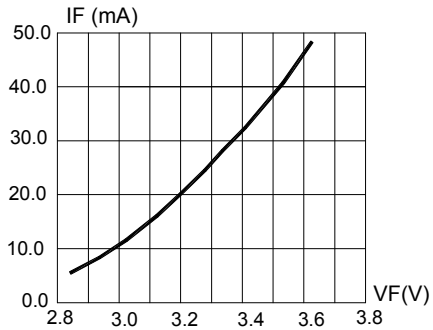

FIG.1 FORWARD CURRENT VS. FORWARD VOLTAGE.

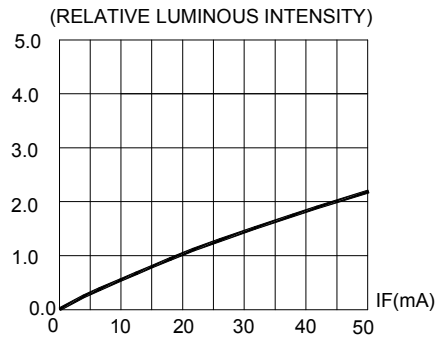

FIG.2 RELATIVE LUMINOUS INTENSITY VS. FORWARD CURRENT

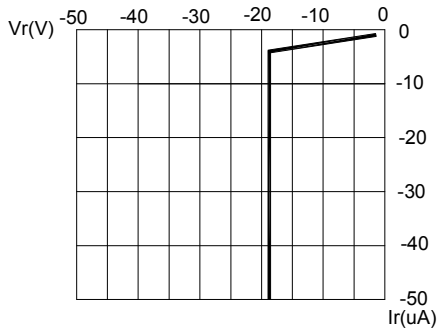

FIG.3 REVERSE CURRENT VS. REVERSE VOLTAGE.

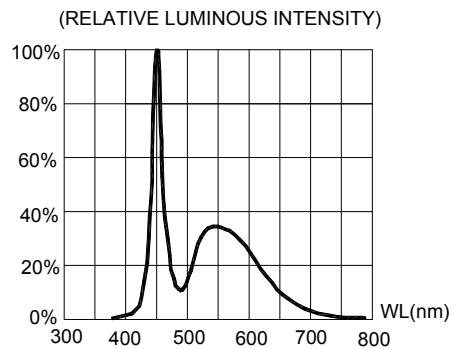

FIG.4 RELATIVE LUMINOUS INTENSITY VS. WAVELENGTH.

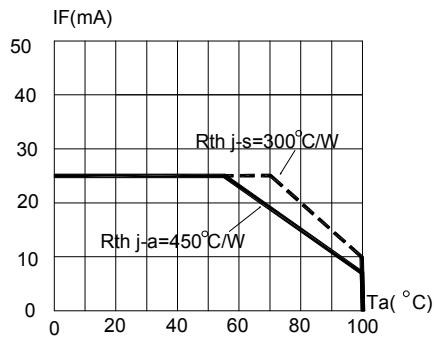

FIG.5 MAXIMUM FORWARD DC CURRENT VS AMBIENT TEMPERATURE ( $T_{jmax}=110^{\circ}C$ )

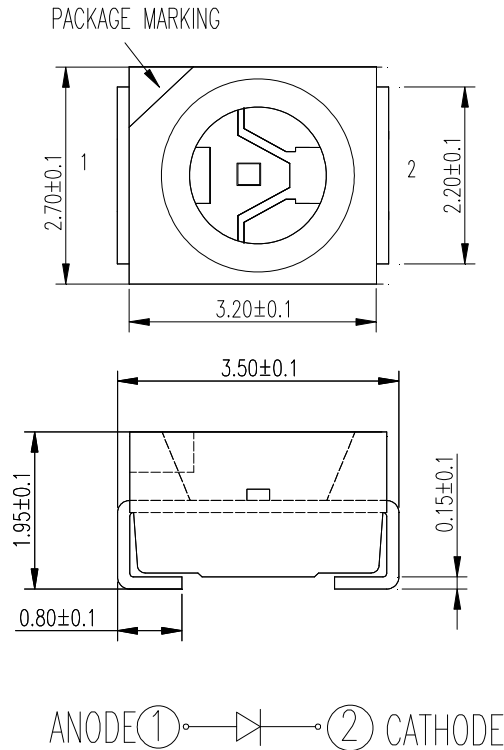

FIG.6 FAR FIELD PATTERN

The above data are collected from statistical figures which do not necessarily correspond to the actual parameters of each single LED. Hence, these data will be changed without further notice.

## Mechanical Dimensions

All dimensions are in mm.



## Notes

### RoHS Compliance

The levels of environmentally sensitive, persistent biologically toxic (PBT), persistent organic pollutants (POP), or otherwise restricted materials in this product are below the maximum concentration values (also referred to as the threshold limits) permitted for such substances, or are used in an exempted application, in accordance with EU Directive 2002/95/EC on the restriction of the use of certain hazardous substances in electrical and electronic equipment (RoHS), as amended through April 21, 2006.

### Vision Advisory Claim

Users should be cautioned not to stare at the light of this LED product. The bright light can damage the eye.

## Kit Number System

Cree LED lamps are tested and sorted into performance bins. A bin is specified by ranges of color, forward voltage, and brightness. Sorted LEDs are packaged for shipping in various convenient options. Please refer to the "Cree LED Lamp Packaging Standard" document for more information about shipping and packaging options.

Cree LEDs are sold by order codes in combinations of bins called kits. Order codes are configured in the following manner:

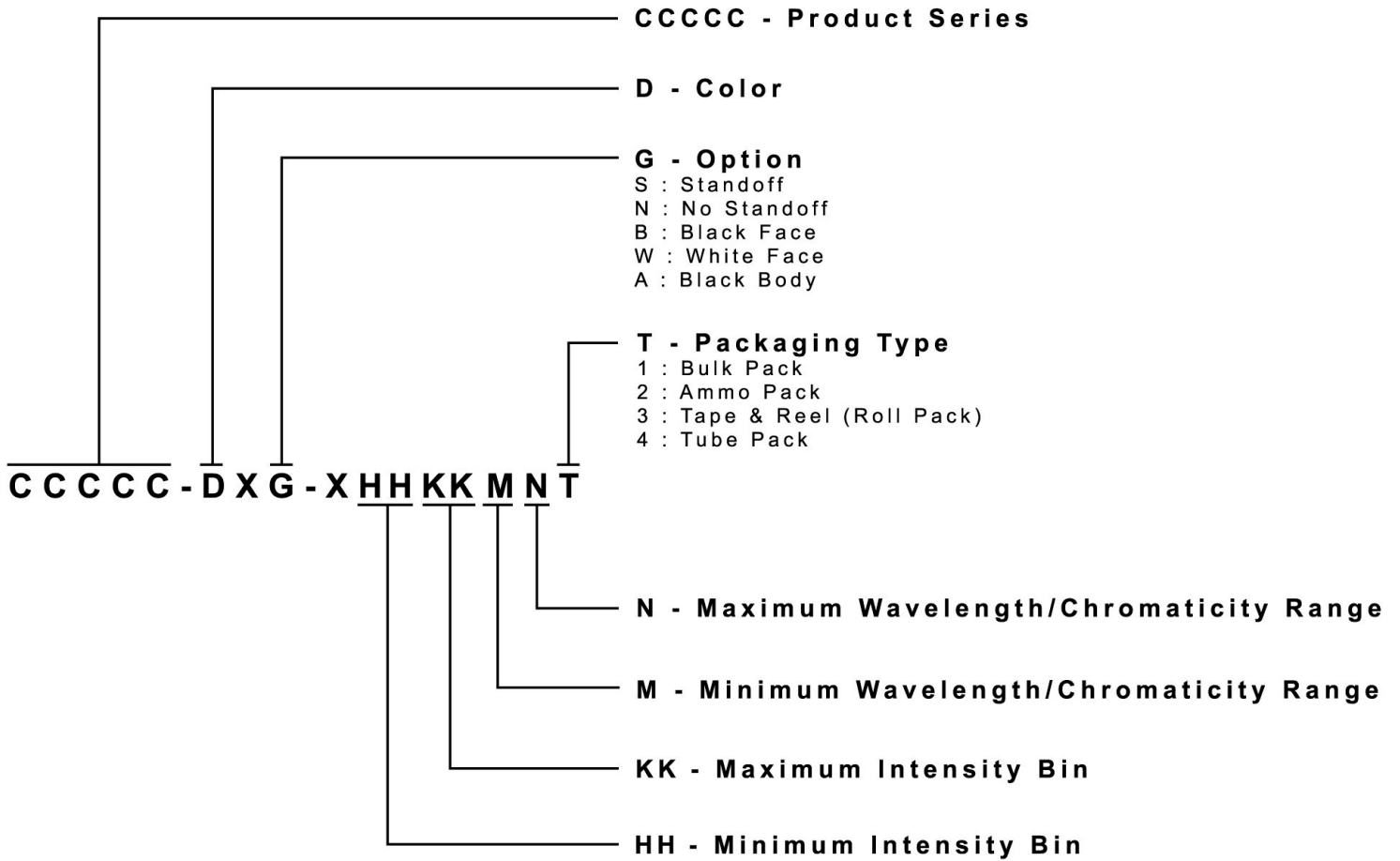



## Packaging

- The boxes are not water resistant and they must be kept away from water and moisture.
- The LEDs are packed in cardboard boxes after packaging in normal or anti-electrostatic bags.
- Cardboard boxes will be used to protect the LEDs from mechanical shocks during transportation.
- The reel pack is applied in SMD LED.
- Max 2000 pcs per reel.

