

# 4-Pin Super Flux Red/Green LED Lamp Orca R Series (Flat Face)

# BIVAR

## R50RG2-F-0160

- ◆ RoHS Compliant
- ◆ Low Profile Dome Lens
- ◆ Automatic Insertion Compatible — Tubular Packaging
- ◆ Automatic Placement Compatible
- ◆ High Intensity Output
- ◆ High Power Efficiency



Bivar **R50RG2-F-0160** comes with low profile package design incorporating higher forward current to maximize intensity while minimizing the number of LEDs required to achieve uniform and enhanced light distribution. Low power consumption with quick response time means savings in electricity.

Bivar **R50RG2-F-0160** can be coupled with reflectors or lenses for optimal light distribution needs. Typical applications are automotive exterior lighting, decorative interior or exterior lighting, specialty stage lighting, and electronic signage.

Part Number	Material	Emitted Color	Lumen Typ. mcd	Lens Color	Viewing Angle
R50RG2-F-0160	AlGaInP/GaAs	Red	600	Water Clear	160°
	InGaN/Sapphire	Green	800		

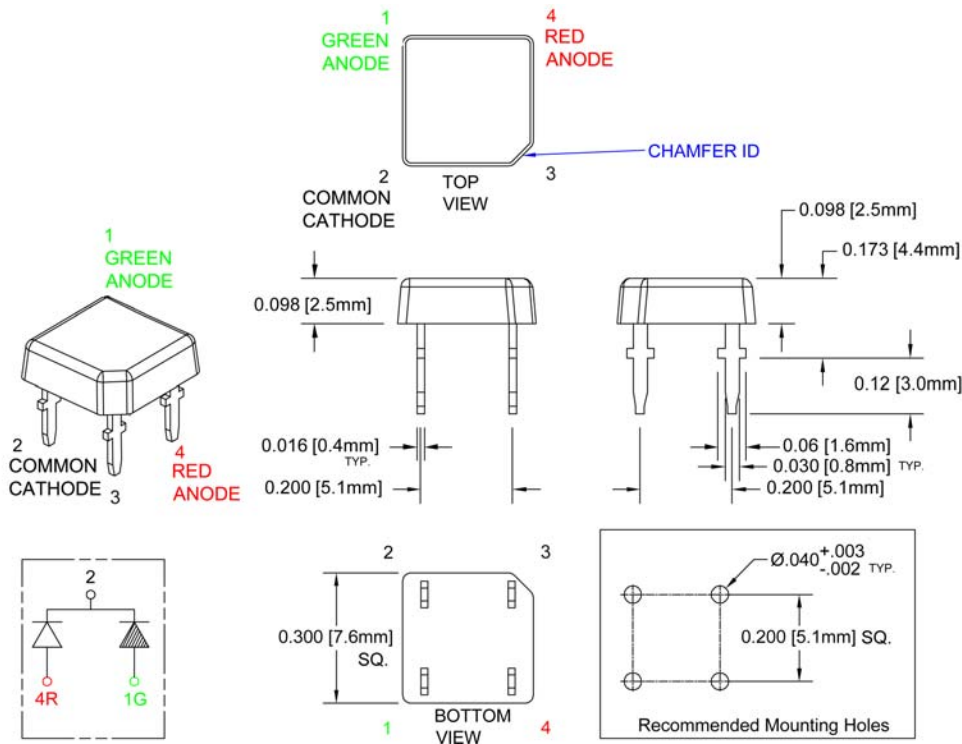

### Outline Drawings Notes:

1. All dimensions are in inches [millimeters].
2. Standard tolerance:  $\pm 0.010$ " unless otherwise noted.
3. Tolerance of overall epoxy outline:  $\pm 0.020$ " unless otherwise noted.
4. Epoxy meniscus may extend to 0.060" max.



**CAUTION: LOOKING DIRECTLY AT LED WITHOUT SHIELDED EYES MAY CAUSE DAMAGE TO RETINA.**

Bivar reserves the right to make changes at any time.

# 4-Pin Super Flux Red/Green LED Lamp R50RG2-F-0160



## Absolute Maximum Ratings

T<sub>A</sub> = 25°C unless otherwise noted

Power Dissipation	R - 150 mW G - 220 mW
Forward Current ( DC )	80 mA
Peak Forward Current <sup>1</sup>	R - 160 mA G - 150 mA
Electrostatic Discharge ( Class1 )	R - 1000 V G - 1000 V
Reverse Voltage	5 V
Operating Temperature Range	-25 ~ +80°C
Storage Temperature Range	-30 ~ +80°C
Lead Soldering Temperature ( 3 mm from the base of the epoxy bulb ) <sup>2</sup>	260°C

Notes: 1. 10% Duty Cycle, Pulse Width ≤ 0.1 msec. 2. Solder time less than 5 seconds at temperature extreme.

## Electrical Characteristics

T<sub>A</sub> = 25°C & I<sub>F</sub> = 50 mA unless otherwise noted

Emitting Color	Forward Voltage (V) <sup>1</sup>			Recommend Forward Current (mA)	Reverse Current (μA) V <sub>R</sub> =5V	Dominant Wavelength (nm) <sup>2</sup>		Luminous Intensity (mcd) <sup>3</sup>		Viewing Angle 2 Θ ½ (deg)
	MIN	TYP	MAX	TYP	MAX	MIN	MAX	MIN	TYP	TYP
Red	2.2	2.6	3.0	50	10	620	635	400	600	160
Green	3.4	3.8	4.4	50	10	515	525	600	800	160

Notes: 1. Tolerance of Forward Voltage : ±0.05V.  
2. Tolerance of Dominant Wavelength : ±0.1nm.  
3. Tolerance of Luminous Intensity : ±15%.

## Directivity Radiation

T<sub>A</sub> = 25°C unless otherwise noted

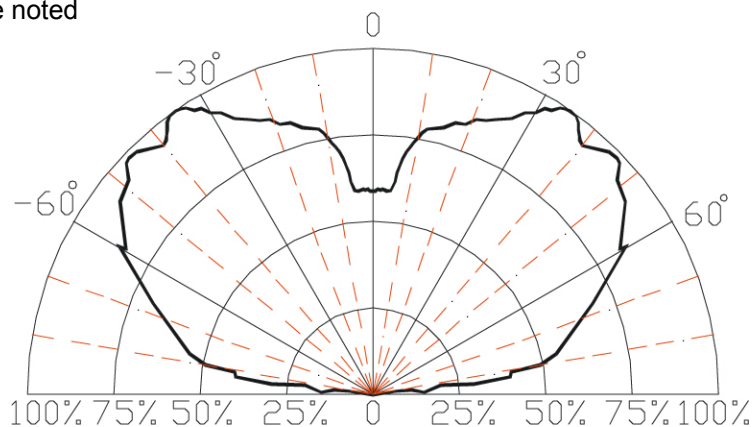

Relative Luminous Intensity vs. Radiation Angle

Bivar reserves the right to make changes at any time.

# 4-Pin Super Flux Red/Green LED Lamp R50RG2-F-0160



## Typical Electrical / Optical Characteristics Curves

$T_A = 25^\circ\text{C}$  unless otherwise noted

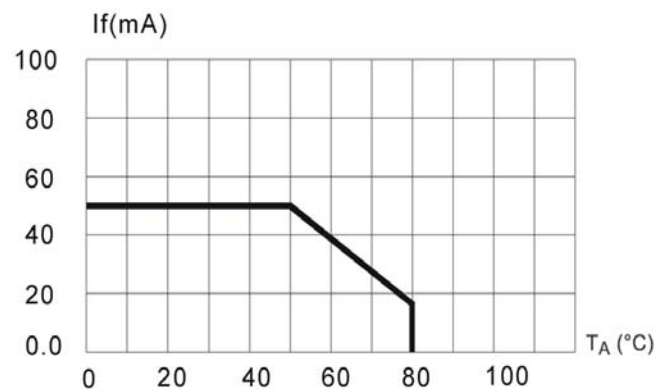
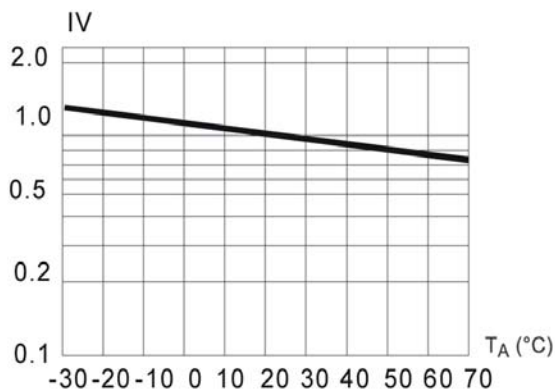
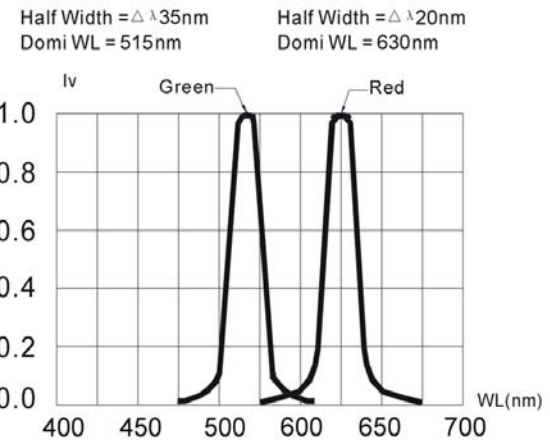
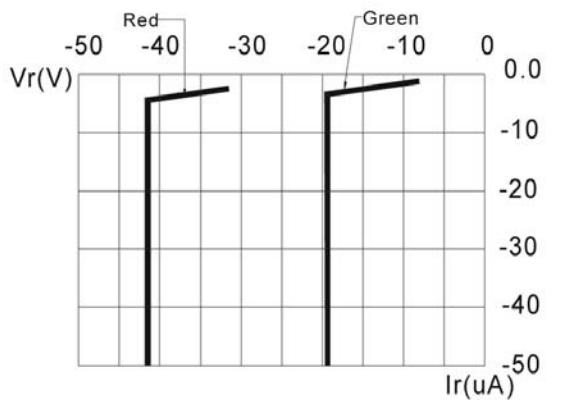
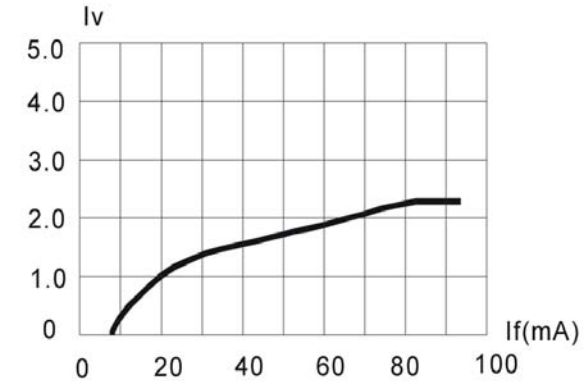
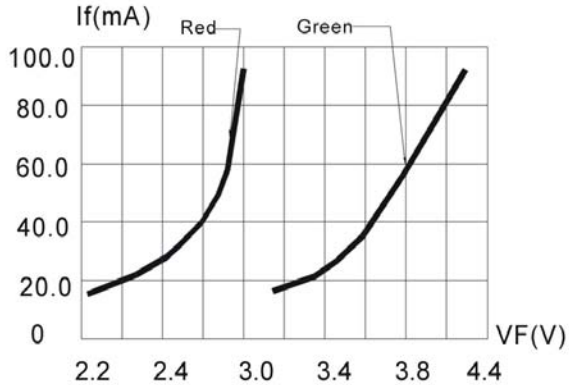

Bivar reserves the right to make changes at any time.

# 4-Pin Super Flux Red/Green LED Lamp R50RG2-F-0160



## Recommended Soldering Conditions



Recommended Lead Free Wave Soldering Profile	
Preheat Temperature: 100°C Max.	Peak Temperature: 260°C Max.
Preheat Time: 20 ~ 50 Seconds	Solder Time Above 217°C: 5 Seconds Max.
Note: Turn off top heater at preheat to prevent the lamp body directly exposed to the heat source.	

## Packaging and Labeling Plan

Bivar Orca R series Super Flux LEDs are packaged in tubes, each of which contains 60 LEDs; and each tube contains a rubber stopper at each end.

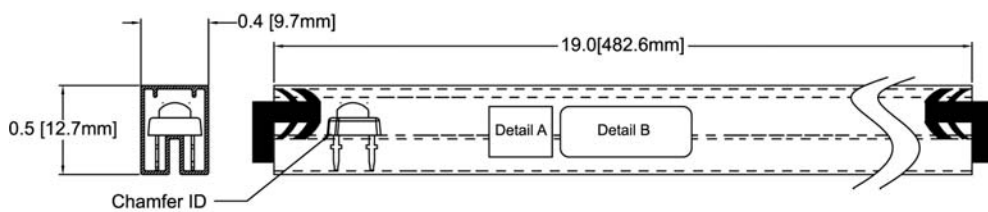

Detail A

Note: 60 pcs Max./Antistatic Tube

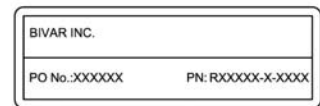

Detail B

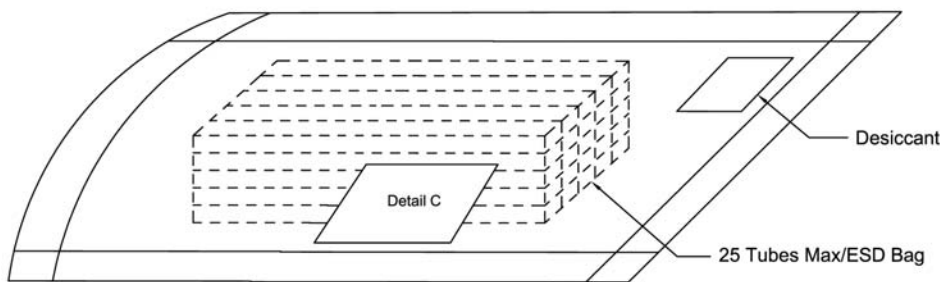

Note: 1500 pcs Max/ESD bag



Detail C

Bivar reserves the right to make changes at any time.