

Part Number: APHBM2012CGKSYKC

Green  
Super Bright Yellow

### Features

- 2.0mmx1.25mm SMT LED, 0.45mm max. thickness.
- Bi-color, low power consumption.
- Wide viewing angle.
- Ideal for backlight and indicator.
- Package : 2000pcs / reel.
- Moisture sensitivity level : level 3.
- RoHS compliant.

### Description

The Green source color devices are made with AlGaInP on GaAs substrate Light Emitting Diode.

The Super Bright Yellow device is made with AlGaInP (on GaAs substrate) light emitting diode chip.

### Package Dimensions

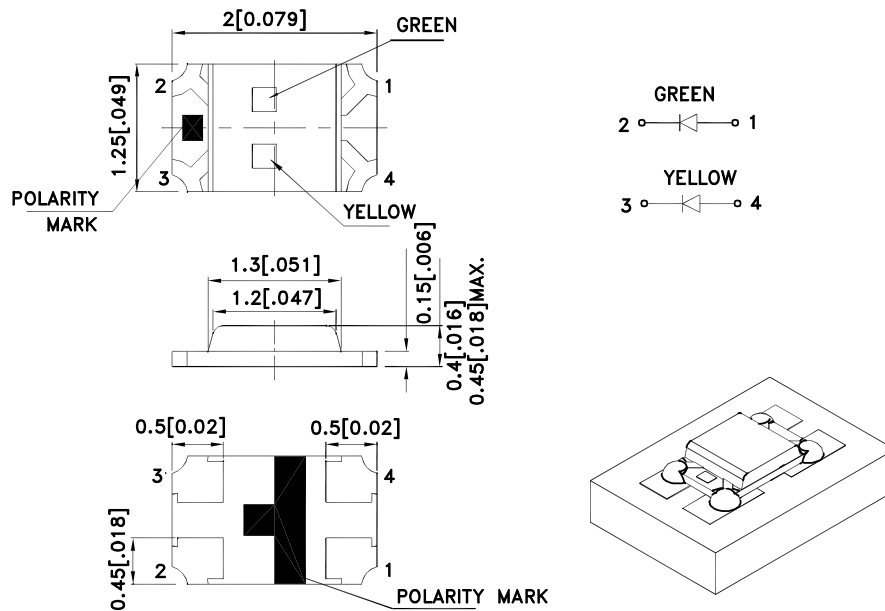

#### Notes:

1. All dimensions are in millimeters (inches).
2. Tolerance is  $\pm 0.1(0.004)$  unless otherwise noted.
3. The specifications, characteristics and technical data described in the datasheet are subject to change without prior notice.
4. The device has a single mounting surface. The device must be mounted according to the specifications.



## Selection Guide

Part No.	Dice	Lens Type	Iv (mcd) [2] @ 20mA		Viewing Angle [1]
			Min.	Typ.	2θ1/2
APHBM2012CGKSYKC	Green (AlGaInP)	Water Clear	30	55	120°
	Super Bright Yellow (AlGaInP)		80	120	

Notes:

1. θ1/2 is the angle from optical centerline where the luminous intensity is 1/2 of the optical peak value.
2. Luminous intensity/ luminous Flux: +/-15%.

## Electrical / Optical Characteristics at TA=25°C

Symbol	Parameter	Device	Typ.	Max.	Units	Test Conditions
λpeak	Peak Wavelength	Green Super Bright Yellow	574 590		nm	IF=20mA
λD [1]	Dominant Wavelength	Green Super Bright Yellow	570 590		nm	IF=20mA
Δλ1/2	Spectral Line Half-width	Green Super Bright Yellow	20 20		nm	IF=20mA
C	Capacitance	Green Super Bright Yellow	15 20		pF	VF=0V;f=1MHz
VF [2]	Forward Voltage	Green Super Bright Yellow	2.1 2	2.5 2.5	V	IF=20mA
IR	Reverse Current	Green Super Bright Yellow		10 10	uA	VR = 5V

Notes:

1. Wavelength: +/-1nm.
2. Forward Voltage: +/-0.1V.

## Absolute Maximum Ratings at TA=25°C

Parameter	Green	Super Bright Yellow	Units
Power dissipation	75	75	mW
DC Forward Current	30	30	mA
Peak Forward Current [1]	150	175	mA
Reverse Voltage	5		V
Operating Temperature	-40°C To +85°C		
Storage Temperature	-40°C To +85°C		

Note:

1. 1/10 Duty Cycle, 0.1ms Pulse Width.

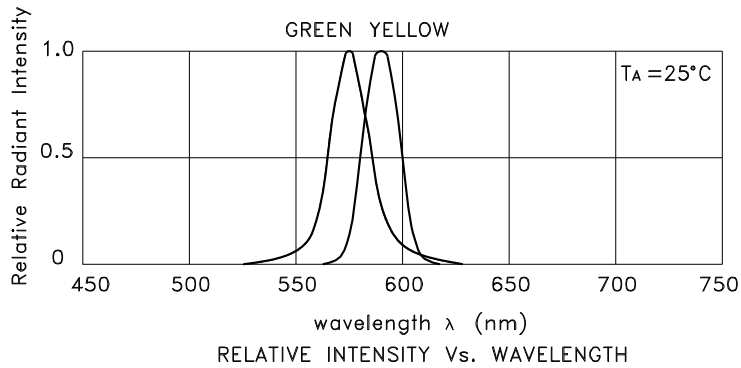

## APHBM2012CGKSYKC Green

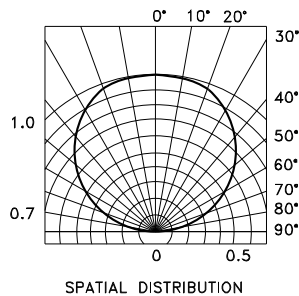
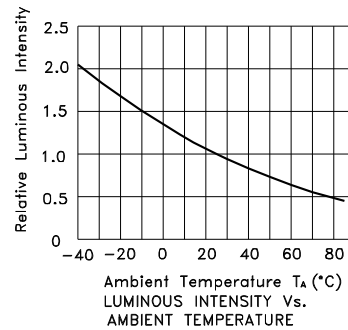
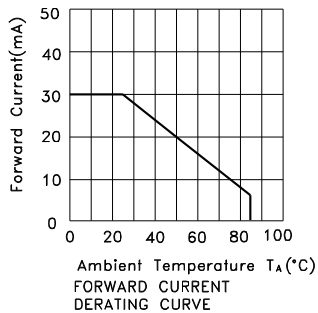
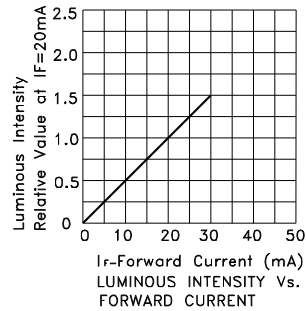
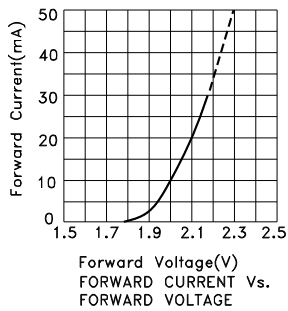

## Super Bright Yellow

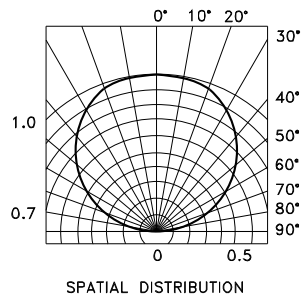
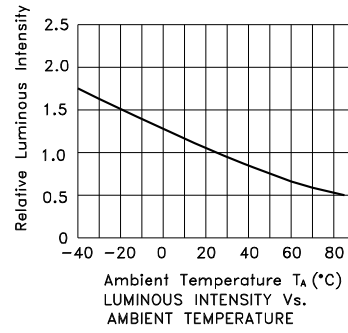
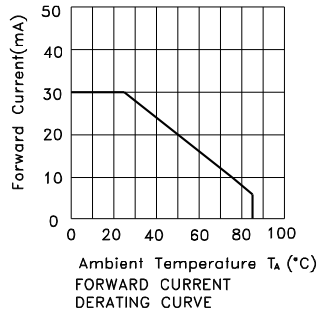
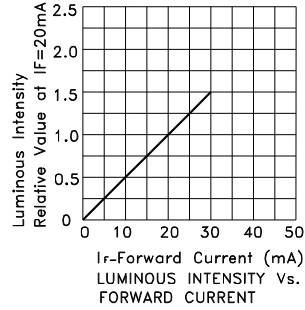
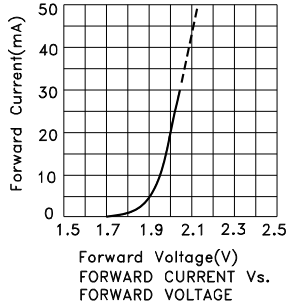

## APHBM2012CGKSYKC

Reflow soldering is recommended and the soldering profile is shown below.  
Other soldering methods are not recommended as they might cause damage to the product.

Reflow Soldering Profile For Lead-free SMT Process.

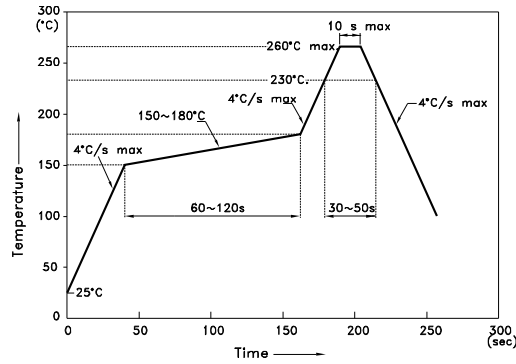

NOTES:

1. We recommend the reflow temperature 245°C(+/-5°C). The maximum soldering temperature should be limited to 260°C.
2. Don't cause stress to the epoxy resin while it is exposed to high temperature.
3. Number of reflow process shall be 2 times or less.

### Recommended Soldering Pattern (Units : mm; Tolerance: ± 0.1)

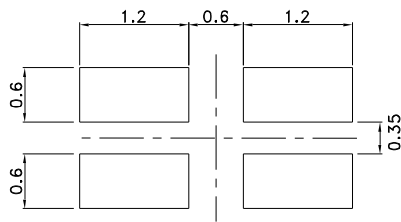

### Reel Dimension

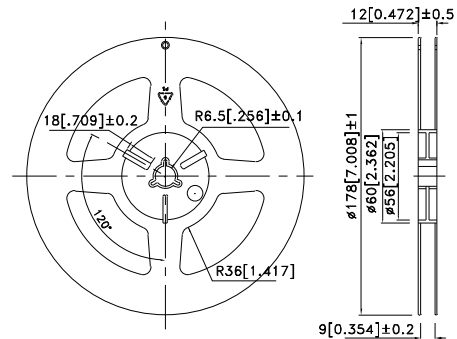

### Tape Dimensions (Units : mm)

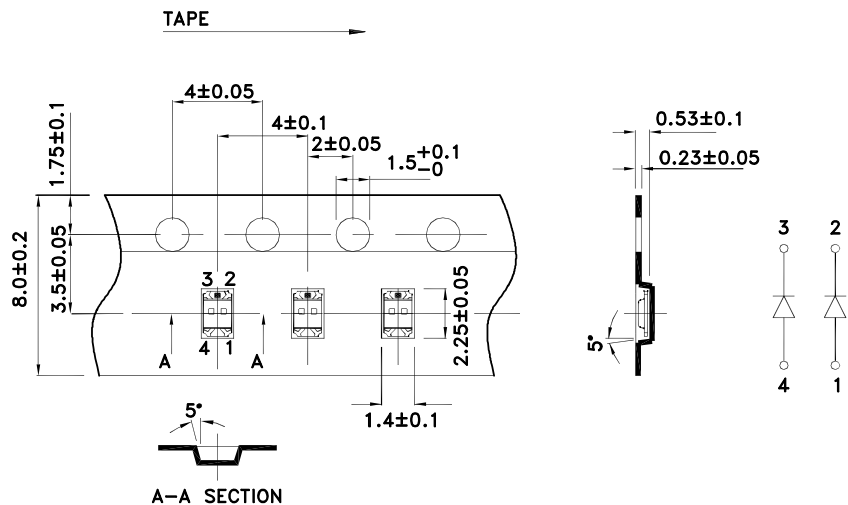

**PACKING & LABEL SPECIFICATIONS**

**APHBM2012CGKSYKC**

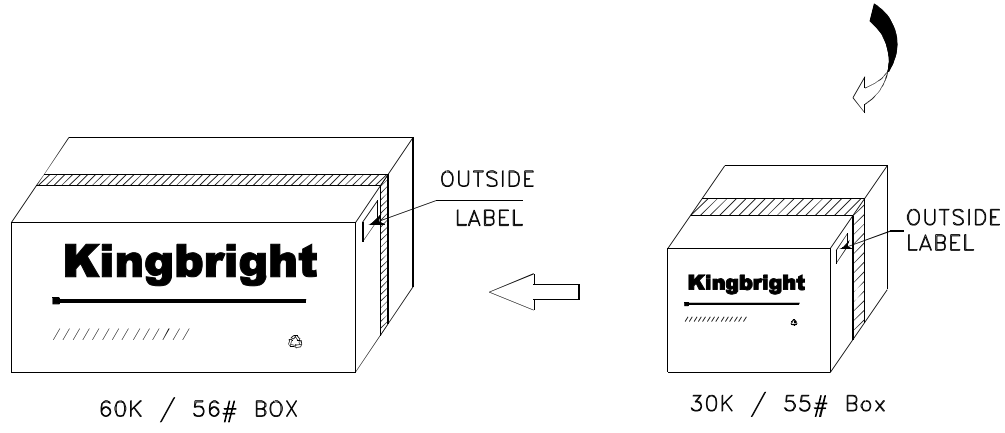
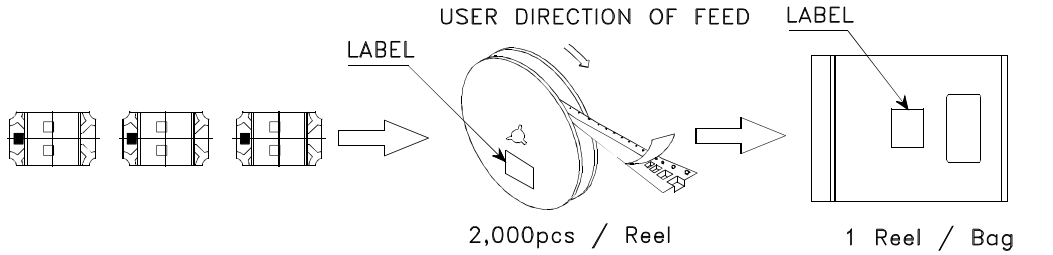

<h2 style="margin: 0;">Kingbright</h2>	
P/NO: APHBM2012xxx	
QTY: 2,000 pcs	Q.C. <span style="border: 1px solid black; border-radius: 50%; padding: 2px;">Q C xx xx xxxx PASSED</span>
S/N: XXXX	
CODE: XXX	
LOT NO:	
 xxxxxxxxxxxxxxxxxxxxxxxx	
RoHS Compliant	

Downloaded from [Elcodis.com](http://Elcodis.com) electronic components distributor