

Part Number: APHCM2012SYCK-F01

Super Bright Yellow

### Features

- 2.0X1.25mm SMT LED, 0.5mm max. thickness.
- Low power consumption.
- Wide viewing angle.
- Ideal for backlight and indicator.
- Various colors and lens types available.
- Package : 2000pcs / reel.
- Moisture sensitivity level : level 3.
- RoHS compliant.

### Description

The Super Bright Yellow device is made with AlGaInP (on GaAs substrate) light emitting diode chip.

### Package Dimensions

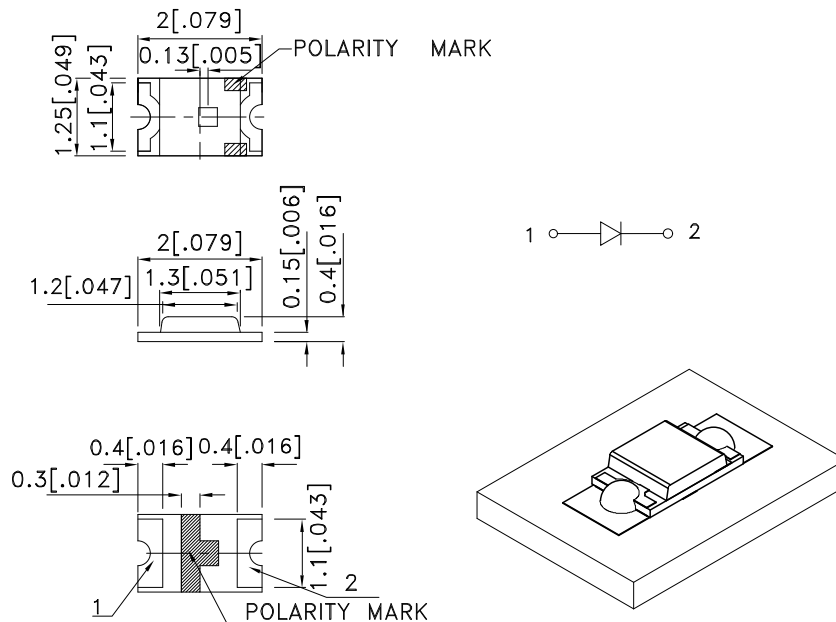

#### Notes:

1. All dimensions are in millimeters (inches).
2. Tolerance is  $\pm 0.1$  (0.004") unless otherwise noted.
3. The specifications, characteristics and technical data described in the datasheet are subject to change without prior notice.
4. The device has a single mounting surface. The device must be mounted according to the specifications.



## Selection Guide

| Part No.          | Dice                          | Lens Type   | Iv (mcd) [2]<br>@ 20mA |      | Viewing<br>Angle [1] |
|-------------------|-------------------------------|-------------|------------------------|------|----------------------|
|                   |                               |             | Min.                   | Typ. | 2θ1/2                |
| APHCM2012SYCK-F01 | Super Bright Yellow (AlGaInP) | Water Clear | 80                     | 150  | 110°                 |

Notes:

1. θ1/2 is the angle from optical centerline where the luminous intensity is 1/2 of the optical peak value.
2. Luminous intensity/ luminous Flux: +/-15%.

## Electrical / Optical Characteristics at TA=25°C

| Symbol | Parameter                | Device              | Typ. | Max. | Units | Test Conditions |
|--------|--------------------------|---------------------|------|------|-------|-----------------|
| λpeak  | Peak Wavelength          | Super Bright Yellow | 590  |      | nm    | IF=20mA         |
| λD [1] | Dominant Wavelength      | Super Bright Yellow | 590  |      | nm    | IF=20mA         |
| Δλ1/2  | Spectral Line Half-width | Super Bright Yellow | 20   |      | nm    | IF=20mA         |
| C      | Capacitance              | Super Bright Yellow | 20   |      | pF    | VF=0V;f=1MHz    |
| VF [2] | Forward Voltage          | Super Bright Yellow | 2    | 2.5  | V     | IF=20mA         |
| IR     | Reverse Current          | Super Bright Yellow |      | 10   | uA    | VR=5V           |

Notes:

1. Wavelength: +/-1nm.
2. Forward Voltage: +/-0.1V.

## Absolute Maximum Ratings at TA=25°C

| Parameter                | Super Bright Yellow | Units |
|--------------------------|---------------------|-------|
| Power dissipation        | 75                  | mW    |
| DC Forward Current       | 30                  | mA    |
| Peak Forward Current [1] | 175                 | mA    |
| Reverse Voltage          | 5                   | V     |
| Operating Temperature    | -40°C To +85°C      |       |
| Storage Temperature      | -40°C To +85°C      |       |

Note:

1. 1/10 Duty Cycle, 0.1ms Pulse Width.

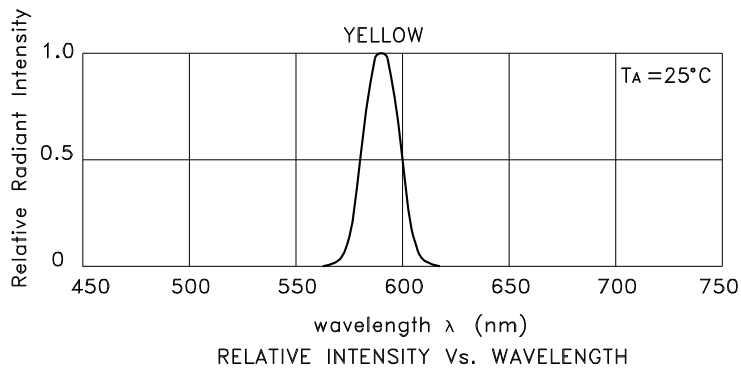

## Super Bright Yellow APHCM2012SYCK-F01

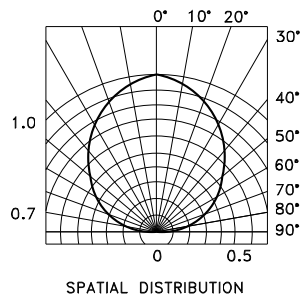
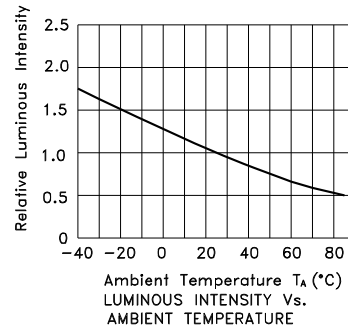
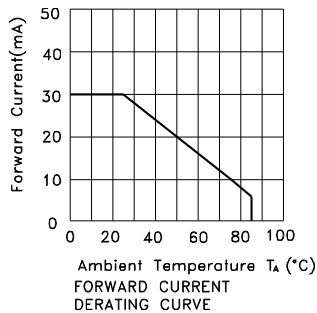
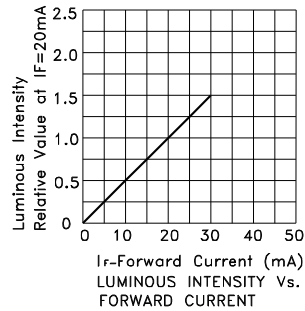
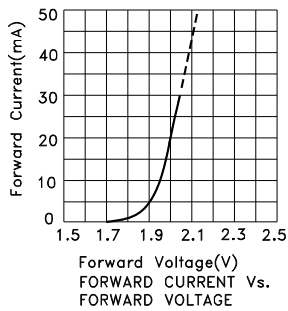





# Kingbright

## PACKING & LABEL SPECIFICATIONS

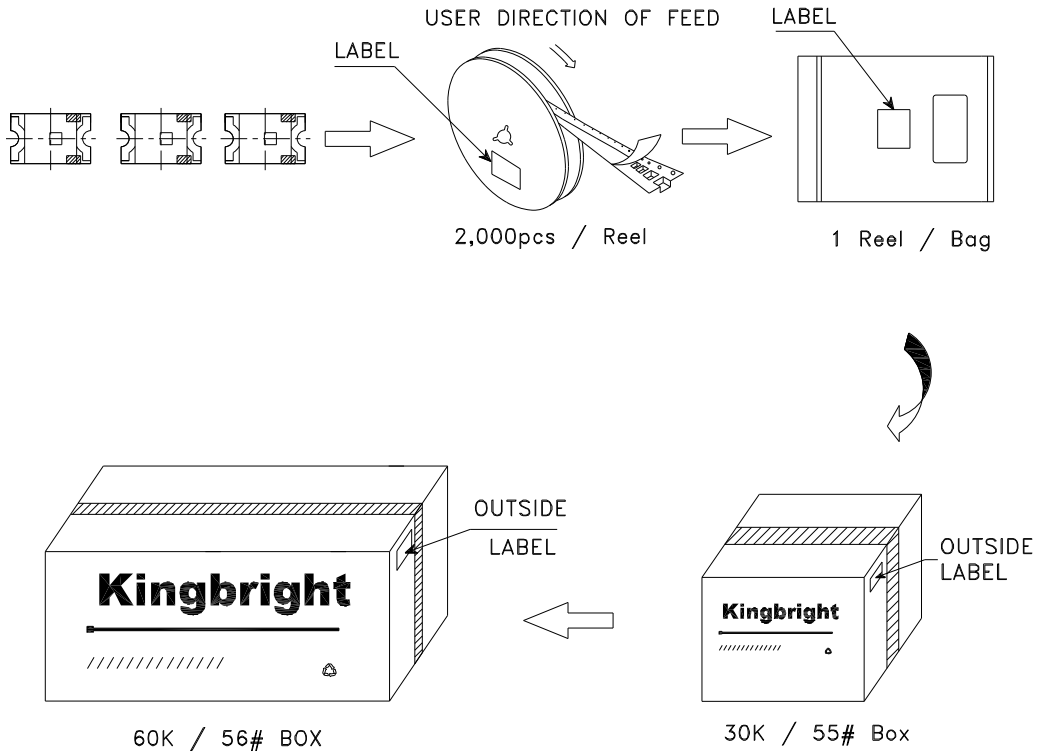
## APHCM2012SYCK-F01



|  |  |
|--|--|
| <b>Kingbright</b>  |  |
| P/NO: APHCM2012xxx   |  |
| QTY: 2,000 pcs   | Q.C. <span style="border: 1px solid black; border-radius: 50%; padding: 2px;">Q C<br/>xx xx xxxx<br/>PASSED</span> |
| S/N: XXXX  |  |
| CODE: XXX  |  |
| LOT NO:  |  |
| <br>xxxxxxxxxxxxxxxxxxxxxxxx |  |
| RoHS Compliant   |  |